

DORMER PRAMET

NUEVOS PRODUCTOS

2024



 DORMER

 PRAMET



NUEVOS PRODUCTOS 2024 – CONTENIDO

2	R003 R023	BROCAS DE METAL DURO VERSÁTILES CON PUNTA RECUBIERTA TIN
10	E397 E398	MACHOS MULTIAPLICACIÓN DE ALTA PRODUCTIVIDAD (DIN)
22	T8415	CALIDAD PVD VERSÁTIL PARA TORNEADO
56	SSO12	FRESADO VERSÁTIL DE ALTO AVANCE
64	E559	MACHOS DE MANO ECONÓMICOS
68	A113	BROCA HSS ACABADO BRILLANTE
73		BARRAS HSS-E
79		INFORMACIÓN TÉCNICA



R003
R023

BROCAS DE METAL DURO VERSÁTILES CON PUNTA RECUBIERTA TIN

INTRODUCCIÓN



Presentamos las nuevas brocas de metal duro Dormer R003 y R023 para uso general, versátiles y con recubrimiento TiN en la punta. Las nuevas características de su diseño dan como resultado un bajo coste por agujero y una excelente consistencia y vida útil de la herramienta. Las brocas Dormer R003 y R023 también ofrecen una baja fuerza de empuje, lo que las hace versátiles tanto para operaciones con máquinas CNC como con máquinas convencionales.

 **DORMER**



R003



- Broca de metal duro serie corta
- Versatilidad, rentabilidad
- Rango métrico: 1 – 14 mm
- Rango imperial: N60 – 1/2"



R023



- Broca de metal duro
- serie extra corta
- Versatilidad, rentabilidad
- Rangop métrico: 1 – 12 mm



HERRAMIENTAS DE TALADRADO

CARACTERÍSTICAS Y VENTAJAS

La punta dividida en cuatro facetas está específicamente diseñada para proporcionar un excelente autocentrado.



FUERZA DE EMPUJE REDUCIDA
facilita la operación manteniendo la precisión.

Recubrimiento de la punta de nitruro de titanio (TiN) sólo en la parte de acción de corte de la broca.



VIDA ÚTIL PROLONGADA Y CONSTANTE
proporciona una fiabilidad rentable.

La tecnología de rectificado CTW proporciona un adelgazamiento continuo del alma a lo largo de todo el canal.



POSIBILIDAD DE RECTIFICADO MÚLTIPLE
sin pérdida de rendimiento en la evacuación de viruta.

Equilibrio entre la geometría del canal y el ángulo de la punta de 120° para lograr un campo de aplicación amplio.



USO VERSÁTIL
tanto en máquinas CNC como convencionales.

Geometría de la punta optimizada con una división en cuatro facetas

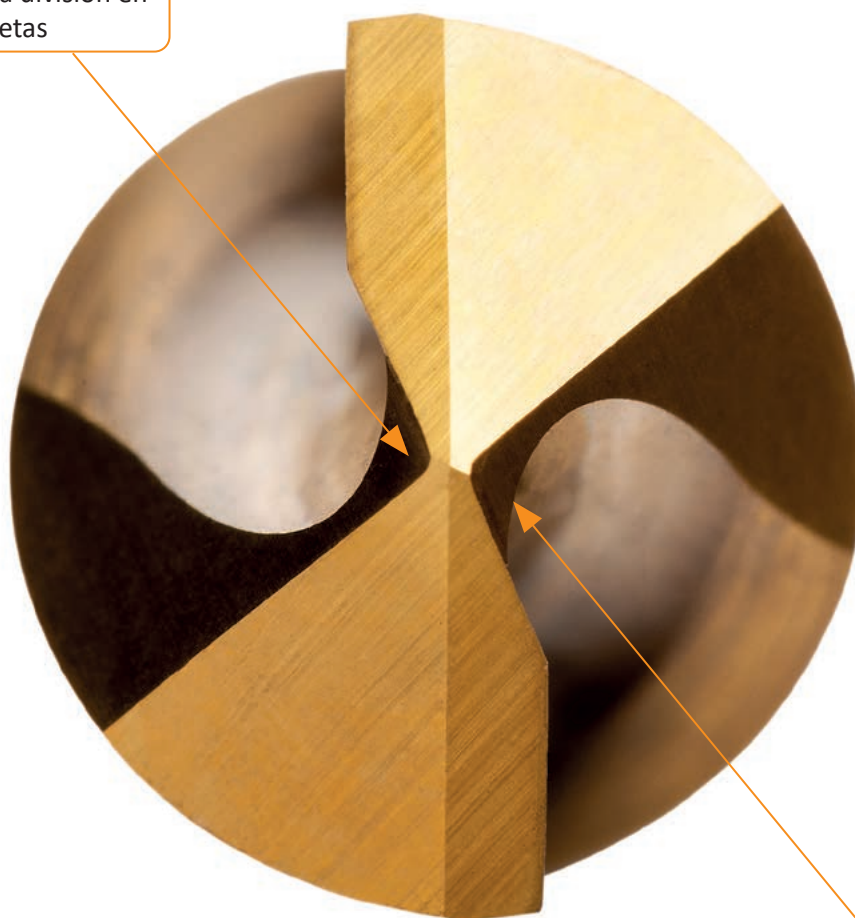

CTW
(Alma continuamente adelgazada)



R003
R023

BROCAS DE METAL DURO VERSÁTILES CON PUNTA RECUBIERTA TIN

HISTORIAS DE ÉXITO – R003 & R023

Segmento: Industria de generación de energía (México)
Componente: Brocas para montaje en taladros eléctricos manuales
Material: SAE 4140 / 1.7225 / 42CrMo4 (acero aleado, 190 HB)
Refrigerante: Sí, externa, emulsión sintética
Aplicación: Taladrado con máquina CNC Haas con picoteo, agujeros pasantes
Resultados anteriores: Actualmente, la mejor broca de la competencia tiene un revestimiento de alta gama y un doble margen, y se describe como una broca de alto rendimiento.

Resultado con R003: El cliente notó una menor fuerza de empuje en comparación con otras herramientas de la competencia. R003 también proporciona una vida útil de la herramienta comparable y un buen acabado del agujero, ¡simplemente mejor rentabilidad!

Solución Dormer Pramet:

R0031/4

Datos de mecanizado:

v_c	f_n	a_p
54	0.2	12.7

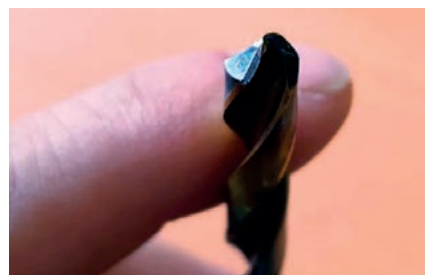

WMG P3.2

Segmento: Subcontratista de maquinaria agrícola (India)
Componente: Volante de inercia de fundición para tractor
Material: FG260 / GG25 (180 – 220 HB)
Refrigerante: En seco, sin refrigerante
Aplicación: Taladrado vertical CNC, agujeros pasantes sin picoteo
Resultados anteriores: La broca de la competencia tenía un desgaste anormal, normalmente después de 260 agujeros la broca no se podía utilizar más, o a veces se rompía prematuramente.

Resultado con R003: La broca Dormer con punta TiN tuvo mejor vida de herramienta comparada con todos los competidores, terminando las pruebas sin roturas o con desgaste excesivo después de 264 agujeros, ¡utilizando los mismos parámetros de corte!

Solución Dormer Pramet:

R0036.8

Datos de mecanizado:

v_c	f_n	a_p
25.6	0.126	30

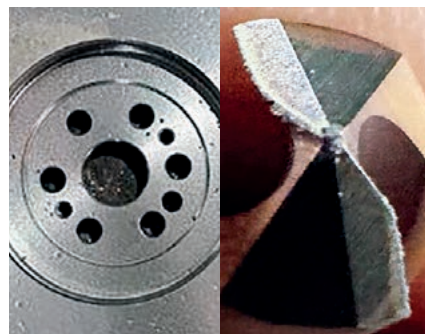

WMG K1.2

Segmento: Productor de piezas de metal en sinterizado (Canadá)
Componente: Placas de fijación
Material: SAE 4340 / 1.6582 / 34CrNiMo6 (acero aleado templado, 53 HRC)
Refrigerante: Sí, externa, emulsión de aceite soluble en agua – taladrina (8%)
Aplicación: Taladro de columna con accionamiento manual, agujeros de posicionamiento.
Resultados anteriores: La broca de la competencia necesita mucha presión manual para penetrar a través del material endurecido, tardaba 30 segundos en hacer el agujero. La broca se desgasta después de 1 agujero.

Resultado con R003: La broca Dormer es capaz de penetrar en el material en sólo 12 segundos con una reducción drástica de la fuerza de taladrado y sigue en buenas condiciones para continuar taladrando.

Solución Dormer Pramet:

R0031/4

Datos de mecanizado:

v_c	f_n	a_p
29	0.08	7.6



WMG H3.1



HERRAMIENTAS DE TALADRADO

Segmento: Subcontratista de piezas de bombas hidráulicas (Italia)
Componente: Válvula de control de caudal hidráulico
Material: 11SMnPb37 / 1.0737 (acero de fácil mecanizado, 145 HB)
Refrigerante: Sí, externa, emulsión de aceite soluble en agua – taladrina (8%)
Aplicación: Pre-taladrado con máquina CNC Bridgeport para rosca M8 y con una profundidad de 35 mm con picoteo
Resultados anteriores: La broca premium de la competencia se ha configurado según las recomendaciones del fabricante ($v_c = 64$ m/min, $f_n = 0.25$ mm/rev), pero la vida útil de la herramienta de 2300 agujeros no es satisfactoria.

Resultado con R003: Nuestra broca supera a las brocas premium de la competencia gracias a una vida útil de la herramienta ligeramente superior y también a su productividad, ¡demostrando ser, rentablemente, la mejor opción para el trabajo!

Solución Dormer Pramet:

R0036.8

Datos de mecanizado:

v_c	f_n	a_p
96	0.2	35



WMG P1.3

Segmento: Subcontratista de piezas de maquinaria (China)
Componente: Caja de cambios
Material: C45 / 1.0503 (Acero al carbono, 225 HB)
Refrigerante: Sí, externa, emulsión de aceite soluble en agua – taladrina (8%)
Aplicación: Máquina vertical CNC, agujeros pasantes
Resultados anteriores: Pruebas a largo plazo para evaluar con precisión el coste por agujero en el trabajo más habitual: taladrado de cajas de acero.

Resultado con R003: Nuestra broca con punta de TiN logró una vida útil +15% superior a la de una broca similar de la competencia y un número de agujeros muy próximo al de una broca de primera calidad de la competencia.

Solución Dormer Pramet:

R0032.5

Datos de mecanizado:

v_c	f_n	a_p
90	0.05	4



WMG P2.1

Segmento: Mecanizado general, subcontratista de piezas de automóvil (Italia)
Componente: Acoplamiento para eje
Material: 11SMnPb37 / 1.0737 (acero de fácil mecanizado, 145 HB)
Refrigerante: Sí, externa, emulsión de aceite soluble en agua – taladrado (8%)
Aplicación: Pretaladrado en torno CNC Doosan para rosca M3 y con una profundidad de corte de 12 mm con picoteo
Resultados anteriores: La broca de metal duro sin recubrimiento de la competencia tenía una vida útil estable de 1400 piezas de trabajo con $v_c = 27$ m/min. Fue difícil reafilarse la broca después, ya que estaba casi destruida.

Resultado con R003: Nuestra broca con punta recubierta de TiN terminó todo un lote de 2000 piezas sin desgaste visible con una velocidad de corte aún mayor, mejorando la productividad en un 48%.

Solución Dormer Pramet:

R0032.8

Datos de mecanizado:

v_c	f_n	a_p
40	0.08	4

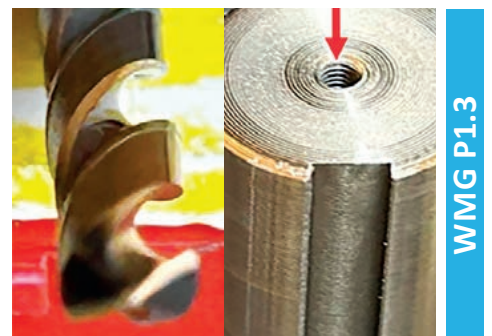

WMG P1.3



R003



Broca de metal duro, punta recubierta TiN

Broca básica y versátil con ángulo de punta de 120° y geometría de punta dividida en cuatro facetas para reducir la fuerza de empuje. Tecnología CTW para mejorar la velocidad de taladrado. El recubrimiento TiN de la punta mejora el rendimiento y prolonga la vida útil de la herramienta. Adecuada para máquinas CNC y convencionales en el taladrado de una amplia gama de materiales.

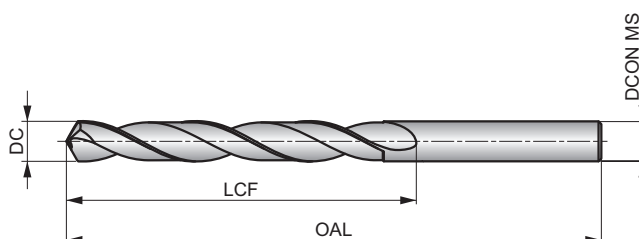

HM	DIN 338	4xD
120°	TiN-Tip	
λ 20-35°	R	DC h7

Grupo de Material de la pieza adecuado y condiciones de velocidad de corte iniciales (m/min) y código de avance alfabético. Tablas con avance por revolución a partir de la pag. 10.

P1.1 ■ 99 S	P1.2 ■ 111 S	P1.3 ■ 115 S	P2.1 ■ 85 S	P2.2 ■ 75 S	P2.3 ■ 66 S	P3.1 ■ 66 S	P3.2 ■ 53 S	P3.3 ■ 45 S	P4.1 ■ 40 S	P4.2 ■ 34 S	P4.3 ■ 27 S	K1.1 ■ 75 T	K1.2 ■ 56 T
K1.3 ■ 42 T	K2.1 ■ 68 T	K2.2 ■ 55 T	K2.3 ■ 44 T	K3.1 ■ 60 T	K3.2 ■ 46 T	K3.3 ■ 37 T	K4.1 ■ 55 T	K4.2 ■ 42 T	K4.3 ■ 31 T	K4.4 ■ 26 T	K4.5 ■ 22 T	K5.1 ■ 63 T	K5.2 ■ 47 T
K5.3 ■ 37 T	N1.1 ■ 150 V	N1.2 ■ 113 V	N1.3 ■ 75 V	N2.1 ■ 129 V	N2.2 ■ 116 V	N2.3 ■ 84 V	N3.1 ■ 317 V	N3.2 ■ 190 V	N4.1 ■ 60 U	N4.2 ■ 100 U	H1.1 ■ 34 S	H2.1 ■ 20 S	H3.1 ■ 22 S

Producto	DC (inch)	DC (mm)	DC (inch)	LCF (mm)	OAL (mm)	DCON MS (mm)
R0031.0	-	1.00	0.0394	12.0	34.0	1.00
R003N60	N60	1.02	0.0400	12.0	34.0	1.02
R0031.1	-	1.10	0.0433	14.0	36.0	1.10
R003N56	N56	1.18	0.0465	16.0	38.0	1.18
R0033/64	3/64	1.19	0.0469	16.0	38.0	1.19
R0031.2	-	1.20	0.0472	16.0	38.0	1.20
R0031.3	-	1.30	0.0512	16.0	38.0	1.30
R003N54	N54	1.40	0.0550	18.0	40.0	1.40
R0031.4	-	1.40	0.0551	18.0	40.0	1.40
R0031.5	-	1.50	0.0591	18.0	40.0	1.50
R003N53	N53	1.51	0.0595	20.0	43.0	1.51
R0031/16	1/16	1.59	0.0625	20.0	43.0	1.59
R0031.6	-	1.60	0.0630	20.0	43.0	1.60
R003N52	N52	1.61	0.0635	20.0	43.0	1.61
R0031.7	-	1.70	0.0669	20.0	43.0	1.70
R003N51	N51	1.70	0.0670	22.0	46.0	1.70
R003N50	N50	1.78	0.0700	22.0	46.0	1.78
R0031.8	-	1.80	0.0709	22.0	46.0	1.80
R0031.9	-	1.90	0.0748	22.0	46.0	1.90
R003N48	N48	1.93	0.0760	24.0	49.0	1.93
R0035/64	5/64	1.98	0.0781	24.0	49.0	1.98
R003N47	N47	1.99	0.0785	24.0	49.0	1.99
R0032.0	-	2.00	0.0787	24.0	49.0	2.00
R003N46	N46	2.06	0.0810	24.0	49.0	2.06
R0032.1	-	2.10	0.0827	24.0	49.0	2.10
R003N44	N44	2.18	0.0860	27.0	53.0	2.18
R0032.2	-	2.20	0.0866	27.0	53.0	2.20
R003N43	N43	2.26	0.0890	27.0	53.0	2.26

Producto	DC (inch)	DC (mm)	DC (inch)	LCF (mm)	OAL (mm)	DCON MS (mm)
R0032.3	-	2.30	0.0906	27.0	53.0	2.30
R0033/32	3/32	2.38	0.0937	30.0	57.0	2.38
R0032.4	-	2.40	0.0945	30.0	57.0	2.40
R003N41	N41	2.44	0.0960	30.0	57.0	2.44
R0032.5	-	2.50	0.0984	30.0	57.0	2.50
R003N39	N39	2.53	0.0995	30.0	57.0	2.53
R003N38	N38	2.58	0.1015	30.0	57.0	2.58
R0032.6	-	2.60	0.1024	30.0	57.0	2.60
R003N37	N37	2.64	0.1040	30.0	57.0	2.64
R0032.7	-	2.70	0.1063	33.0	61.0	2.70
R003N36	N36	2.71	0.1065	33.0	61.0	2.71
R0037/64	7/64	2.78	0.1094	33.0	61.0	2.78
R0032.8	-	2.80	0.1102	33.0	61.0	2.80
R003N33	N33	2.87	0.1130	33.0	61.0	2.87
R0032.9	-	2.90	0.1142	33.0	61.0	2.90
R003N32	N32	2.95	0.1160	33.0	61.0	2.95
R0033.0	-	3.00	0.1181	33.0	61.0	3.00
R003N31	N31	3.05	0.1200	36.0	65.0	3.05
R0033.1	-	3.10	0.1220	36.0	65.0	3.10
R0031/8	1/8	3.17	0.1250	36.0	65.0	3.17
R0033.2	-	3.20	0.1260	36.0	65.0	3.20
R0033.3	-	3.30	0.1299	36.0	65.0	3.30
R0033.4	-	3.40	0.1339	39.0	70.0	3.40
R003N29	N29	3.45	0.1360	39.0	70.0	3.45
R0033.5	-	3.50	0.1378	39.0	70.0	3.50
R003N28	N28	3.57	0.1405	39.0	70.0	3.57
R0039/64	9/64	3.57	0.1406	39.0	70.0	3.57
R0033.6	-	3.60	0.1417	39.0	70.0	3.60



Producto	DC	DC	DC	LCF	OAL	DCON MS
	(inch)	(mm)	(inch)	(mm)	(mm)	(mm)
R0033.7	–	3.70	0.1457	39.0	70.0	3.70
R003N26	N26	3.73	0.1470	39.0	70.0	3.73
R003N25	N25	3.80	0.1495	43.0	75.0	3.80
R0033.8	–	3.80	0.1496	43.0	75.0	3.80
R0033.9	–	3.90	0.1535	43.0	75.0	3.90
R0035/32	5/32	3.97	0.1563	43.0	75.0	3.97
R0034.0	–	4.00	0.1575	43.0	75.0	4.00
R003N21	N21	4.04	0.1590	43.0	75.0	4.04
R003N20	N20	4.09	0.1610	43.0	75.0	4.09
R0034.1	–	4.10	0.1614	43.0	75.0	4.10
R0034.2	–	4.20	0.1654	43.0	75.0	4.20
R003N19	N19	4.22	0.1660	43.0	75.0	4.22
R0034.3	–	4.30	0.1693	47.0	80.0	4.30
R00311/64	11/64	4.37	0.1719	47.0	80.0	4.37
R003N17	N17	4.39	0.1730	47.0	80.0	4.39
R0034.4	–	4.40	0.1732	47.0	80.0	4.40
R0034.5	–	4.50	0.1772	47.0	80.0	4.50
R003N15	N15	4.57	0.1800	47.0	80.0	4.57
R0034.6	–	4.60	0.1811	47.0	80.0	4.60
R0034.7	–	4.70	0.1850	47.0	80.0	4.70
R0033/16	3/16	4.76	0.1875	52.0	86.0	4.76
R003N12	N12	4.80	0.1890	52.0	86.0	4.80
R0034.8	–	4.80	0.1890	52.0	86.0	4.80
R003N11	N11	4.85	0.1910	52.0	86.0	4.85
R0034.9	–	4.90	0.1929	52.0	86.0	4.90
R003N10	N10	4.92	0.1935	52.0	86.0	4.92
R0035.0	–	5.00	0.1969	52.0	86.0	5.00
R0035.1	–	5.10	0.2008	52.0	86.0	5.10
R003N7	N7	5.11	0.2010	52.0	86.0	5.11
R00313/64	13/64	5.16	0.2031	52.0	86.0	5.16
R0035.2	–	5.20	0.2047	52.0	86.0	5.20
R0035.3	–	5.30	0.2087	52.0	86.0	5.30
R0035.4	–	5.40	0.2126	57.0	93.0	5.40
R003N3	N3	5.41	0.2130	57.0	93.0	5.41
R0035.5	–	5.50	0.2165	57.0	93.0	5.50
R0037/32	7/32	5.56	0.2187	57.0	93.0	5.56
R0035.6	–	5.60	0.2205	57.0	93.0	5.60
R003N2	N2	5.61	0.2210	57.0	93.0	5.61
R0035.7	–	5.70	0.2244	57.0	93.0	5.70
R0035.8	–	5.80	0.2283	57.0	93.0	5.80
R0035.9	–	5.90	0.2323	57.0	93.0	5.90
R00315/64	15/64	5.95	0.2344	57.0	93.0	5.95
R0036.0	–	6.00	0.2362	57.0	93.0	6.00
R0036.1	–	6.10	0.2402	63.0	101.0	6.10
R003C	C	6.15	0.2420	63.0	101.0	6.15
R0036.2	–	6.20	0.2441	63.0	101.0	6.20
R0036.3	–	6.30	0.2480	63.0	101.0	6.30
R0031/4	1/4	6.35	0.2500	63.0	101.0	6.35
R0036.4	–	6.40	0.2520	63.0	101.0	6.40
R0036.5	–	6.50	0.2559	63.0	101.0	6.50
R003F	F	6.53	0.2570	63.0	101.0	6.53
R0036.6	–	6.60	0.2598	63.0	101.0	6.60
R0036.7	–	6.70	0.2638	63.0	101.0	6.70
R00317/64	17/64	6.75	0.2656	69.0	109.0	6.75
R0036.8	–	6.80	0.2677	69.0	109.0	6.80
R0036.9	–	6.90	0.2717	69.0	109.0	6.90

Producto	DC	DC	DC	LCF	OAL	DCON MS
	(inch)	(mm)	(inch)	(mm)	(mm)	(mm)
R003I	I	6.91	0.2720	69.0	109.0	6.91
R0037.0	–	7.00	0.2756	69.0	109.0	7.00
R0037.1	–	7.10	0.2795	69.0	109.0	7.10
R0039/32	9/32	7.14	0.2813	69.0	109.0	7.14
R0037.2	–	7.20	0.2835	69.0	109.0	7.20
R0037.3	–	7.30	0.2874	69.0	109.0	7.30
R0037.4	–	7.40	0.2913	69.0	109.0	7.40
R0037.5	–	7.50	0.2953	69.0	109.0	7.50
R00319/64	19/64	7.54	0.2969	75.0	117.0	7.54
R0037.6	–	7.60	0.2992	75.0	117.0	7.60
R0037.7	–	7.70	0.3031	75.0	117.0	7.70
R0037.8	–	7.80	0.3071	75.0	117.0	7.80
R0037.9	–	7.90	0.3110	75.0	117.0	7.90
R0035/16	5/16	7.94	0.3125	75.0	117.0	7.94
R0038.0	–	8.00	0.3150	75.0	117.0	8.00
R0038.1	–	8.10	0.3189	75.0	117.0	8.10
R0038.2	–	8.20	0.3228	75.0	117.0	8.20
R0038.3	–	8.30	0.3268	75.0	117.0	8.30
R00321/64	21/64	8.33	0.3281	75.0	117.0	8.33
R0038.4	–	8.40	0.3307	75.0	117.0	8.40
R003Q	Q	8.43	0.3320	75.0	117.0	8.43
R0038.5	–	8.50	0.3346	75.0	117.0	8.50
R0038.6	–	8.60	0.3386	81.0	125.0	8.60
R003R	R	8.61	0.3390	81.0	125.0	8.61
R0038.7	–	8.70	0.3425	81.0	125.0	8.70
R00311/32	11/32	8.73	0.3437	81.0	125.0	8.73
R0038.8	–	8.80	0.3465	81.0	125.0	8.80
R0038.9	–	8.90	0.3504	81.0	125.0	8.90
R0039.0	–	9.00	0.3543	81.0	125.0	9.00
R0039.1	–	9.10	0.3583	81.0	125.0	9.10
R00323/64	23/64	9.13	0.3594	81.0	125.0	9.13
R0039.2	–	9.20	0.3622	81.0	125.0	9.20
R0039.3	–	9.30	0.3661	81.0	125.0	9.30
R003U	U	9.35	0.3680	81.0	125.0	9.35
R0039.4	–	9.40	0.3701	81.0	125.0	9.40
R0039.5	–	9.50	0.3740	81.0	125.0	9.50
R0033/8	3/8	9.53	0.3750	87.0	133.0	9.53
R0039.6	–	9.60	0.3780	87.0	133.0	9.60
R0039.7	–	9.70	0.3819	87.0	133.0	9.70
R0039.8	–	9.80	0.3858	87.0	133.0	9.80
R003W	W	9.80	0.3860	87.0	133.0	9.80
R0039.9	–	9.90	0.3898	87.0	133.0	9.90
R00310.0	–	10.00	0.3937	87.0	133.0	10.00
R00310.2	–	10.20	0.4016	87.0	133.0	10.20
R00313/32	13/32	10.32	0.4063	87.0	133.0	10.32
R00310.5	–	10.50	0.4134	87.0	133.0	10.50
R00327/64	27/64	10.72	0.4219	94.0	142.0	10.72
R00311.0	–	11.00	0.4331	94.0	142.0	11.00
R0037/16	7/16	11.11	0.4375	94.0	142.0	11.11
R00311.5	–	11.50	0.4528	94.0	142.0	11.50
R00329/64	29/64	11.51	0.4531	94.0	142.0	11.51
R00315/32	15/32	11.91	0.4687	101.0	151.0	11.91
R00312.0	–	12.00	0.4724	101.0	151.0	12.00
R0031/2	1/2	12.70	0.5000	101.0	151.0	12.70
R00313.0	–	13.00	0.5118	101.0	151.0	13.00
R00314.0	–	14.00	0.5512	108.0	160.0	14.00



R023



Broca de metal duro extra corta, punta recubierta de TiN

Broca básica y versátil con ángulo de punta de 120° y geometría de punta dividida en cuatro facetas para reducir la fuerza de empuje. Tecnología CTW para mejorar la velocidad de taladrado. El recubrimiento TiN de la punta mejora el rendimiento y prolonga la vida útil de la herramienta. Adecuada para máquinas CNC y convencionales en el taladrado de una amplia gama de materiales.

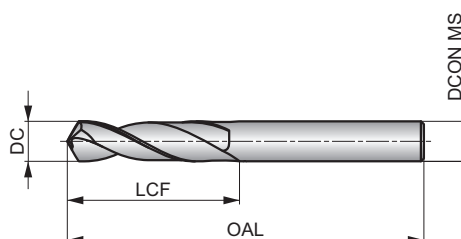

HM	DIN 6539	2.5xD
120°	TiN-Tip	
λ 20-35°	R	DC h7

Grupo de Material de la pieza adecuado y condiciones de velocidad de corte iniciales (m/min) y código de avance alfabético. Tablas con avance por revolución a partir de la pag. 10.

P1.1 ■ 99 T	P1.2 ■ 111 T	P1.3 ■ 115 T	P2.1 ■ 85 T	P2.2 ■ 75 T	P2.3 ■ 66 T	P3.1 ■ 66 T	P3.2 ■ 53 T	P3.3 ■ 45 T	P4.1 ■ 40 S	P4.2 ■ 34 S	P4.3 ■ 27 S	K1.1 ■ 75 U	K1.2 ■ 56 U
K1.3 ■ 42 U	K2.1 ■ 68 U	K2.2 ■ 55 U	K2.3 ■ 44 U	K3.1 ■ 60 U	K3.2 ■ 46 U	K3.3 ■ 37 U	K4.1 ■ 55 T	K4.2 ■ 42 T	K4.3 ■ 31 T	K4.4 ■ 26 T	K4.5 ■ 22 T	K5.1 ■ 63 U	K5.2 ■ 47 U
K5.3 ■ 37 U	N1.1 ■ 150 W	N1.2 ■ 113 W	N1.3 ■ 75 W	N2.1 ■ 129 W	N2.2 ■ 116 W	N2.3 ■ 84 W	N3.1 ■ 317 W	N3.2 ■ 190 W	N4.1 ■ 60 V	N4.2 ■ 100 V	H1.1 ■ 34 S	H2.1 ■ 20 S	H3.1 ■ 22 S

Producto	DC	DC	LCF	OAL	DCON MS
	(mm)	(inch)			
R0231.0	1.00	0.0394	6.0	26.0	1.00
R0231.1	1.10	0.0433	7.0	28.0	1.10
R0231.2	1.20	0.0472	8.0	30.0	1.20
R0231.3	1.30	0.0512	8.0	30.0	1.30
R0231.4	1.40	0.0551	9.0	32.0	1.40
R0231.5	1.50	0.0591	9.0	32.0	1.50
R0231.6	1.60	0.0630	10.0	34.0	1.60
R0231.7	1.70	0.0669	10.0	34.0	1.70
R0231.8	1.80	0.0709	11.0	36.0	1.80
R0231.9	1.90	0.0748	11.0	36.0	1.90
R0232.0	2.00	0.0787	12.0	38.0	2.00
R0232.1	2.10	0.0827	12.0	38.0	2.10
R0232.2	2.20	0.0866	13.0	40.0	2.20
R0232.3	2.30	0.0906	13.0	40.0	2.30
R0232.4	2.40	0.0945	14.0	43.0	2.40
R0232.5	2.50	0.0984	14.0	43.0	2.50
R0232.6	2.60	0.1024	14.0	43.0	2.60
R0232.7	2.70	0.1063	16.0	46.0	2.70
R0232.8	2.80	0.1102	16.0	46.0	2.80
R0232.9	2.90	0.1142	16.0	46.0	2.90
R0233.0	3.00	0.1181	16.0	46.0	3.00
R0233.1	3.10	0.1220	18.0	49.0	3.10
R0233.2	3.20	0.1260	18.0	49.0	3.20
R0233.3	3.30	0.1299	18.0	49.0	3.30
R0233.4	3.40	0.1339	20.0	52.0	3.40
R0233.5	3.50	0.1378	20.0	52.0	3.50
R0233.6	3.60	0.1417	20.0	52.0	3.60
R0233.7	3.70	0.1457	20.0	52.0	3.70

Producto	DC	DC	LCF	OAL	DCON MS
	(mm)	(inch)			
R0233.8	3.80	0.1496	22.0	55.0	3.80
R0233.9	3.90	0.1535	22.0	55.0	3.90
R0234.0	4.00	0.1575	22.0	55.0	4.00
R0234.1	4.10	0.1614	22.0	55.0	4.10
R0234.2	4.20	0.1654	22.0	55.0	4.20
R0234.3	4.30	0.1693	24.0	58.0	4.30
R0234.4	4.40	0.1732	24.0	58.0	4.40
R0234.5	4.50	0.1772	24.0	58.0	4.50
R0234.6	4.60	0.1811	24.0	58.0	4.60
R0234.7	4.70	0.1850	24.0	58.0	4.70
R0234.8	4.80	0.1890	26.0	62.0	4.80
R0234.9	4.90	0.1929	26.0	62.0	4.90
R0235.0	5.00	0.1969	26.0	62.0	5.00
R0235.1	5.10	0.2008	26.0	62.0	5.10
R0235.2	5.20	0.2047	26.0	62.0	5.20
R0235.3	5.30	0.2087	26.0	62.0	5.30
R0235.4	5.40	0.2126	28.0	66.0	5.40
R0235.5	5.50	0.2165	28.0	66.0	5.50
R0235.6	5.60	0.2205	28.0	66.0	5.60
R0235.7	5.70	0.2244	28.0	66.0	5.70
R0235.8	5.80	0.2283	28.0	66.0	5.80
R0235.9	5.90	0.2323	28.0	66.0	5.90
R0236.0	6.00	0.2362	28.0	66.0	6.00
R0236.1	6.10	0.2402	31.0	70.0	6.10
R0236.2	6.20	0.2441	31.0	70.0	6.20
R0236.3	6.30	0.2480	31.0	70.0	6.30
R0236.4	6.40	0.2520	31.0	70.0	6.40
R0236.5	6.50	0.2559	31.0	70.0	6.50



Producto	DC	DC	LCF	OAL	DCON MS
	(mm)	(inch)	(mm)	(mm)	(mm)
R0236.6	6.60	0.2598	31.0	70.0	6.60
R0236.7	6.70	0.2638	31.0	70.0	6.70
R0236.8	6.80	0.2677	34.0	74.0	6.80
R0236.9	6.90	0.2717	34.0	74.0	6.90
R0237.0	7.00	0.2756	34.0	74.0	7.00
R0237.1	7.10	0.2795	34.0	74.0	7.10
R0237.2	7.20	0.2835	34.0	74.0	7.20
R0237.3	7.30	0.2874	34.0	74.0	7.30
R0237.4	7.40	0.2913	34.0	74.0	7.40
R0237.5	7.50	0.2953	34.0	74.0	7.50
R0237.6	7.60	0.2992	37.0	79.0	7.60
R0237.7	7.70	0.3031	37.0	79.0	7.70
R0237.8	7.80	0.3071	37.0	79.0	7.80
R0237.9	7.90	0.3110	37.0	79.0	7.90
R0238.0	8.00	0.3150	37.0	79.0	8.00
R0238.1	8.10	0.3189	37.0	79.0	8.10
R0238.2	8.20	0.3228	37.0	79.0	8.20
R0238.3	8.30	0.3268	37.0	79.0	8.30
R0238.4	8.40	0.3307	37.0	79.0	8.40
R0238.5	8.50	0.3346	37.0	79.0	8.50

Producto	DC	DC	LCF	OAL	DCON MS
	(mm)	(inch)	(mm)	(mm)	(mm)
R0238.6	8.60	0.3386	40.0	84.0	8.60
R0238.7	8.70	0.3425	40.0	84.0	8.70
R0238.8	8.80	0.3465	40.0	84.0	8.80
R0238.9	8.90	0.3504	40.0	84.0	8.90
R0239.0	9.00	0.3543	40.0	84.0	9.00
R0239.1	9.10	0.3583	40.0	84.0	9.10
R0239.2	9.20	0.3622	40.0	84.0	9.20
R0239.3	9.30	0.3661	40.0	84.0	9.30
R0239.4	9.40	0.3701	40.0	84.0	9.40
R0239.5	9.50	0.3740	40.0	84.0	9.50
R0239.6	9.60	0.3780	43.0	89.0	9.60
R0239.7	9.70	0.3819	43.0	89.0	9.70
R0239.8	9.80	0.3858	43.0	89.0	9.80
R0239.9	9.90	0.3898	43.0	89.0	9.90
R02310.0	10.00	0.3937	43.0	89.0	10.00
R02310.2	10.20	0.4016	43.0	89.0	10.20
R02310.5	10.50	0.4134	43.0	89.0	10.50
R02311.0	11.00	0.4331	47.0	95.0	11.00
R02311.5	11.50	0.4528	47.0	95.0	11.50
R02312.0	12.00	0.4724	51.0	102.0	12.00



TABLA DE VELOCIDADES DE AVANCE DE TALADRADO

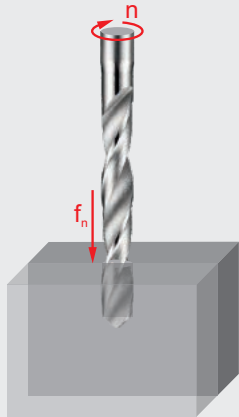

Avance por revolución (f_n en mm/rev)
Dependiendo de las condiciones de trabajo puede ser necesario ajustar estos valores $\pm 25\%$

Cómo utilizar esta tabla para encontrar el valor de avance por revolución (f_n):

1. Localice su código alfa en la página del producto (ejemplo: 60 T, «T» es el código alfa).
2. Localice en la fila superior de la tabla el diámetro más adecuado para su aplicación de corte.
3. Localice su código alfa en la columna de la izquierda de la tabla.
4. La intersección (celda) del diámetro y el código alfa es el avance por revolución (f_n).

		Ø DC (mm)																		
		0.15	0.50	1.00	2.00	3.00	4.00	5.00	6.00	8.00	10.00	12.00	15.00	16.00	20.00	25.00	30.00	40.00	50.00	100.00
Avances (mm/rev)	A	0.003	0.006	0.012	0.023	0.029	0.032	0.036	0.042	0.054	0.062	0.069	0.082	0.086	0.110	0.125	0.135	0.155	0.175	0.263
	B	0.004	0.007	0.014	0.028	0.037	0.041	0.046	0.053	0.067	0.080	0.090	0.103	0.108	0.135	0.153	0.165	0.188	0.208	0.312
	C	0.004	0.008	0.015	0.032	0.044	0.050	0.056	0.064	0.080	0.098	0.110	0.125	0.130	0.160	0.180	0.195	0.220	0.240	0.360
	D	0.004	0.008	0.016	0.038	0.053	0.060	0.068	0.078	0.098	0.119	0.130	0.149	0.155	0.188	0.210	0.228	0.253	0.275	0.413
	E	0.004	0.009	0.017	0.043	0.062	0.071	0.080	0.092	0.115	0.140	0.150	0.173	0.180	0.215	0.240	0.260	0.285	0.310	0.465
	F	0.005	0.009	0.018	0.050	0.073	0.084	0.095	0.109	0.138	0.165	0.178	0.202	0.210	0.248	0.275	0.295	0.320	0.343	0.515
	G	0.005	0.010	0.019	0.056	0.084	0.096	0.109	0.126	0.160	0.190	0.205	0.231	0.240	0.280	0.310	0.330	0.355	0.375	0.563
	H	0.005	0.010	0.020	0.066	0.102	0.116	0.130	0.150	0.190	0.228	0.243	0.271	0.280	0.320	0.355	0.375	0.398	0.418	0.627
	I	0.005	0.011	0.021	0.076	0.119	0.134	0.150	0.173	0.220	0.265	0.280	0.310	0.320	0.360	0.400	0.420	0.440	0.460	0.690
	J	0.006	0.012	0.024	0.084	0.135	0.152	0.170	0.197	0.250	0.298	0.315	0.349	0.360	0.405	0.445	0.465	0.485	0.503	0.755
	K	0.007	0.013	0.026	0.092	0.150	0.170	0.190	0.220	0.280	0.330	0.350	0.388	0.400	0.450	0.490	0.510	0.530	0.545	0.818
	L	0.007	0.014	0.028	0.101	0.165	0.186	0.208	0.240	0.305	0.360	0.385	0.419	0.430	0.485	0.525	0.545	0.568	0.588	0.882
	M	0.008	0.015	0.030	0.110	0.180	0.202	0.225	0.260	0.330	0.390	0.420	0.450	0.460	0.520	0.560	0.580	0.605	0.630	0.945
	N	0.008	0.016	0.032	0.119	0.195	0.218	0.242	0.280	0.355	0.420	0.455	0.481	0.490	0.555	0.595	0.615	0.642	0.672	1.008
	S	0.002	0.004	0.008	0.014	0.020	0.025	0.030	0.037	0.050	0.080	0.100	0.123	0.130	0.150	0.170	0.190	0.220	0.240	–
	T	0.004	0.008	0.015	0.028	0.040	0.050	0.060	0.070	0.090	0.110	0.130	0.160	0.170	0.190	0.210	0.230	0.260	0.275	–
	U	0.007	0.013	0.026	0.048	0.070	0.080	0.090	0.107	0.140	0.170	0.200	0.223	0.230	0.240	0.270	0.300	0.360	0.375	–
	V	0.010	0.019	0.038	0.069	0.100	0.115	0.130	0.153	0.200	0.250	0.280	0.310	0.320	0.340	0.400	0.440	0.510	0.530	–
	W	0.012	0.025	0.049	0.089	0.130	0.150	0.170	0.200	0.260	0.330	0.380	0.418	0.430	0.450	0.470	0.490	0.520	0.540	–
	X	0.014	0.028	0.056	0.103	0.150	0.180	0.210	0.250	0.330	0.420	0.480	0.533	0.550	0.580	–	–	–	–	–
Y	0.017	0.034	0.068	0.124	0.180	0.220	0.260	0.317	0.430	0.550	0.700	0.700	0.700	0.740	–	–	–	–	–	
Z	0.024	0.047	0.094	0.172	0.250	0.325	0.400	0.533	0.800	1.000	1.100	1.175	1.200	1.200	–	–	–	–	–	



E397
E398

MACHOS MULTIAPLICACIÓN DE ALTA PRODUCTIVIDAD (DIN)

INTRODUCCIÓN



Presentamos los machos de roscar Dormer E397 y E398, el resumen de la versatilidad y el rendimiento. Diseñados para una profundidad de roscado de 2.5xD con una geometría específica para mecanizar materiales de resistencia media a alta, evitando al mismo tiempo roscas sobredimensionadas en los materiales más blandos. El tratamiento modificado del filo garantiza una larga vida útil de la herramienta con resultados consistentes, y el perfil de estrías de 3 radios proporciona precisión y seguridad en el proceso. Con un recubrimiento de TiCN para mayor resistencia al desgaste y un sustrato pulvimetalúrgico único, los machos de roscar Dormer E397 y E398 ofrecen un alto rendimiento sin concesiones.



 **DORMER**



E397(M)

- Sólo para agujeros pasantes
- Norma DIN 371 / 376
- Rosca Métrica: M3 – M30



E397(MF)

- Sólo para agujeros pasantes
- Norma DIN 374
- Rosca Métrica Fina: M8x1 – M20x1.5



E397(UNC)

- Sólo para agujeros pasantes
- Norma DIN 2184-1
- Rosca UNC: No. 8-32 – 1/2" - 13



E397(UNF)

- Sólo para orificios pasantes
- Norma DIN 2184-1
- Rosca UNF: 1/4"-28 – 1/2"-20



HERRAMIENTAS DE ROSCADO

CARACTERÍSTICAS Y VENTAJAS

Su geometría evita el bloqueo en materiales de resistencia media y alta, y las roscas sobredimensionadas en materiales blandos.



EXCELENTE EN ACEROS

y versátil en muchos otros materiales.

El redondeamiento modificado del filo aumenta su estabilidad y reduce el riesgo de astillado.



MAYOR VIDA ÚTIL DE LA HERRAMIENTA

y consistencia a largo plazo.

el perfil de 3 radios proporciona máximo control en el corte y asegura una evacuación de viruta adecuada.



ALTA FIABILIDAD DEL PROCESO

asegurada mediante la prevención de la acumulación de viruta.

El revestimiento TiCN garantiza una alta resistencia al desgaste combinada con un bajo coeficiente de fricción.



PROTECCIÓN CONTRA LA SOLDADURA EN FRÍO

durante toda la vida útil.

El sustrato HSS-E PM pulvimetalúrgico proporciona una excelente combinación de tenacidad y dureza del filo.



ALTO RENDIMIENTO

sin comprometer la vida útil de la herramienta.



DIN/ANSI



¡También hay disponibles machos norma DIN/ANSI!



JIS



¡También hay disponibles machos norma JIS!



E398(M)

- Principalmente para agujeros ciegos
- Norma DIN 371 / 376
- Rosca Métrica: M3 – M30



E398(MF)

- Principalmente para agujeros ciegos
- Norma DIN 374
- Rosca Métrica Fina: M8x1 – M20x1.5



E398(UNC)

- Principalmente para agujeros ciegos
- Norma DIN 2184-1
- Rosca UNC: No. 8-32 – 1/2" - 13



E398(UNF)

- Principalmente para agujeros ciegos
- Norma DIN 2184-1
- Rosca UNF: 1/4" - 28 – 1/2" - 20



E397
E398

MACHOS MULTIAPLICACIÓN DE ALTA PRODUCTIVIDAD (DIN)

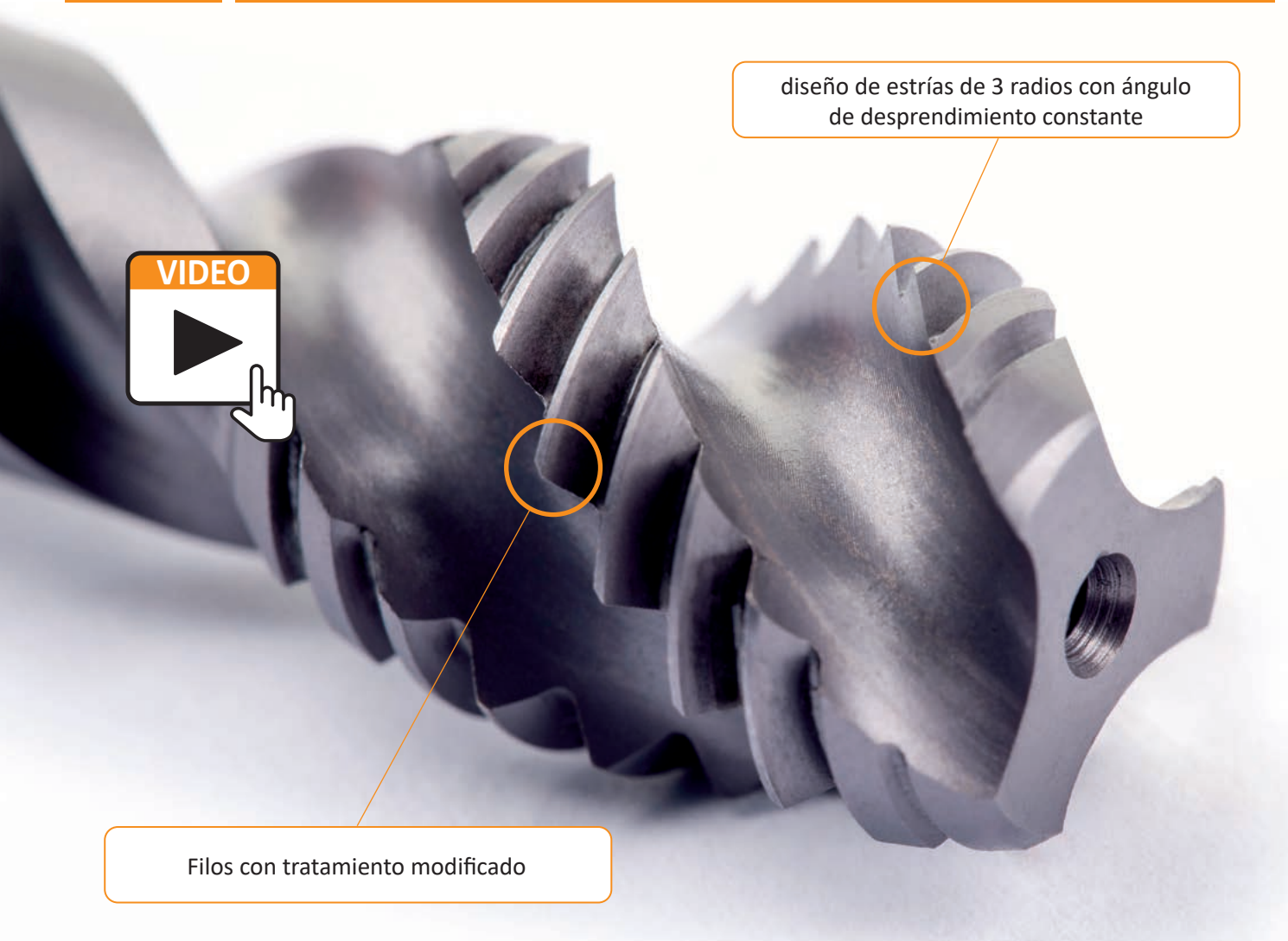

diseño de estrías de 3 radios con ángulo de desprendimiento constante

VIDEO



Filos con tratamiento modificado

HISTORIA DE ÉXITO – E398

Segmento: Ingeniería general (República Checa)
Componente: Piezas del circuito hidráulico
Material: 42CrMo4 / EN 10083 (Acero aleado, 250 HB)
Refrigerante: Sí, externa, emulsión de aceite soluble en agua (~ 8%)
Aplicación: Roscado de agujero ciego de M6 a 2.5xD, agujero pretaladrado de Ø 5.1 mm de 21 mm de profundidad y realizado con broca de metal duro. Roscado en CNC Tajmac MCFV 1060 utilizando un portamachos Tapmatic SynchroFlex SFT II75.

Resultados anteriores: Graves problemas causados por acumulación de viruta, se alcanzó una media de 1000 roscas con los machos actuales. El mejor macho alternativo de la competencia mejoró la vida útil de la herramienta hasta 1353 roscas de media, pero los problemas de acumulación de viruta siguieron siendo frecuentes.

Resultado con E398: Nuestro nuevo diseño de macho de roscar alcanzó una media de 1.645 roscas (+22%) con un mayor nivel de seguridad del proceso y un anidado limitado, lo que se traduce en una mejora de la productividad.

Solución Dormer Pramet:

E398M6

Datos de mecanizado:

v_c	td
15	15

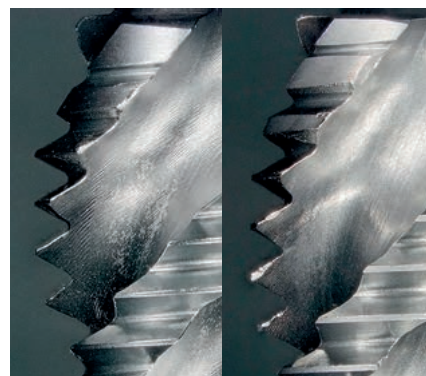

DORMER después de 944 roscas COMPETIDOR después de 944 roscas

WMG P3.2



Forma de la rosca (THFT)		M	MF	UNC	UNF	M	MF	UNC	UNF
Grupo básico estándar (BSG)		DIN 371/376	DIN 374	DIN 2184-1	DIN 2184-1	DIN 371/376	DIN 374	DIN 2184-1	DIN 2184-1
Clase de tolerancia de la rosca (TCTR)		6HX	6HX	2BX	2BX	6HX	6HX	2BX	2BX
Aplicación de roscado									
Longitud Útil (ULDR)		2.5×D	2.5×D	2.5×D	2.5×D	2.5×D	2.5×D	2.5×D	2.5×D
Código de Material (BMC)		HSS-E PM	HSS-E PM	HSS-E PM	HSS-E PM	HSS-E PM	HSS-E PM	HSS-E PM	HSS-E PM
Chafilán de entrada		B 3.5-5	B 3.5-5	B 3.5-5	B 3.5-5	C 2-3	C 2-3	C 2-3	C 2-3
Geometría del canal (FDC)									
Ángulo de la hélice del canal (FHA)						λ 48°	λ 48°	λ 48°	λ 48°
Mano (dirección de corte)									
Recubrimiento									
Código de Familia de Producto		E397(M)	E397(MF)	E397(UNC)	E397(UNF)	E398(M)	E398(MF)	E398(UNC)	E398(UNF)
Gama de diámetros de corte PSF		M3 – M30	M8 – M20	No.8 – 1/2"	1/4 – 1/2"	M3 – M30	M8 – M20	No.8 – 1/2"	1/4 – 1/2"
P	P1	■	■	■	■	■	■	■	■
	P2	■	■	■	■	■	■	■	■
	P3	■	■	■	■	■	■	■	■
	P4	■	■	■	■	■	■	■	■
M	M1	■	■	■	■	■	■	■	■
	M2	■	■	■	■	■	■	■	■
	M3	■	■	■	■	■	■	■	■
	M4	☑	☑	☑	☑	☑	☑	☑	☑
K	K1	☑	☑	☑	☑				
	K2	☑	☑	☑	☑				
	K3	☑	☑	☑	☑				
	K4	☑	☑	☑	☑				
	K5								
N	N1	☑	☑	☑	☑	☑	☑	☑	☑
	N2	☑	☑	☑	☑	☑	☑	☑	☑
	N3	☑	☑	☑	☑	☑	☑	☑	☑
	N4	☑	☑	☑	☑				
	N5								
S	S1								
	S2								
	S3								
	S4								
H	H1								
	H2								
	H3								
	H4								



E397(M)



Macho de roscar HSS-E-PM, con entrada en hélice, rosca métrica, norma DIN y recubrimiento TiCN

Macho de roscar para aplicaciones de alta productividad con entrada en hélice sólo para agujeros pasantes de 2,5xD. Adecuado para el mecanizado de una gran variedad de materiales. Sustrato único de HSS-E-PM con recubrimiento de TiCN para ofrecer una mayor resistencia a la abrasión, mayores velocidades de corte, mejorar la calidad de la rosca, reducir los tiempos de ciclo y alargar la vida útil de la herramienta.

	DIN 371/376	6HX
	2.5xD	HSS-E PM
B 3.5-5		

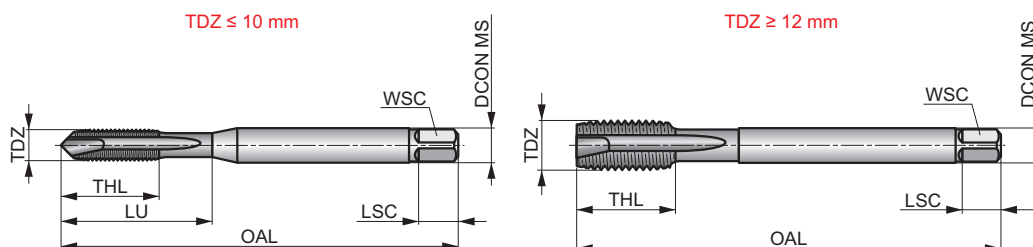

Grupo de Material de la pieza adecuado y condiciones de corte iniciales (m/min).

P1.1 ■ 37	P1.2 ■ 42	P1.3 ■ 44	P2.1 ■ 33	P2.2 ■ 28	P2.3 ■ 25	P3.1 ■ 20	P3.2 ■ 16	P3.3 ▣ 13	P4.1 ■ 12	P4.2 ▣ 9	M1.1 ■ 15	M1.2 ■ 12	M2.1 ■ 13
M2.2 ■ 11	M3.1 ■ 9	M3.2 ■ 7	M3.3 ▣ 6	M4.1 ▣ 4	K1.1 ▣ 20	K1.2 ▣ 15	K1.3 ▣ 11	K2.1 ▣ 29	K2.2 ▣ 23	K3.1 ▣ 25	K3.2 ▣ 19	K4.1 ▣ 23	K4.2 ▣ 17
N1.3 ▣ 12	N2.1 ▣ 37	N2.2 ▣ 34	N2.3 ▣ 24	N3.1 ▣ 60	N3.2 ▣ 36	N4.1 ▣ 26							

Producto	TDZ	TP	OAL	THL	DCON MS	WSC	LSC	NOF	PHD	LU
		(mm)	(mm)	(mm)	(mm)	(mm)	(mm)		(mm)	(mm)
E397M3	3	0.50	56.0	9	3.50	2.70	6	3	2.50	18.00
E397M4	4	0.70	63.0	12	4.50	3.40	6	3	3.30	21.00
E397M5	5	0.80	70.0	13	6.00	4.90	8	3	4.20	25.00
E397M6	6	1.00	80.0	15	6.00	4.90	8	3	5.00	30.00
E397M8	8	1.25	90.0	18	8.00	6.20	9	3	6.80	35.00
E397M10	10	1.50	100.0	20	10.00	8.00	11	3	8.50	39.00
E397M12	12	1.75	110.0	23	9.00	7.00	10	4	10.30	–
E397M14	14	2.00	110.0	25	11.00	9.00	12	4	12.00	–
E397M16	16	2.00	110.0	25	12.00	9.00	12	4	14.00	–
E397M18	18	2.50	125.0	30	14.00	11.00	14	4	15.50	–
E397M20	20	2.50	140.0	30	16.00	12.00	15	4	17.50	–
E397M22	22	2.50	140.0	34	18.00	14.50	17	4	19.50	–
E397M24	24	3.00	160.0	38	18.00	14.50	17	4	21.00	–
E397M27	27	3.00	160.0	38	20.00	16.00	19	4	24.00	–
E397M30	30	3.50	180.0	45	22.00	18.00	21	4	26.50	–



E397(MF)



Macho de roscar HSS-E-PM, con entrada en hélice, rosca métrica fina, norma DIN y recubrimiento TiCN

Macho de roscar para aplicaciones de alta productividad con entrada en hélice sólo para agujeros pasantes de 2,5xD. Adecuado para el mecanizado de una gran variedad de materiales. Sustrato único de HSS-E-PM con recubrimiento de TiCN para ofrecer una mayor resistencia a la abrasión, mayores velocidades de corte, mejorar la calidad de la rosca, reducir los tiempos de ciclo y alargar la vida útil de la herramienta.

	DIN 374	6HX
	2.5xD	HSS-E PM
B 3.5-5		

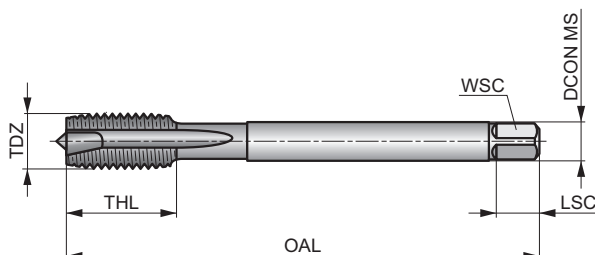

Grupo de Material de la pieza adecuado y condiciones de corte iniciales (m/min).

P1.1 ■ 37	P1.2 ■ 42	P1.3 ■ 44	P2.1 ■ 33	P2.2 ■ 28	P2.3 ■ 25	P3.1 ■ 20	P3.2 ■ 16	P3.3 ■ 13	P4.1 ■ 12	P4.2 ■ 9	M1.1 ■ 15	M1.2 ■ 12	M2.1 ■ 13
M2.2 ■ 11	M3.1 ■ 9	M3.2 ■ 7	M3.3 ■ 6	M4.1 ■ 4	K1.1 ■ 20	K1.2 ■ 15	K1.3 ■ 11	K2.1 ■ 29	K2.2 ■ 23	K3.1 ■ 25	K3.2 ■ 19	K4.1 ■ 23	K4.2 ■ 17
N1.3 ■ 12	N2.1 ■ 37	N2.2 ■ 34	N2.3 ■ 24	N3.1 ■ 60	N3.2 ■ 36	N4.1 ■ 26							

Producto	TDZ	TP	OAL	THL	DCON MS	WSC	LSC	NOF	PHD
		(mm)	(mm)	(mm)	(mm)	(mm)	(mm)		(mm)
E397M8X1.0	8	1.00	90.0	18	6.00	4.90	8	3	7.00
E397M10X1.0	10	1.00	90.0	18	7.00	5.50	8	3	9.00
E397M10X1.25	10	1.25	100.0	20	7.00	5.50	8	3	8.80
E397M12X1.0	12	1.00	100.0	21	9.00	7.00	10	4	11.00
E397M12X1.25	12	1.25	100.0	21	9.00	7.00	10	4	10.80
E397M12X1.5	12	1.50	100.0	21	9.00	7.00	10	4	10.50
E397M14X1.5	14	1.50	100.0	21	11.00	9.00	12	4	12.50
E397M16X1.5	16	1.50	100.0	21	12.00	9.00	12	4	14.50
E397M20X1.5	20	1.50	125.0	24	16.00	12.00	15	4	18.50



E397(UNC)



Macho de roscar HSS-E-PM, con entrada en hélice, rosca UNC, norma DIN y recubrimiento TiCN

Macho de roscar para aplicaciones de alta productividad con entrada en hélice sólo para agujeros pasantes de 2,5xD. Adecuado para el mecanizado de una gran variedad de materiales. Sustrato único de HSS-E-PM con recubrimiento de TiCN para ofrecer una mayor resistencia a la abrasión, mayores velocidades de corte, mejorar la calidad de la rosca, reducir los tiempos de ciclo y alargar la vida útil de la herramienta.

	DIN 2184-1	2BX
	2.5xD	HSS-E PM
B 3.5-5		

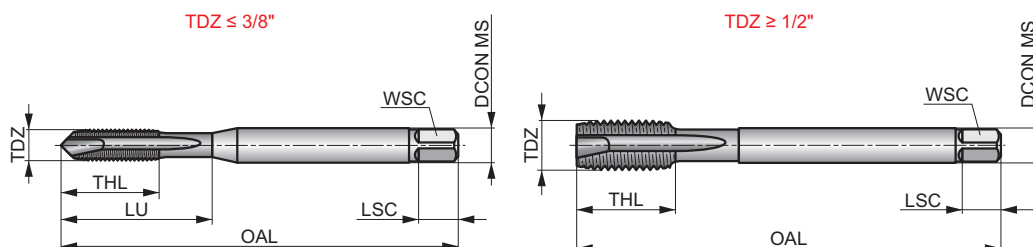

Grupo de Material de la pieza adecuado y condiciones de corte iniciales (m/min).

P1.1 ■ 37	P1.2 ■ 42	P1.3 ■ 44	P2.1 ■ 33	P2.2 ■ 28	P2.3 ■ 25	P3.1 ■ 20	P3.2 ■ 16	P3.3 ▣ 13	P4.1 ■ 12	P4.2 ▣ 9	M1.1 ■ 15	M1.2 ■ 12	M2.1 ■ 13
M2.2 ■ 11	M3.1 ■ 9	M3.2 ■ 7	M3.3 ▣ 6	M4.1 ▣ 4	K1.1 ▣ 20	K1.2 ▣ 15	K1.3 ▣ 11	K2.1 ▣ 29	K2.2 ▣ 23	K3.1 ▣ 25	K3.2 ▣ 19	K4.1 ▣ 23	K4.2 ▣ 17
N1.3 ▣ 12	N2.1 ▣ 37	N2.2 ▣ 34	N2.3 ▣ 24	N3.1 ▣ 60	N3.2 ▣ 36	N4.1 ▣ 26							

Producto	TDZ	TPI	TD	OAL	THL	DCON MS	WSC	LSC	NOF	PHD	LU
			(mm)	(mm)	(mm)	(mm)	(mm)	(mm)		(mm)	(mm)
E397UNC8X32	8	32	4.17	63.0	12	4.50	3.40	6	3	3.50	21.00
E397UNC10X24	10	24	4.83	70.0	13	6.00	4.90	8	3	3.90	25.00
E397UNC1/4	1/4	20	6.35	80.0	15	7.00	5.50	8	3	5.10	30.00
E397UNC5/16	5/16	18	7.94	90.0	18	8.00	6.20	9	3	6.60	35.00
E397UNC3/8	3/8	16	9.53	100.0	20	10.00	8.00	11	3	8.00	39.00
E397UNC1/2	1/2	13	12.70	110.0	23	9.00	7.00	10	4	10.80	-



E397(UNF)



Macho de roscar HSS-E-PM, con entrada en hélice, rosca UNF, norma DIN y recubrimiento TiCN

Macho de roscar para aplicaciones de alta productividad con entrada en hélice sólo para agujeros pasantes de 2,5xD. Adecuado para el mecanizado de una gran variedad de materiales. Sustrato único de HSS-E-PM con recubrimiento de TiCN para ofrecer una mayor resistencia a la abrasión, mayores velocidades de corte, mejorar la calidad de la rosca, reducir los tiempos de ciclo y alargar la vida útil de la herramienta.

	DIN 2184-1	2BX
	2.5xD	HSS-E-PM
B 3.5-5		

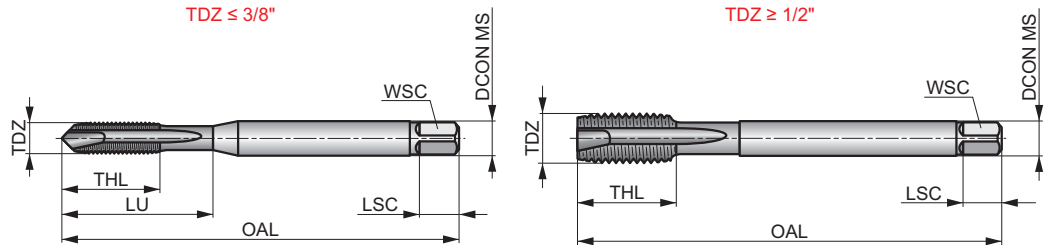

Grupo de Material de la pieza adecuado y condiciones de corte iniciales (m/min).

P1.1 ■ 37	P1.2 ■ 42	P1.3 ■ 44	P2.1 ■ 33	P2.2 ■ 28	P2.3 ■ 25	P3.1 ■ 20	P3.2 ■ 16	P3.3 ▣ 13	P4.1 ■ 12	P4.2 ▣ 9	M1.1 ■ 15	M1.2 ■ 12	M2.1 ■ 13
M2.2 ■ 11	M3.1 ■ 9	M3.2 ■ 7	M3.3 ▣ 6	M4.1 ▣ 4	K1.1 ▣ 20	K1.2 ▣ 15	K1.3 ▣ 11	K2.1 ▣ 29	K2.2 ▣ 23	K3.1 ▣ 25	K3.2 ▣ 19	K4.1 ▣ 23	K4.2 ▣ 17
N1.3 ▣ 12	N2.1 ▣ 37	N2.2 ▣ 34	N2.3 ▣ 24	N3.1 ▣ 60	N3.2 ▣ 36	N4.1 ▣ 26							

Producto	TDZ	TPI	TD	OAL	THL	DCON MS	WSC	LSC	NOF	PHD	LU
			(mm)	(mm)	(mm)	(mm)	(mm)	(mm)		(mm)	(mm)
E397UNF1/4	1/4	28	6.35	80.0	15	7.00	5.50	8	3	5.50	30.00
E397UNF5/16	5/16	24	7.94	90.0	18	8.00	6.20	9	3	6.90	35.00
E397UNF3/8	3/8	24	9.53	100.0	20	10.00	8.00	11	3	8.50	39.00
E397UNF1/2	1/2	20	12.70	110.0	23	9.00	7.00	10	4	11.50	-



E398(M)



Macho de roscar helicoidal HSS-E-PM, rosca métrica, norma DIN y recubrimiento TiCN

Macho de máquina helicoidal para aplicaciones de alta productividad para agujeros ciegos de 2,5xD. Adecuado para una gran variedad de materiales. Sustrato de HSS-E-PM con recubrimiento único de TiCN para ofrecer una resistencia superior a la abrasión, mayores velocidades de corte, mejorar la calidad de la rosca, reducir los tiempos de ciclo y alargar la vida útil de la herramienta. Recomendado para portamachos

	DIN 371/376	6HX
	2.5xD	HSS-E PM
		λ 48°

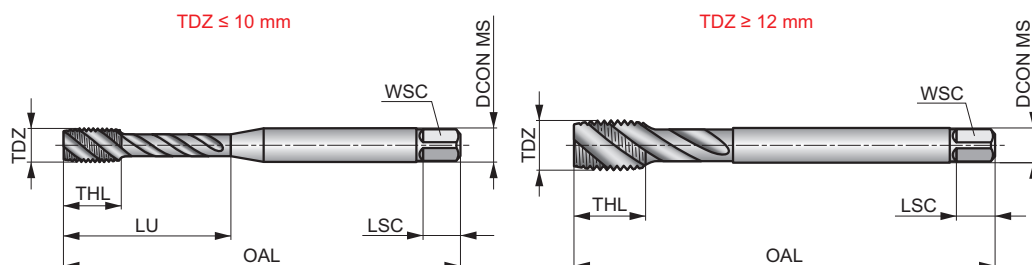

Grupo de Material de la pieza adecuado y condiciones de corte iniciales (m/min).

P1.1 ■ 35	P1.2 ■ 40	P1.3 ■ 42	P2.1 ■ 31	P2.2 ■ 27	P2.3 ■ 24	P3.1 ■ 19	P3.2 ■ 15	P3.3 ■ 12	P4.1 ■ 11	P4.2 ■ 9	M1.1 ■ 14	M1.2 ■ 11	M2.1 ■ 12
M2.2 ■ 10	M3.1 ■ 9	M3.2 ■ 7	M3.3 ■ 6	M4.1 ■ 4	N1.3 ■ 11	N2.1 ■ 35	N2.2 ■ 32	N2.3 ■ 23	N3.1 ■ 60				

Producto	TDZ	TP	OAL	THL	DCON MS	WSC	LSC	NOF	PHD	LU
		(mm)	(mm)	(mm)	(mm)	(mm)	(mm)		(mm)	(mm)
E398M3	3	0.50	56.0	6	3.50	2.70	6	3	2.50	18.00
E398M4	4	0.70	63.0	7	4.50	3.40	6	3	3.30	21.00
E398M5	5	0.80	70.0	8	6.00	4.90	8	3	4.20	25.00
E398M6	6	1.00	80.0	10	6.00	4.90	8	3	5.00	31.00
E398M8	8	1.25	90.0	12	8.00	6.20	9	3	6.80	35.00
E398M10	10	1.50	100.0	15	10.00	8.00	11	3	8.50	39.00
E398M12	12	1.75	110.0	16	9.00	7.00	10	3	10.30	–
E398M14	14	2.00	110.0	20	11.00	9.00	12	3	12.00	–
E398M16	16	2.00	110.0	20	12.00	9.00	12	4	14.00	–
E398M18	18	2.50	125.0	25	14.00	11.00	14	4	15.50	–
E398M20	20	2.50	140.0	25	16.00	12.00	15	4	17.50	–
E398M22	22	2.50	140.0	25	18.00	14.50	17	4	19.50	–
E398M24	24	3.00	160.0	30	18.00	14.50	17	4	21.00	–
E398M27	27	3.00	160.0	30	20.00	16.00	19	4	24.00	–
E398M30	30	3.50	180.0	36	22.00	18.00	21	4	26.50	–



E398(MF)



Macho de rosca helicoidal HSS-E-PM, rosca métrica fina, norma DIN y recubrimiento TiCN

Macho de máquina helicoidal para aplicaciones de alta productividad para agujeros ciegos de 2,5xD. Adecuado para una gran variedad de materiales. Sustrato de HSS-E-PM con recubrimiento único de TiCN para ofrecer una resistencia superior a la abrasión, mayores velocidades de corte, mejorar la calidad de la rosca, reducir los tiempos de ciclo y alargar la vida útil de la herramienta. Recomendado para portamachos

	DIN 374	6HX
	2.5xD	HSS-E PM
C 2-3		λ 48°

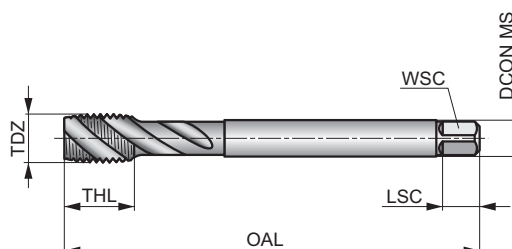

Grupo de Material de la pieza adecuado y condiciones de corte iniciales (m/min).

P1.1 ■ 35	P1.2 ■ 40	P1.3 ■ 42	P2.1 ■ 31	P2.2 ■ 27	P2.3 ■ 24	P3.1 ■ 19	P3.2 ■ 15	P3.3 ■ 12	P4.1 ■ 11	P4.2 ■ 9	M1.1 ■ 14	M1.2 ■ 11	M2.1 ■ 12
M2.2 ■ 10	M3.1 ■ 9	M3.2 ■ 7	M3.3 ■ 6	M4.1 ■ 4	N1.3 ■ 11	N2.1 ■ 35	N2.2 ■ 32	N2.3 ■ 23	N3.1 ■ 160				

Producto	TDZ	TP	OAL	THL	DCON MS	WSC	LSC	NOF	PHD
		(mm)	(mm)	(mm)	(mm)	(mm)	(mm)		(mm)
E398M8X1.0	8	1.00	90.0	13	6.00	4.90	8	3	7.00
E398M10X1.0	10	1.00	90.0	13	7.00	5.50	8	3	9.00
E398M10X1.25	10	1.25	100.0	15	7.00	5.50	8	3	8.80
E398M12X1.0	12	1.00	100.0	15	9.00	7.00	10	3	11.00
E398M12X1.25	12	1.25	100.0	15	9.00	7.00	10	3	10.80
E398M12X1.5	12	1.50	100.0	15	9.00	7.00	10	3	10.50
E398M14X1.5	14	1.50	100.0	15	11.00	9.00	12	3	12.50
E398M16X1.5	16	1.50	100.0	15	12.00	9.00	12	4	14.50
E398M20X1.5	20	1.50	125.0	17	16.00	12.00	15	4	18.50



E398(UNC)

DORMER

Macho de rosca helicoidal HSS-E-PM, rosca UNC, norma DIN y recubrimiento TiCN

Macho de máquina helicoidal para aplicaciones de alta productividad para agujeros ciegos de 2,5xD. Adecuado para una gran variedad de materiales. Sustrato de HSS-E-PM con recubrimiento único de TiCN para ofrecer una resistencia superior a la abrasión, mayores velocidades de corte, mejorar la calidad de la rosca, reducir los tiempos de ciclo y alargar la vida útil de la herramienta. Recomendado para portamachos



	DIN 2184-1	2BX
	2.5xD	HSS-E PM
		λ 48°

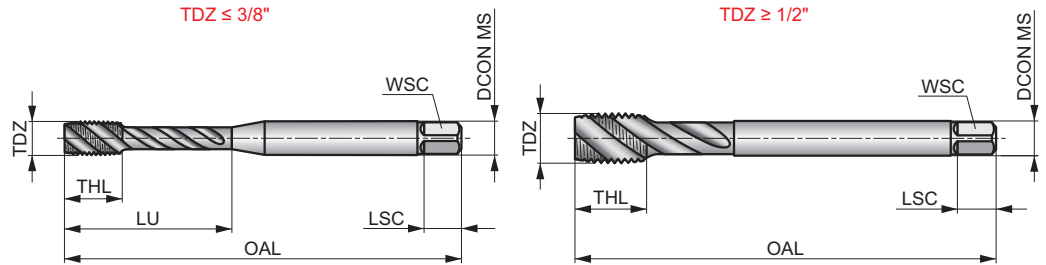

Grupo de Material de la pieza adecuado y condiciones de corte iniciales (m/min).

P1.1 ■ 35	P1.2 ■ 40	P1.3 ■ 42	P2.1 ■ 31	P2.2 ■ 27	P2.3 ■ 24	P3.1 ■ 19	P3.2 ■ 15	P3.3 ■ 12	P4.1 ■ 11	P4.2 ■ 9	M1.1 ■ 14	M1.2 ■ 11	M2.1 ■ 12
M2.2 ■ 10	M3.1 ■ 9	M3.2 ■ 7	M3.3 ■ 6	M4.1 ■ 4	N1.3 ■ 11	N2.1 ■ 35	N2.2 ■ 32	N2.3 ■ 23	N3.1 ■ 60				

Producto	TDZ	TPI	TD	OAL	THL	DCON MS	WSC	LSC	NOF	PHD	LU
			(mm)	(mm)	(mm)	(mm)	(mm)	(mm)		(mm)	(mm)
E398UNC8X32	8	32	4.17	63.0	7	4.50	3.40	6	3	3.50	21.00
E398UNC10X24	10	24	4.83	70.0	8	6.00	4.90	8	3	3.90	25.00
E398UNC1/4	1/4	20	6.35	80.0	10	7.00	5.50	8	3	5.10	30.00
E398UNC5/16	5/16	18	7.94	90.0	12	8.00	6.20	9	3	6.60	35.00
E398UNC3/8	3/8	16	9.53	100.0	15	10.00	8.00	11	3	8.00	39.00
E398UNC1/2	1/2	13	12.70	110.0	18	9.00	7.00	10	3	10.80	-



E398(UNF)



Macho de roscar helicoidal HSS-E-PM, rosca UNF, norma DIN y recubrimiento TiCN

Macho de máquina helicoidal para aplicaciones de alta productividad para agujeros ciegos de 2,5xD. Adecuado para una gran variedad de materiales. Sustrato de HSS-E-PM con recubrimiento único de TiCN para ofrecer una resistencia superior a la abrasión, mayores velocidades de corte, mejorar la calidad de la rosca, reducir los tiempos de ciclo y alargar la vida útil de la herramienta. Recomendado para portamachos

	DIN 2184-1	2BX
	2.5xD	HSS-E PM
C 2-3		λ 48°

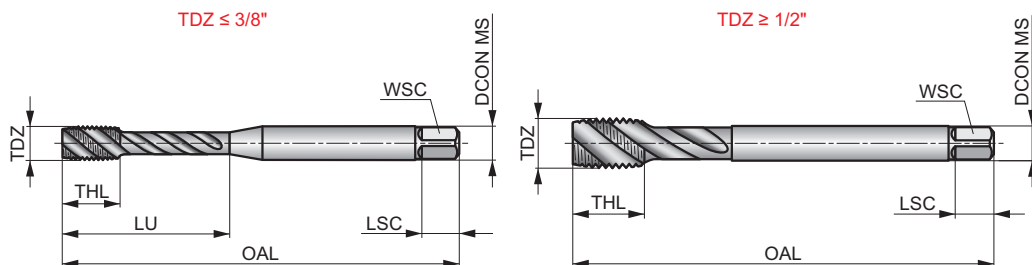

Grupo de Material de la pieza adecuado y condiciones de corte iniciales (m/min).

P1.1 ■ 35	P1.2 ■ 40	P1.3 ■ 42	P2.1 ■ 31	P2.2 ■ 27	P2.3 ■ 24	P3.1 ■ 19	P3.2 ■ 15	P3.3 ■ 12	P4.1 ■ 11	P4.2 ■ 9	M1.1 ■ 14	M1.2 ■ 11	M2.1 ■ 12
M2.2 ■ 10	M3.1 ■ 9	M3.2 ■ 7	M3.3 ■ 6	M4.1 ■ 4	N1.3 ■ 11	N2.1 ■ 35	N2.2 ■ 32	N2.3 ■ 23	N3.1 ■ 160				

Producto	TDZ	TPI	TD	OAL	THL	DCON MS	WSC	LSC	NOF	PHD	LU
			(mm)	(mm)	(mm)	(mm)	(mm)	(mm)		(mm)	(mm)
E398UNF1/4	1/4	28	6.35	80.0	10	7.00	5.50	8	3	5.50	30.00
E398UNF5/16	5/16	24	7.94	90.0	12	8.00	6.20	9	3	6.90	35.00
E398UNF3/8	3/8	24	9.53	100.0	15	10.00	8.00	11	3	8.50	39.00
E398UNF1/2	1/2	20	12.70	110.0	18	9.00	7.00	10	3	11.50	-



T8415

CALIDAD PVD VERSÁTIL PARA TORNEADO

INTRODUCCIÓN



Presentamos la calidad Pramet T8415, nuestra calidad PVD para un torneado de vanguardia. Versátil en aceros, aceros inoxidable y superaleaciones termorresistentes (HRSA), una capa superior de TiBN minimiza la fricción y optimiza el rendimiento en cortes ligeros en muchos tipos de materiales. Con una amplia gama de rompevirutas en plaquetas ISO positivas y negativas, la T8415 redefine el rendimiento y la eficacia del torneado.

 PRAMET



ÁMBITO DE APLICACIÓN DE LAS CALIDADES PVD





CARACTERÍSTICAS Y VENTAJAS

Recubrimiento PVD multicapa de nueva generación unido a metal duro de grado submicrónico de alta gama.



USO VERSÁTIL

para el mecanizado de una amplia gama de piezas.

La exclusiva capa superior deslizante de TiBN reduce el filo de aportación



MAYOR SEGURIDAD

en velocidades de corte medias y altas con refrigerante.

Capa gruesa de TiN con baja tensión de compresión residual.



LARGA VIDA ÚTIL DE LA HERRAMIENTA

incluso en condiciones de corte adversas.

Capa dura de AlTiN con composición de nuevo desarrollo



ALTA RESISTENCIA AL DESGASTE

contra el desgaste abrasivo y térmico.

La limpieza iónica de alta tecnología mejora la adherencia del revestimiento al sustrato.



REPETIBILIDAD DEL PROCESO

y estabilidad a largo plazo de la vida útil de la herramienta.

Exclusiva capa deslizante de TiBN

Capa gruesa de TiN

Capa dura de AlTiN

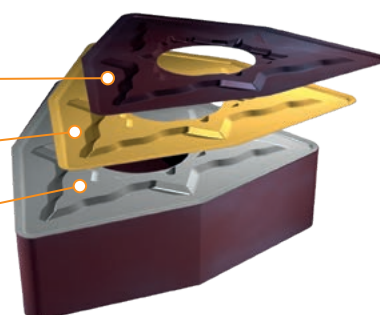

INFORMACIÓN TÉCNICA

Código de calidad	Área de aplicación	Aplicación	Avance	Velocidad de corte	Resistencia en condiciones de trabajo adversas	Recubrimiento	Color	Sustrato	Ventajas del refrigerante
T8415	P05 – P20	■				PVD		submicron H	++
	M05 – M20	■							
	K05 – K25	■							
	N05 – N25	■							
	S05 – S15	■							
	H05 – H15	■							

Descripción de la calidad

Una calidad versátil para torneado y de alto rendimiento destinada principalmente al mecanizado de acero, pero también adecuada para aceros inoxidables y superaleaciones termorresistentes (HRSA), posiblemente aplicable a aceros endurecidos. Es adecuada para el mecanizado a una amplia gama de velocidades de corte, avances de ligeros a medios y en buenas condiciones de corte, preferiblemente con refrigerante.

**T8415****CALIDAD PVD VERSÁTIL PARA TORNEADO****HISTORIAS DE ÉXITO – T8415**

Segmento: Subcontratista de piezas de automóvil (India)
Componente: Eje intermedio delgado
Material: EN8 / C40 / 1.0511 (Acero al carbono, 220 HB)
Refrigerante: Sí, emulsión de aceite soluble en agua – Taladrina (8%)
Aplicación: Diámetro exterior torneado semiacabado
Resultados anteriores: Con la plaquita de la competencia, el cliente tenía una vida útil estable de la herramienta con 160 piezas por filo, lo que era satisfactorio en ese momento.

Resultados con la T8415: Un filo de corte de la plaquita Pramet tiene un 120% de vida útil, pero con un avance aún mayor, ilo que aumentó la productividad hasta un 125%!

Solución Dormer Pramet:

DNMG 150608E-SM:T8415

Datos de mecanizado:

v_c	f_n	a_p
250	0.25	0.5

**WMG P2.2**

Segmento: Subcontratista de la industria petroquímica (Brasil)
Componente: Brida de bomba
Material: AISI 316 (acero inoxidable forjado, 210 HB)
Refrigerante: Sí, emulsión de aceite soluble en agua (12%)
Aplicación: Giro exterior con interrupciones
Resultados anteriores: Las plaquitas de la competencia tenían problemas para mantener la vida útil de la herramienta a un nivel aceptable, especialmente con cortes interrumpidos que provocaban la rotura repentina de la plaquita.

Resultados con T8415: Nuestras plaquitas de PVD no se rompen durante los cortes interrumpidos y tienen una vida útil total un 120% superior a la segunda mejor plaquita de la competencia probada

Solución Dormer Pramet:

WNMG 080408E-SM:T8415

Datos de mecanizado:

v_c	f_n	a_p
55	0.3	3.0

**WMG M3.2**

Segmento: Subcontratista de mantenimiento y reparación (Brasil)
Componente: Reparación de eje prensa con soldadura
Material: Soldadura CrV (55 HRC)
Refrigerante: No
Aplicación: Corte interrumpido de soldadura con corteza
Resultados anteriores: El grado CVD de la competencia obtuvo resultados bastante satisfactorios y una vida útil de la herramienta estable que finalizó a los 10 minutos.

Resultados con T8415: Conseguimos casi triplicar la vida útil de la herramienta en comparación con la competencia, ¡aumentando de 10 a 28 minutos! El cliente está encantado con este resultado y no puede esperar a comprar nuestra plaquita y utilizarla para trabajos tan exigentes.

Solución Dormer Pramet:

TNMG 160404E-FM:T8415

Datos de mecanizado:

v_c	f_n	a_p
25	0.15	0.4

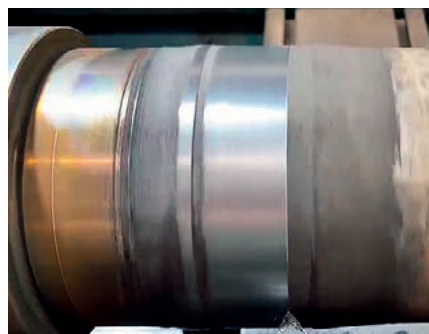
**WMG H3.2**



PLAQUITAS DE TORNEADO

Segmento: Gran fabricante de piezas de automóvil (Brasil)
Componente: Biela trapezoidal
Material: SAE 4140 (acero aleado, 250 HB)
Refrigerante: Sí, emulsión de aceite soluble en agua – taladrina (8%)
Aplicación: Mandrinado del diámetro de un agujero
Resultados anteriores: La configuración es muy estricta y se tienen en cuenta todos los aspectos de la productividad del mecanizado frente a la economía. La plaquita de la competencia tiene una vida útil estable para 100 piezas de trabajo.

Resultados con T8415: Tras pruebas a largo plazo, la plaquita Pramet confirma una vida útil estable de 130 piezas de trabajo, lo que supone un 130% más que una plaquita PVD de la competencia de tipo similar.

Solución Dormer Pramet:

TCMT 110204E-FM:T8415

Datos de mecanizado:

v_c	f_n	a_p
216	0.07	1.0



WMG P3.2

Segmento: Fabricante de piezas para la industria petrolera y del gas (Francia)
Componente: Eje para entornos extremadamente corrosivos
Material: Inconel 718 (HRSA a base de Ni, 36 HRC)
Refrigerante: Sí, emulsión de aceite soluble en agua (12%)
Aplicación: Desbaste longitudinal continuo
Resultados anteriores: La plaquita de la competencia tenía una vida útil fijada en 12 minutos por seguridad del proceso. El cliente necesita evitar roturas repentinas porque la pieza es muy cara.

Resultados con T8415: Las pruebas repetidas a largo plazo han demostrado que somos capaces de alcanzar el doble de vida útil de la herramienta con los mismos parámetros de corte sin ningún problema ni fallo repentino.

Solución Dormer Pramet:

SNMG 120408E-SM:T8415

Datos de mecanizado:

v_c	f_n	a_p
40	0.25	2.5



WMG S3.2

Segmento: Subcontratista de la industria química (Polonia)
Componente: Manguito para eje de bomba de productos químicos
Material: Soldadura de Hastelloy C-276
Refrigerante: Sí, emulsión de aceite soluble en agua – taladrina (8%)
Aplicación: Semidesbaste longitudinal continuo
Resultados anteriores: Ninguna de las plaquitas de la competencia lograron completar ni una sola pasada en la soldadura, de 70 mm de longitud. El mejor competidor dura hasta 30 mm y luego se quema por el calor.

Resultados con T8415: Las pruebas repetidas a largo plazo han demostrado que somos capaces de alcanzar el doble de vida útil de la herramienta con los mismos parámetros de corte sin ningún problema ni fallo repentino.

Solución Dormer Pramet:

CNMG 120408E-NF:T8415

Datos de mecanizado:

v_c	f_n	a_p
10	0.12 – 0.15	1.0



WMG S3.2



PLAQUITAS ISO POSITIVAS – NAVEGADOR DE ROMPEVIRUTAS

 Condiciones de trabajo muy inestables





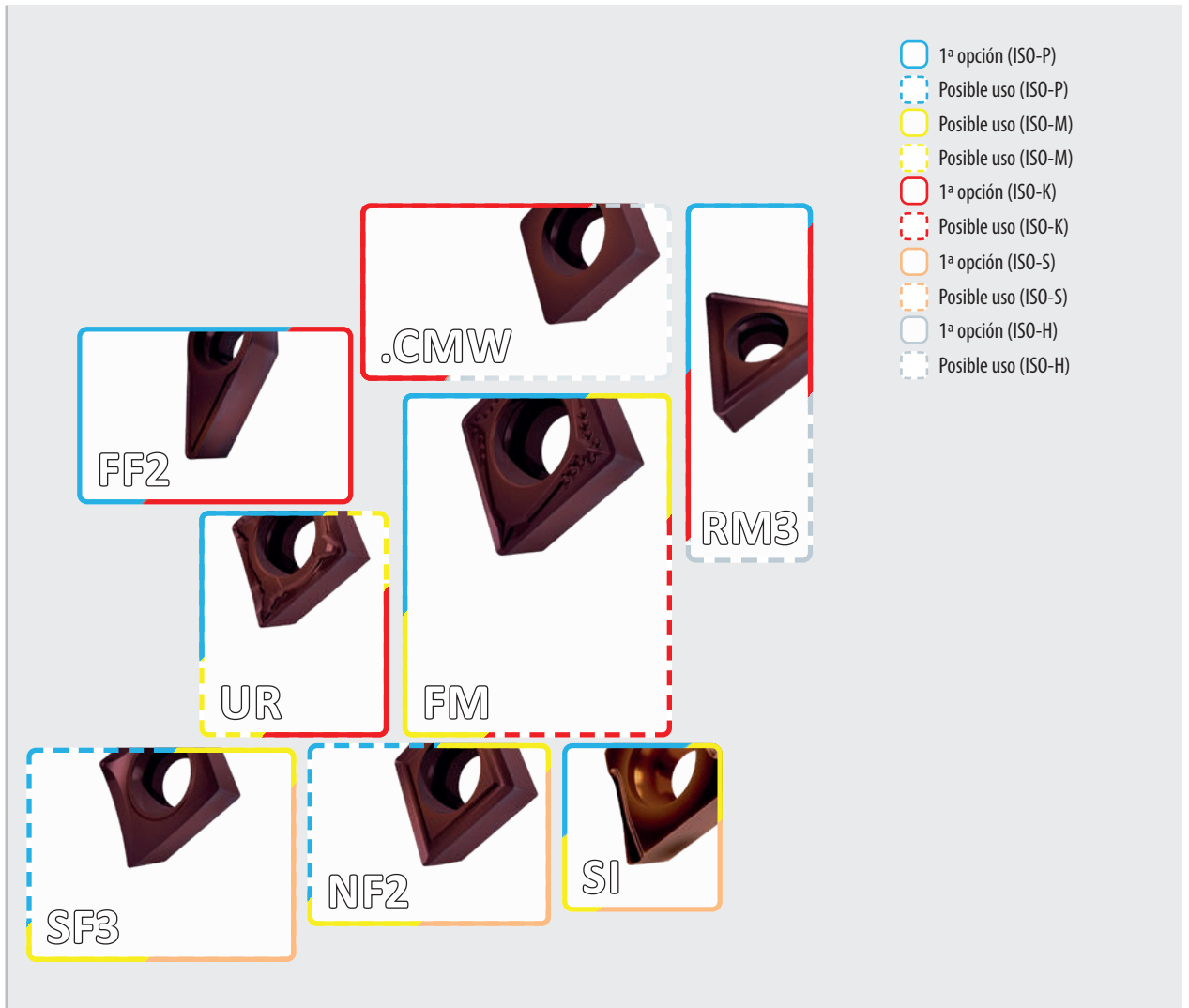

 Condiciones de trabajo inestables

 Condiciones de trabajo estables

 Piezas de trabajo de paredes finas y delgadas



-  1ª opción (ISO-P)
-  Posible uso (ISO-P)
-  Posible uso (ISO-M)
-  Posible uso (ISO-M)
-  1ª opción (ISO-K)
-  Posible uso (ISO-K)
-  1ª opción (ISO-S)
-  Posible uso (ISO-S)
-  1ª opción (ISO-H)
-  Posible uso (ISO-H)

					
	0.05 – 0.2 mm/rev		0.2 – 0.4 mm/rev		> 1.0 mm/rev
	0.05 – 2 mm		2 – 4 mm		> 10 mm

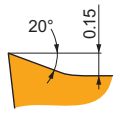
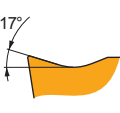
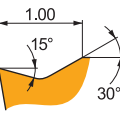
SF3		Diseño para un rectificado preciso altamente positivo en cortes continuos de acabado fino, adecuado para superaleaciones, aceros inoxidables y materiales no féreos, potencialmente acero, fundiciones y materiales duros.
NF2		Diseño positivo para acabados finos hasta cortes continuos medios, adecuado para aceros inoxidables y superaleaciones, potencialmente aceros.
UR		Diseño positivo para acabados finos hasta cortes continuos semidesbastados, adecuado para aceros, aceros potencialmente inoxidables y fundiciones.

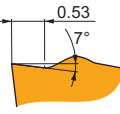
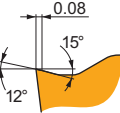
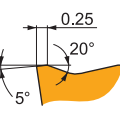
FF2		Diseño ligeramente positivo para acabados finos hasta cortes continuos medios, adecuado para aceros, potencialmente hierros fundidos.
FM		Diseño versátil para cortes de acabado moderadamente interrumpidos hasta cortes semirrugosos continuos, adecuados para aceros y aceros inoxidables, potencialmente hierros fundidos y materiales no ferrosos.
RM3		Diseño robusto con faceta T negativa para cortes interrumpidos de medios a gruesos, adecuado para fundiciones, aceros, materiales potencialmente duros.



PLAQUITA ISO NEGATIVA – NAVEGADOR DE ROMPEVIRUTAS







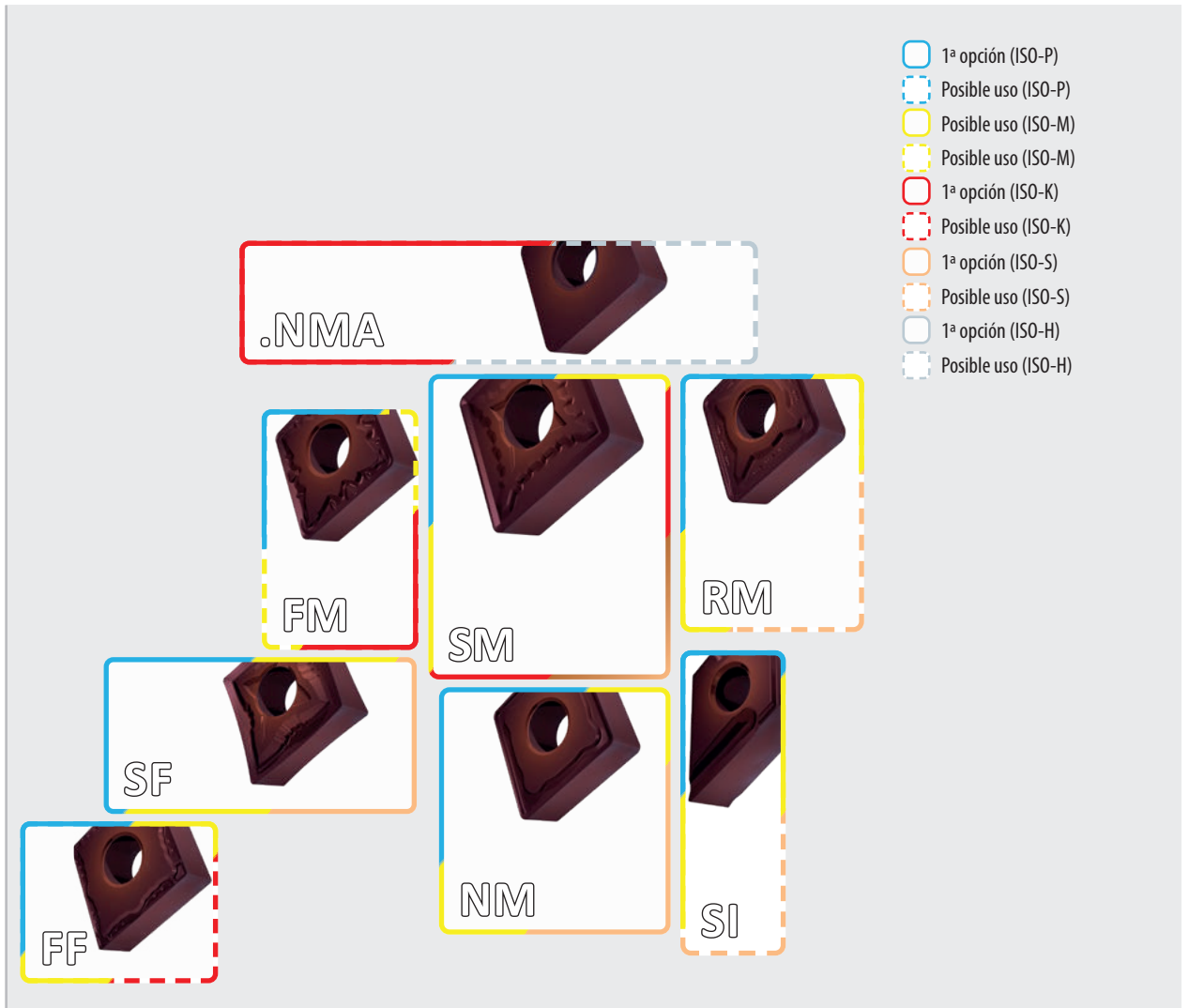

Condiciones de trabajo muy inestables



Condiciones de trabajo inestables

Condiciones de trabajo estables

Piezas de trabajo de paredes finas y delgadas

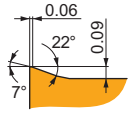
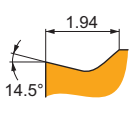
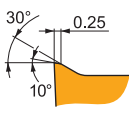
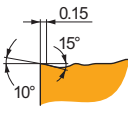
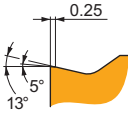
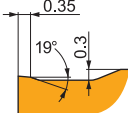

					
 f	0.05 – 0.2 mm/rev	0.2 – 0.4 mm/rev	0.4 – 1.0 mm/rev	> 1.0 mm/rev	
 a_p	0.05 – 2 mm	2 – 4 mm	4 – 10 mm	> 10 mm	

FF		Diseño altamente positivo para cortes continuos de acabado fino, adecuado para aceros y aceros inoxidables, potencialmente hierros fundidos.
SF		Diseño positivo para cortes continuos de acabado fino, adecuado para superaleaciones, aceros inoxidables, aceros, potencialmente hierros fundidos, materiales duros y no ferrosos.
NM		Diseño altamente positivo para cortes continuos desde semiacabados hasta semidesbastados, adecuado para aceros inoxidables, aceros blandos y superaleaciones, potencialmente materiales no férreos.
FM		Diseño positivo para cortes finos moderadamente interrumpidos hasta cortes continuos semi-rugosos, adecuados para aceros, hierros fundidos, potencialmente aceros inoxidables y superaleaciones.
SM		Diseño versátil para cortes ligeros interrumpidos hasta cortes continuos semirrugosos, adecuado para aceros inoxidables, superaleaciones, aceros y fundiciones, potencialmente no férreos y materiales duros.
RM		Diseño versátil estable con faceta T para cortes interrumpidos medios hasta cortes continuos gruesos, adecuado para aceros, aceros inoxidables y fundiciones, potencialmente superaleaciones.



FF2

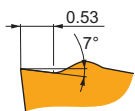

FF2 es un rompevirutas afilado y la primera elección para el acabado fino de aceros. Presenta un ángulo de desprendimiento ligeramente positivo sin faceta T. También es adecuado para fundición.



VCGT

VCGX

	IC	D1	L	S
	(mm)	(mm)	(mm)	(mm)
0702	3.970	2.20	6.90	2.38

	IC	D1	L	S
	(mm)	(mm)	(mm)	(mm)
1303	7.940	3.40	13.80	3.18

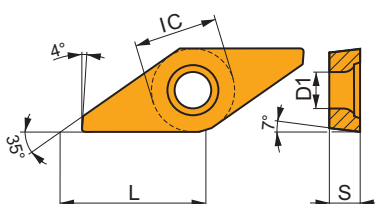
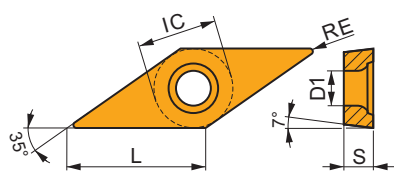

Valores de inicio adecuados para la velocidad de corte (vc), avance (f) y profundidad de corte (ap). Consulte nuestra APP Calculadora de mecanizado para obtener más cálculos.

Producto	Interupted/ Continuous cut	RE (mm)	P			M			K			N			S			H		
			vc (m/min)	f (mm/rev)	ap (mm)	vc (m/min)	f (mm/rev)	ap (mm)	vc (m/min)	f (mm/rev)	ap (mm)	vc (m/min)	f (mm/rev)	ap (mm)	vc (m/min)	f (mm/rev)	ap (mm)	vc (m/min)	f (mm/rev)	ap (mm)

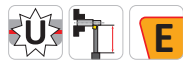
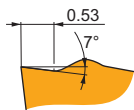

FF2 es un rompevirutas afilado y la primera elección para el acabado fino de aceros. Presenta un ángulo de desprendimiento ligeramente positivo sin faceta T. También es adecuado para fundición.

VCGT 070202E-FF2:T8415	●	0.2	■	185	0.05	0.8	■	165	0.05	0.8	■	160	0.05	1.0	■	180	0.05	1.0	■	180	0.05	1.0
VCGT 070204E-FF2:T8415	●	0.4	■	155	0.12	0.8	■	140	0.12	0.8	■	160	0.05	1.0	■	180	0.05	1.0	■	180	0.05	1.0

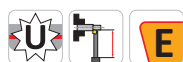
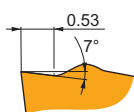

FF2 es un rompevirutas afilado y la primera elección para el acabado fino de aceros. Presenta un ángulo de desprendimiento ligeramente positivo sin faceta T. También es adecuado para fundición.

VCGX 130300FR-FF2:T8415	●	0.0	■	180	0.05	1.0	■	160	0.05	1.0	■	160	0.05	1.0	■	180	0.05	1.0	■	180	0.05	1.0
VCGX 130301FR-FF2:T8415	●	0.1	■	180	0.05	1.0	■	160	0.05	1.0	■	160	0.05	1.0	■	180	0.05	1.0	■	180	0.05	1.0

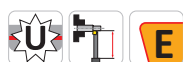
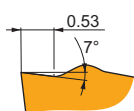

FF2 es un rompevirutas afilado y la primera elección para el acabado fino de aceros. Presenta un ángulo de desprendimiento ligeramente positivo sin faceta T. También es adecuado para fundición.

VCGX 130300FL-FF2:T8415	●	0.0	■	180	0.05	1.0	■	160	0.05	1.0	■	160	0.05	1.0	■	180	0.05	1.0	■	180	0.05	1.0
VCGX 130301FL-FF2:T8415	●	0.1	■	180	0.05	1.0	■	160	0.05	1.0	■	160	0.05	1.0	■	180	0.05	1.0	■	180	0.05	1.0



SF3

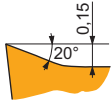

SF3 es un rompevirutas afilado y la primera elección para el acabado fino de aceros inoxidables y superaleaciones. Presenta un ángulo de desprendimiento muy positivo sin faceta T. También es adecuado para aleaciones no férricas, y condicionalmente para aceros, fundiciones y materiales duros.



CCGT

	IC (mm)	D1 (mm)	L (mm)	S (mm)
0602-SF3	6.350	2.80	6.40	2.58
0803-SF3	7.940	3.40	8.10	3.43
09T3-SF3	9.525	4.40	9.70	4.22
1204-SF3	12.700	5.50	12.90	5.01

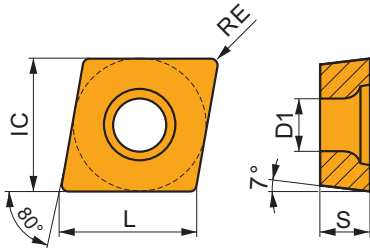

DCGT

	IC (mm)	D1 (mm)	L (mm)	S (mm)
0702-SF3	6.350	2.80	7.80	2.58
11T3-SF3	9.525	4.40	11.60	4.22

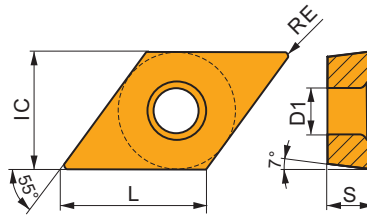

ECGT

	IC (mm)	D1 (mm)	L (mm)	S (mm)
0602-SF3	6.350	2.80	6.50	2.58
0803-SF3	7.940	3.40	8.20	3.43

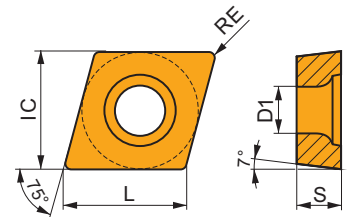

SCGT

	IC (mm)	D1 (mm)	L (mm)	S (mm)
09T3-SF3	9.525	4.40	9.53	4.22

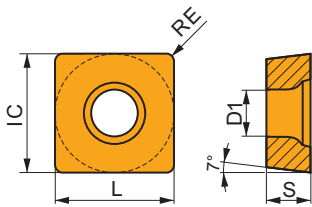

TCGT

	IC (mm)	D1 (mm)	L (mm)	S (mm)
1102-SF3	6.350	2.80	11.00	2.58
16T3-SF3	9.525	4.40	16.50	4.22

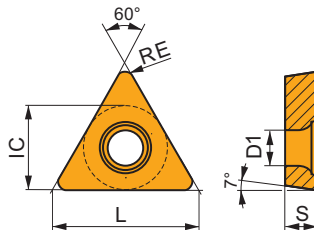

VCGT

	IC (mm)	D1 (mm)	L (mm)	S (mm)
0702	3.970	2.20	6.90	2.38
1102-SF3	6.350	2.80	11.10	2.58
1103-SF3	6.350	2.80	11.10	3.43
1303-SF3	7.940	3.40	13.80	3.43
1604-SF3	9.525	4.40	16.60	5.01

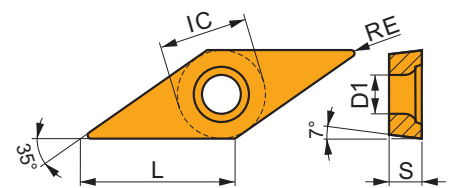

Valores de inicio adecuados para la velocidad de corte (vc), avance (f) y profundidad de corte (ap). Consulte nuestra APP Calculadora de mecanizado para obtener más cálculos.

Producto	Interrupted/ Continuous cut	RE (mm)	P			M			K			N			S			H		
			vc (m/min)	f (mm/rev)	ap (mm)	vc (m/min)	f (mm/rev)	ap (mm)	vc (m/min)	f (mm/rev)	ap (mm)	vc (m/min)	f (mm/rev)	ap (mm)	vc (m/min)	f (mm/rev)	ap (mm)	vc (m/min)	f (mm/rev)	ap (mm)

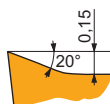
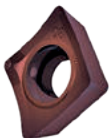

SF3 es un rompevirutas afilado y la primera elección para el acabado fino de aceros inoxidables y superaleaciones. Presenta un ángulo de desprendimiento muy positivo sin faceta T. También es adecuado para aleaciones no férricas, y condicionalmente para aceros, fundiciones y materiales duros.

CCGT 060202E-SF3:T8415	●	0.2	270	0.05	0.8	140	0.04	0.8	245	0.05	0.8	675	0.06	0.8	60	0.04	0.6	45	0.05	0.2
CCGT 060204E-SF3:T8415	●	0.4	230	0.10	0.8	120	0.09	0.8	210	0.10	0.8	585	0.12	0.8	50	0.07	0.6	40	0.07	0.3
CCGT 080302E-SF3:T8415	●	0.2	270	0.05	0.8	140	0.04	0.8	245	0.05	0.8	675	0.06	0.8	60	0.04	0.6	45	0.05	0.2
CCGT 080304E-SF3:T8415	●	0.4	225	0.10	1.0	115	0.09	1.0	205	0.10	1.0	570	0.12	1.0	50	0.07	0.8	35	0.10	0.3
CCGT 09T302E-SF3:T8415	●	0.2	270	0.05	0.8	140	0.04	0.8	245	0.05	0.8	675	0.06	0.8	60	0.04	0.6	45	0.05	0.2
CCGT 09T304E-SF3:T8415	●	0.4	225	0.10	1.0	115	0.09	1.0	205	0.10	1.0	570	0.12	1.0	50	0.07	0.8	35	0.05	0.3
CCGT 09T308E-SF3:T8415	●	0.8	275	0.10	1.0	140	0.09	1.0	250	0.10	1.0	690	0.12	1.0	60	0.08	0.8	45	0.08	0.7
CCGT 120404E-SF3:T8415	●	0.4	225	0.10	1.0	115	0.09	1.0	205	0.10	1.0	570	0.12	1.0	50	0.07	0.8	35	0.07	0.3
CCGT 120408E-SF3:T8415	●	0.8	255	0.12	1.0	135	0.12	1.0	230	0.12	1.0	645	0.14	1.0	55	0.11	0.8	45	0.10	0.7

● Adecuado para condiciones de trabajo estables ● Adecuado para condiciones de trabajo inestables ● Adecuado para condiciones de trabajo duras ■ Uso principal ▣ Uso posible



Valores de inicio adecuados para la velocidad de corte (vc), avance (f) y profundidad de corte (ap). Consulte nuestra APP Calculadora de mecanizado para obtener más cálculos.

Producto	Interrupted/ Continuous cut	RE (mm)	P			M			K			N			S			H		
			vc (m/min)	f (mm/rev)	ap (mm)	vc (m/min)	f (mm/rev)	ap (mm)	vc (m/min)	f (mm/rev)	ap (mm)	vc (m/min)	f (mm/rev)	ap (mm)	vc (m/min)	f (mm/rev)	ap (mm)	vc (m/min)	f (mm/rev)	ap (mm)

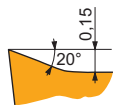

SF3 es un rompevirutas afilado y la primera elección para el acabado fino de aceros inoxidables y superaleaciones. Presenta un ángulo de desprendimiento muy positivo sin faceta T. También es adecuado para aleaciones no férricas, y condicionalmente para aceros, fundiciones y materiales duros.

DCGT 070202E-SF3:T8415	●	0.2	215	0.05	0.8	110	0.04	0.8	195	0.05	0.8	540	0.06	0.8	45	0.04	0.6	35	0.05	0.2
DCGT 070204E-SF3:T8415	●	0.4	185	0.10	0.8	95	0.09	0.8	165	0.10	0.8	465	0.12	0.8	40	0.07	0.6	30	0.07	0.3
DCGT 11T302E-SF3:T8415	●	0.2	215	0.05	0.8	110	0.04	0.8	195	0.05	0.8	540	0.06	0.8	45	0.04	0.6	35	0.05	0.2
DCGT 11T304E-SF3:T8415	●	0.4	185	0.10	0.8	95	0.09	0.8	165	0.10	0.8	465	0.12	0.8	40	0.07	0.6	30	0.07	0.3
DCGT 11T308E-SF3:T8415	●	0.8	220	0.10	0.8	115	0.09	0.8	200	0.10	0.8	555	0.12	0.8	50	0.08	0.6	35	0.08	0.7

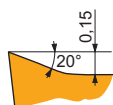
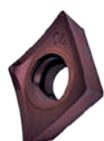

SF3 es un rompevirutas afilado y la primera elección para el acabado fino de aceros inoxidables y superaleaciones. Presenta un ángulo de desprendimiento muy positivo sin faceta T. También es adecuado para aleaciones no férricas, y condicionalmente para aceros, fundiciones y materiales duros.

ECGT 060202E-SF3:T8415	●	0.2	240	0.05	0.8	125	0.04	0.8	215	0.05	0.8	600	0.06	0.8	55	0.04	0.6	40	0.05	0.2
ECGT 080304E-SF3:T8415	●	0.4	200	0.10	1.0	105	0.09	1.0	185	0.10	1.0	510	0.12	1.0	45	0.07	0.8	35	0.05	0.3

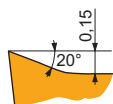
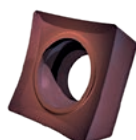

SF3 es un rompevirutas afilado y la primera elección para el acabado fino de aceros inoxidables y superaleaciones. Presenta un ángulo de desprendimiento muy positivo sin faceta T. También es adecuado para aleaciones no férricas, y condicionalmente para aceros, fundiciones y materiales duros.

SCGT 09T304E-SF3:T8415	●	0.4	240	0.10	1.0	125	0.09	1.0	215	0.10	1.0	600	0.12	1.0	55	0.07	0.8	40	0.05	0.3
SCGT 09T308E-SF3:T8415	⚙	0.8	270	0.12	1.0	140	0.12	1.0	245	0.12	1.0	675	0.14	1.0	60	0.11	0.8	45	0.10	0.7

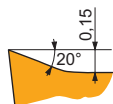
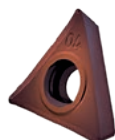

SF3 es un rompevirutas afilado y la primera elección para el acabado fino de aceros inoxidables y superaleaciones. Presenta un ángulo de desprendimiento muy positivo sin faceta T. También es adecuado para aleaciones no férricas, y condicionalmente para aceros, fundiciones y materiales duros.

TCGT 110202E-SF3:T8415	●	0.2	225	0.05	0.8	115	0.04	0.8	205	0.05	0.8	570	0.06	0.8	50	0.04	0.6	35	0.05	0.2
TCGT 110204E-SF3:T8415	●	0.4	195	0.10	0.8	100	0.09	0.8	180	0.10	0.8	495	0.12	0.8	45	0.07	0.6	30	0.07	0.3
TCGT 16T304E-SF3:T8415	●	0.4	195	0.10	1.0	100	0.09	1.0	180	0.10	1.0	495	0.12	1.0	45	0.07	0.8	30	0.07	0.3
TCGT 16T308E-SF3:T8415	●	0.8	225	0.10	1.2	115	0.09	1.2	205	0.10	1.2	570	0.12	1.2	50	0.08	1.0	35	0.08	0.7
TCGT 16T312E-SF3:T8415	●	1.2	190	0.20	1.2	100	0.18	1.2	170	0.20	1.2	480	0.24	1.2	40	0.14	1.0	30	0.10	0.9

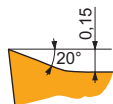

SF3 es un rompevirutas afilado y la primera elección para el acabado fino de aceros inoxidables y superaleaciones. Presenta un ángulo de desprendimiento muy positivo sin faceta T. También es adecuado para aleaciones no férricas, y condicionalmente para aceros, fundiciones y materiales duros.

VCGT 070202E-SF3:T8415	●	0.2	185	0.05	0.8	95	0.04	0.8	165	0.05	0.8	465	0.06	0.8	40	0.04	0.6	30	0.05	0.2
VCGT 070204E-SF3:T8415	●	0.4	160	0.10	0.8	85	0.09	0.8	145	0.10	0.8	405	0.12	0.8	35	0.07	0.6	25	0.07	0.3
VCGT 110202E-SF3:T8415	●	0.2	185	0.05	0.8	95	0.04	0.8	165	0.05	0.8	465	0.06	0.8	40	0.04	0.6	30	0.05	0.2
VCGT 110204E-SF3:T8415	●	0.4	160	0.10	0.8	85	0.09	0.8	145	0.10	0.8	405	0.12	0.8	35	0.07	0.6	25	0.07	0.3
VCGT 110304E-SF3:T8415	●	0.4	160	0.10	0.8	85	0.09	0.8	145	0.10	0.8	405	0.12	0.8	35	0.07	0.6	25	0.07	0.3
VCGT 130302E-SF3:T8415	●	0.2	185	0.05	0.8	95	0.04	0.8	165	0.05	0.8	465	0.06	0.8	40	0.04	0.6	30	0.05	0.2
VCGT 130304E-SF3:T8415	●	0.4	160	0.10	1.0	85	0.09	1.0	145	0.10	1.0	405	0.12	1.0	35	0.07	0.8	25	0.07	0.3
VCGT 130308E-SF3:T8415	●	0.8	190	0.10	1.0	100	0.09	1.0	170	0.10	1.0	480	0.12	1.0	40	0.08	0.8	30	0.08	0.7
VCGT 160402E-SF3:T8415	●	0.2	185	0.05	0.8	95	0.04	0.8	165	0.05	0.8	465	0.06	0.8	40	0.04	0.6	30	0.05	0.2
VCGT 160404E-SF3:T8415	●	0.4	160	0.10	1.0	85	0.09	1.0	145	0.10	1.0	405	0.12	1.0	35	0.07	0.8	25	0.07	0.3
VCGT 160408E-SF3:T8415	●	0.8	185	0.10	1.2	95	0.09	1.2	165	0.10	1.2	465	0.12	1.2	40	0.08	1.0	30	0.08	0.7
VCGT 160412E-SF3:T8415	●	1.2	160	0.20	1.2	85	0.18	1.2	145	0.20	1.2	405	0.24	1.2	35	0.14	1.0	25	0.10	0.9

● Adecuado para condiciones de trabajo estables ⚙ Adecuado para condiciones de trabajo inestables ⚙ Adecuado para condiciones de trabajo duras ■ Uso principal ☑ Uso posible



FM

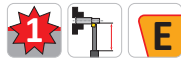
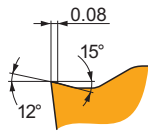

FM es un rompevirutas versátil y la primera elección para el acabado de aceros. Se caracteriza por un ángulo de desprendimiento positivo y una faceta T positiva y estrecha. También es adecuado para aceros inoxidables y, condicionalmente, para fundiciones y aleaciones no férricas.



CCMT

	IC (mm)	D1 (mm)	L (mm)	S (mm)
0602	6.350	2.80	6.40	2.38
09T3	9.525	4.40	9.70	3.97
1204	12.700	5.50	12.90	4.76

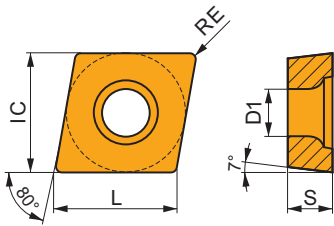

DCMT

	IC (mm)	D1 (mm)	L (mm)	S (mm)
0702	6.350	2.80	7.80	2.38
11T3	9.525	4.40	11.60	3.97

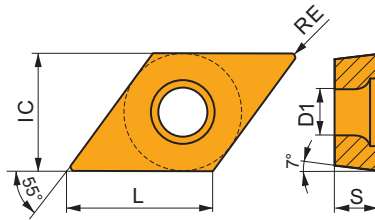

SCMT

	IC (mm)	D1 (mm)	L (mm)	S (mm)
09T3	9.525	4.40	9.53	3.97
1204	12.700	5.50	12.70	4.76

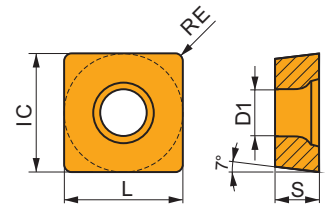

TCMT

	IC (mm)	D1 (mm)	L (mm)	S (mm)
1102	6.350	2.80	11.00	2.38
16T3	9.525	4.40	16.50	3.97

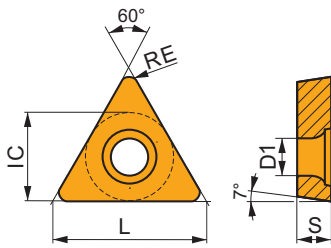

VBMT

	IC (mm)	D1 (mm)	L (mm)	S (mm)
1103	6.350	2.80	11.10	3.18
1604	9.525	4.40	16.60	4.76

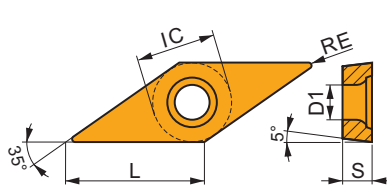

WCMT

	IC (mm)	D1 (mm)	L (mm)	S (mm)
06T3	9.525	4.40	6.50	3.97

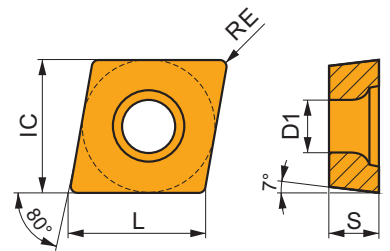

Valores de inicio adecuados para la velocidad de corte (vc), avance (f) y profundidad de corte (ap). Consulte nuestra APP Calculadora de mecanizado para obtener más cálculos.

Producto	Interrupted/ Continuous cut	RE (mm)	P			M			K			N			S			H		
			vc (m/min)	f (mm/rev)	ap (mm)	vc (m/min)	f (mm/rev)	ap (mm)	vc (m/min)	f (mm/rev)	ap (mm)	vc (m/min)	f (mm/rev)	ap (mm)	vc (m/min)	f (mm/rev)	ap (mm)	vc (m/min)	f (mm/rev)	ap (mm)

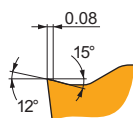
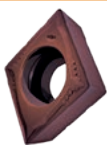

FM es un rompevirutas versátil y la primera elección para el acabado de aceros. Se caracteriza por un ángulo de desprendimiento positivo y una faceta T positiva y estrecha. También es adecuado para aceros inoxidables y, condicionalmente, para fundiciones y aleaciones no férricas.

CCMT 060202E-FM:T8415	●	0.2	■	240	0.10	1.0	■	125	0.09	1.0	■	215	0.10	1.0	■	600	0.12	1.0	-	-	-	-	-	-
CCMT 060204E-FM:T8415	●	0.4	■	225	0.15	1.0	■	115	0.14	1.0	■	205	0.15	1.0	■	570	0.18	1.0	-	-	-	-	-	-
CCMT 09T302E-FM:T8415	●	0.2	■	230	0.10	1.2	■	120	0.09	1.2	■	210	0.10	1.2	■	585	0.12	1.2	-	-	-	-	-	-
CCMT 09T304E-FM:T8415	●	0.4	■	220	0.15	1.2	■	115	0.14	1.2	■	200	0.15	1.2	■	555	0.18	1.2	-	-	-	-	-	-
CCMT 09T308E-FM:T8415	●	0.8	■	240	0.20	1.2	■	125	0.18	1.2	■	215	0.20	1.2	■	600	0.24	1.2	-	-	-	-	-	-
CCMT 120404E-FM:T8415	●	0.4	■	210	0.15	1.7	■	110	0.14	1.7	■	190	0.15	1.7	■	525	0.18	1.7	-	-	-	-	-	-
CCMT 120408E-FM:T8415	●	0.8	■	230	0.20	1.7	■	120	0.18	1.7	■	210	0.20	1.7	■	585	0.24	1.7	-	-	-	-	-	-

● Adecuado para condiciones de trabajo estables ● Adecuado para condiciones de trabajo inestables ● Adecuado para condiciones de trabajo duras ■ Uso principal ■ Uso posible



Valores de inicio adecuados para la velocidad de corte (vc), avance (f) y profundidad de corte (ap). Consulte nuestra APP Calculadora de mecanizado para obtener más cálculos.

Producto	Interrupted/ Continuous cut	RE (mm)	P			M			K			N			S			H		
			vc	f	ap	vc	f	ap	vc	f	ap	vc	f	ap	vc	f	ap	vc	f	ap
			(m/min)	(mm/rev)	(mm)	(m/min)	(mm/rev)	(mm)	(m/min)	(mm/rev)	(mm)	(m/min)	(mm/rev)	(mm)	(m/min)	(mm/rev)	(mm)	(m/min)	(mm/rev)	(mm)

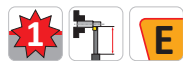
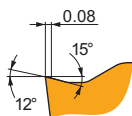

FM es un rompevirutas versátil y la primera elección para el acabado de aceros. Se caracteriza por un ángulo de desprendimiento positivo y una faceta T positiva y estrecha. También es adecuado para aceros inoxidables y, condicionalmente, para fundiciones y aleaciones no férricas.

DCMT 070202E-FM:T8415	●	0.2	190	0.10	0.8	100	0.09	0.8	170	0.10	0.8	480	0.12	0.8	-	-	-	-	-	-
DCMT 070204E-FM:T8415	●	0.4	190	0.12	0.8	100	0.11	0.8	170	0.12	0.8	480	0.14	0.8	-	-	-	-	-	-
DCMT 11T302E-FM:T8415	●	0.2	190	0.10	0.8	100	0.09	0.8	170	0.10	0.8	480	0.12	0.8	-	-	-	-	-	-
DCMT 11T304E-FM:T8415	●	0.4	190	0.12	0.8	100	0.11	0.8	170	0.12	0.8	480	0.14	0.8	-	-	-	-	-	-
DCMT 11T308E-FM:T8415	●	0.8	210	0.17	0.8	110	0.15	0.8	190	0.17	0.8	525	0.20	0.8	-	-	-	-	-	-

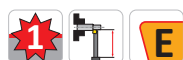
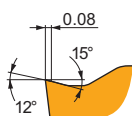
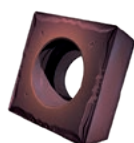

FM es un rompevirutas versátil y la primera elección para el acabado de aceros. Se caracteriza por un ángulo de desprendimiento positivo y una faceta T positiva y estrecha. También es adecuado para aceros inoxidables y, condicionalmente, para fundiciones y aleaciones no férricas.

SCMT 09T304E-FM:T8415	●	0.4	230	0.15	1.2	120	0.14	1.2	210	0.15	1.2	585	0.18	1.2	-	-	-	-	-	-
SCMT 09T308E-FM:T8415	●	0.8	250	0.20	1.2	130	0.18	1.2	225	0.20	1.2	630	0.24	1.2	-	-	-	-	-	-
SCMT 120404E-FM:T8415	●	0.4	225	0.15	1.6	115	0.14	1.6	205	0.15	1.6	570	0.18	1.6	-	-	-	-	-	-
SCMT 120408E-FM:T8415	●	0.8	245	0.20	1.6	125	0.18	1.6	220	0.20	1.6	615	0.24	1.6	-	-	-	-	-	-

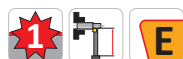
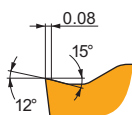
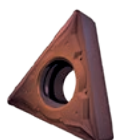

FM es un rompevirutas versátil y la primera elección para el acabado de aceros. Se caracteriza por un ángulo de desprendimiento positivo y una faceta T positiva y estrecha. También es adecuado para aceros inoxidables y, condicionalmente, para fundiciones y aleaciones no férricas.

TCMT 110202E-FM:T8415	●	0.2	200	0.10	0.8	105	0.09	0.8	185	0.10	0.8	510	0.12	0.8	-	-	-	-	-	-
TCMT 110204E-FM:T8415	●	0.4	210	0.12	0.8	110	0.11	0.8	190	0.12	0.8	525	0.14	0.8	-	-	-	-	-	-
TCMT 16T304E-FM:T8415	●	0.4	190	0.12	1.7	100	0.11	1.7	170	0.12	1.7	480	0.14	1.7	-	-	-	-	-	-
TCMT 16T308E-FM:T8415	●	0.8	210	0.17	1.7	110	0.15	1.7	190	0.17	1.7	525	0.20	1.7	-	-	-	-	-	-

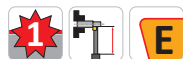
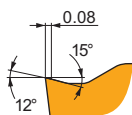

FM es un rompevirutas versátil y la primera elección para el acabado de aceros. Se caracteriza por un ángulo de desprendimiento positivo y una faceta T positiva y estrecha. También es adecuado para aceros inoxidables y, condicionalmente, para fundiciones y aleaciones no férricas.

VBMT 110302E-FM:T8415	●	0.2	180	0.10	0.8	90	0.09	0.8	160	0.10	0.8	450	0.12	0.8	-	-	-	-	-	-
VBMT 110304E-FM:T8415	●	0.4	180	0.12	0.8	90	0.11	0.8	160	0.12	0.8	450	0.14	0.8	-	-	-	-	-	-
VBMT 160404E-FM:T8415	●	0.4	170	0.12	1.2	90	0.11	1.2	155	0.12	1.2	435	0.14	1.2	-	-	-	-	-	-
VBMT 160408E-FM:T8415	●	0.8	185	0.17	1.2	95	0.15	1.2	165	0.17	1.2	465	0.20	1.2	-	-	-	-	-	-

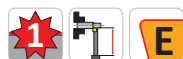
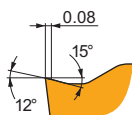
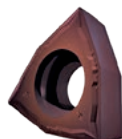

FM es un rompevirutas versátil y la primera elección para el acabado de aceros. Se caracteriza por un ángulo de desprendimiento positivo y una faceta T positiva y estrecha. También es adecuado para aceros inoxidables y, condicionalmente, para fundiciones y aleaciones no férricas.

WCMT 06T304E-FM:T8415	●	0.4	220	0.15	1.2	115	0.14	1.2	200	0.15	1.2	555	0.18	1.2	-	-	-	-	-	-
WCMT 06T308E-FM:T8415	●	0.8	240	0.20	1.2	125	0.18	1.2	215	0.20	1.2	600	0.24	1.2	-	-	-	-	-	-



NF2

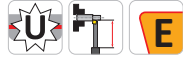
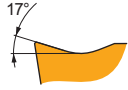

NF2 es un rompevirutas afilado y la primera elección para el acabado de aceros inoxidable. Presenta un ángulo de desprendimiento positivo sin faceta T. También es adecuado para superaleaciones y, condicionalmente, para aceros, fundiciones y aleaciones no férricas.



CCMT

VCGT

	IC (mm)	D1 (mm)	L (mm)	S (mm)
0602	6.350	2.80	6.40	2.38
09T3	9.525	4.40	9.70	3.97

	IC (mm)	D1 (mm)	L (mm)	S (mm)
1303	7.940	3.40	13.80	3.18

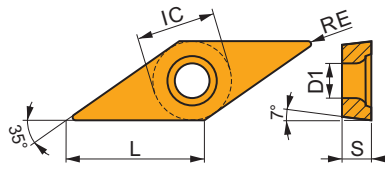
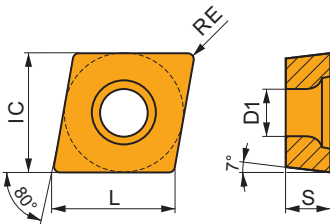

Valores de inicio adecuados para la velocidad de corte (vc), avance (f) y profundidad de corte (ap). Consulte nuestra APP Calculadora de mecanizado para obtener más cálculos.

Producto	Interrupted/ Continuous cut	RE (mm)	P			M			K			N			S			H		
			vc (m/min)	f (mm/rev)	ap (mm)	vc (m/min)	f (mm/rev)	ap (mm)	vc (m/min)	f (mm/rev)	ap (mm)	vc (m/min)	f (mm/rev)	ap (mm)	vc (m/min)	f (mm/rev)	ap (mm)	vc (m/min)	f (mm/rev)	ap (mm)

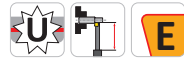
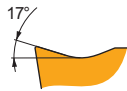
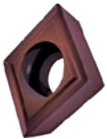

NF2 es un rompevirutas afilado y la primera elección para el acabado de aceros inoxidable. Presenta un ángulo de desprendimiento positivo sin faceta T. También es adecuado para superaleaciones y, condicionalmente, para aceros, fundiciones y aleaciones no férricas.

CCMT 060202E-NF2:T8415	●	0.2	220	0.10	0.8	115	0.09	0.8	200	0.10	0.8	555	0.12	0.8	50	0.08	0.6	-	-	-
CCMT 060204E-NF2:T8415	●	0.4	220	0.12	0.8	115	0.11	0.8	200	0.12	0.8	555	0.14	0.8	50	0.11	0.6	-	-	-
CCMT 09T304E-NF2:T8415	●	0.4	215	0.12	1.2	110	0.11	1.2	195	0.12	1.2	540	0.14	1.2	45	0.11	1.0	-	-	-
CCMT 09T308E-NF2:T8415	●	0.8	245	0.14	1.2	125	0.13	1.2	220	0.14	1.2	615	0.17	1.2	55	0.13	1.0	-	-	-

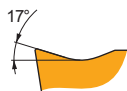

NF2 es un rompevirutas afilado y la primera elección para el acabado de aceros inoxidable. Presenta un ángulo de desprendimiento positivo sin faceta T. También es adecuado para superaleaciones y, condicionalmente, para aceros, fundiciones y aleaciones no férricas.

VCGT 130302E-NF2:T8415	●	0.2	160	0.07	1.0	85	0.06	1.0	145	0.07	1.0	405	0.08	1.0	35	0.06	0.8	-	-	-
VCGT 130304E-NF2:T8415	●	0.4	150	0.12	1.0	75	0.11	1.0	135	0.12	1.0	375	0.14	1.0	30	0.11	0.8	-	-	-
VCGT 130308E-NF2:T8415	●	0.8	160	0.17	1.0	85	0.15	1.0	145	0.17	1.0	405	0.20	1.0	35	0.12	0.8	-	-	-



UR

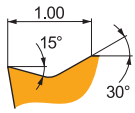

UR es un rompevirutas versátil y la primera elección para el acabado de fundición. Presenta un ángulo de desprendimiento positivo sin faceta T. También es adecuado para aceros, y condicionalmente para aceros inoxidables.



CCMT

	IC (mm)	D1 (mm)	L (mm)	S (mm)
0602	6.350	2.80	6.40	2.38
09T3	9.525	4.40	9.70	3.97

DCMT

	IC (mm)	D1 (mm)	L (mm)	S (mm)
0702	6.350	2.80	7.80	2.38
11T3	9.525	4.40	11.60	3.97

RCMT

	INSD (mm)	D1 (mm)	S (mm)
0602	6.000	2.80	2.38
0803	8.000	3.40	3.18
10T3	10.000	4.40	3.97
1204	12.000	4.40	4.76

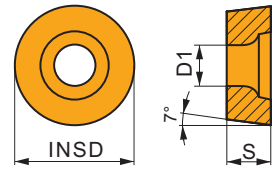
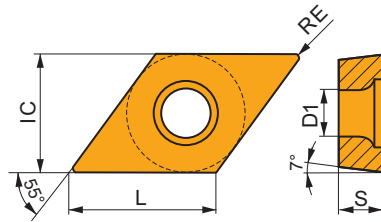
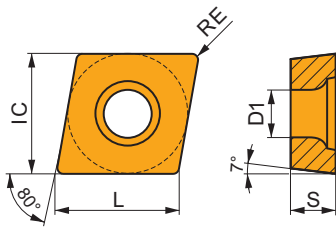

Valores de inicio adecuados para la velocidad de corte (vc), avance (f) y profundidad de corte (ap). Consulte nuestra APP Calculadora de mecanizado para obtener más cálculos.

Producto	Interrupted/ Continuous cut	RE (mm)	P			M			K			N			S			H		
			vc (m/min)	f (mm/rev)	ap (mm)	vc (m/min)	f (mm/rev)	ap (mm)	vc (m/min)	f (mm/rev)	ap (mm)	vc (m/min)	f (mm/rev)	ap (mm)	vc (m/min)	f (mm/rev)	ap (mm)	vc (m/min)	f (mm/rev)	ap (mm)

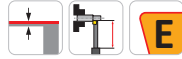
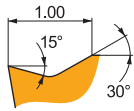
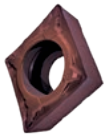

UR es un rompevirutas versátil y la primera elección para el acabado de fundición. Presenta un ángulo de desprendimiento positivo sin faceta T. También es adecuado para aceros, y condicionalmente para aceros inoxidables.

CCMT 060202E-UR:T8415	●	0.2	210	0.10	0.8	110	0.09	0.8	190	0.10	0.8	-	-	-	-	-	-	-	-
CCMT 060204E-UR:T8415	●	0.4	190	0.15	1.0	100	0.14	1.0	170	0.15	1.0	-	-	-	-	-	-	-	-
CCMT 09T302E-UR:T8415	●	0.2	200	0.10	1.0	105	0.09	1.0	185	0.10	1.0	-	-	-	-	-	-	-	-
CCMT 09T304E-UR:T8415	●	0.4	190	0.15	1.2	100	0.14	1.2	170	0.15	1.2	-	-	-	-	-	-	-	-
CCMT 09T308E-UR:T8415	●	0.8	200	0.20	1.2	105	0.18	1.2	185	0.20	1.2	-	-	-	-	-	-	-	-

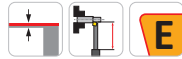
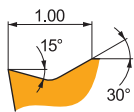

UR es un rompevirutas versátil y la primera elección para el acabado de fundición. Presenta un ángulo de desprendimiento positivo sin faceta T. También es adecuado para aceros, y condicionalmente para aceros inoxidables.

DCMT 070202E-UR:T8415	●	0.2	165	0.10	0.8	85	0.09	0.8	150	0.10	0.8	-	-	-	-	-	-	-	-
DCMT 070204E-UR:T8415	●	0.4	165	0.12	0.8	85	0.11	0.8	150	0.12	0.8	-	-	-	-	-	-	-	-
DCMT 11T304E-UR:T8415	●	0.4	165	0.12	0.8	85	0.11	0.8	150	0.12	0.8	-	-	-	-	-	-	-	-
DCMT 11T308E-UR:T8415	●	0.8	180	0.17	0.8	90	0.15	0.8	160	0.17	0.8	-	-	-	-	-	-	-	-

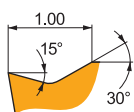
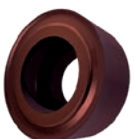

UR es un rompevirutas versátil y la primera elección para el acabado de fundición. Presenta un ángulo de desprendimiento positivo sin faceta T. También es adecuado para aceros, y condicionalmente para aceros inoxidables.

RCMT 0602MOE-UR:T8415	⚙	-	220	0.40	1.2	115	0.36	1.2	200	0.40	1.2	-	-	-	-	-	-	-	-
RCMT 0803MOE-UR:T8415	⚙	-	200	0.45	1.6	105	0.41	1.6	185	0.45	1.6	-	-	-	-	-	-	-	-
RCMT 10T3MOE-UR:T8415	⚙	-	200	0.50	1.4	105	0.45	1.4	185	0.50	1.4	-	-	-	-	-	-	-	-
RCMT 1204MOE-UR:T8415	⚙	-	190	0.55	1.8	100	0.49	1.8	170	0.55	1.8	-	-	-	-	-	-	-	-

● Adecuado para condiciones de trabajo estables ⚙ Adecuado para condiciones de trabajo inestables ⚙ Adecuado para condiciones de trabajo duras ■ Uso principal ☑ Uso posible



SI

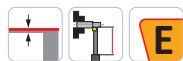

SI es un rompevirutas afilado y la primera elección para el mecanizado medio de aceros inoxidable. Presenta un ángulo de desprendimiento muy positivo sin faceta T. También es adecuado para aceros, superaleaciones y, condicionalmente, para fundiciones.



CCGT

	IC (mm)	D1 (mm)	L (mm)	S (mm)
0602	6.350	2.80	6.40	2.38
09T3	9.525	4.40	9.70	3.97

TCGT

	IC (mm)	D1 (mm)	L (mm)	S (mm)
1102	6.350	2.80	11.00	2.38

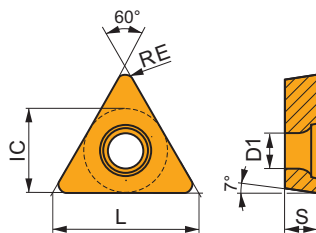
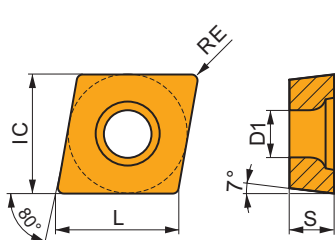

Valores de inicio adecuados para la velocidad de corte (vc), avance (f) y profundidad de corte (ap). Consulte nuestra APP Calculadora de mecanizado para obtener más cálculos.

Producto	Interrupted/ Continuous cut	RE (mm)	P			M			K			N			S			H		
			vc (m/min)	f (mm/rev)	ap (mm)	vc (m/min)	f (mm/rev)	ap (mm)	vc (m/min)	f (mm/rev)	ap (mm)	vc (m/min)	f (mm/rev)	ap (mm)	vc (m/min)	f (mm/rev)	ap (mm)	vc (m/min)	f (mm/rev)	ap (mm)

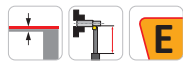
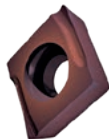

SI es un rompevirutas afilado y la primera elección para el mecanizado medio de aceros inoxidable. Presenta un ángulo de desprendimiento muy positivo sin faceta T. También es adecuado para aceros, superaleaciones y, condicionalmente, para fundiciones.

CCGT 060204EL-SI-T8415	●	0.4	■	275	0.12	0.8	■	140	0.11	0.8	▣	250	0.12	0.8	■	60	0.10	0.6	■	-	-	-	■	55	0.15	0.6	■	-	-	-
CCGT 09T304EL-SI-T8415	●	0.4	■	250	0.17	0.8	■	130	0.15	0.8	▣	225	0.17	0.8	■	-	-	-	■	-	-	-	■	-	-	-	■	-	-	-

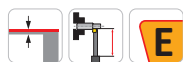

SI es un rompevirutas afilado y la primera elección para el mecanizado medio de aceros inoxidable. Presenta un ángulo de desprendimiento muy positivo sin faceta T. También es adecuado para aceros, superaleaciones y, condicionalmente, para fundiciones.

TCGT 110202EL-SI-T8415	●	0.2	■	230	0.10	0.8	■	120	0.09	0.8	▣	210	0.10	0.8	■	50	0.08	0.6	■	-	-	-	■	-	-	-	■	-	-	-
TCGT 110204EL-SI-T8415	●	0.4	■	230	0.12	0.8	■	120	0.11	0.8	▣	210	0.12	0.8	■	-	-	-	■	-	-	-	■	-	-	-	■	-	-	-



CMW



...W es una plaquita plana diseñada para el mecanizado medio de fundición. Presenta un ángulo de desprendimiento neutro sin faceta T. También es condicionalmente adecuada para materiales duros.



CCMW

	IC (mm)	D1 (mm)	L (mm)	S (mm)
0602	6.350	2.80	6.40	2.38
09T3	9.525	4.40	9.70	3.97

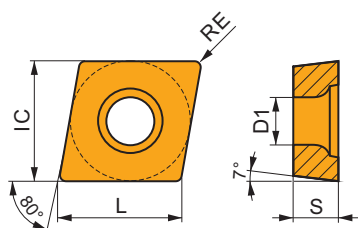

DCMW

	IC (mm)	D1 (mm)	L (mm)	S (mm)
0702	6.350	2.80	7.80	2.38
11T3	9.525	4.40	11.60	3.97

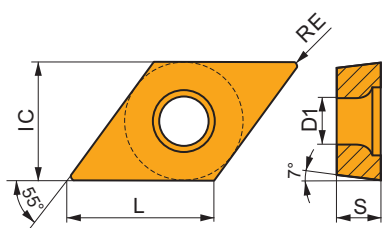

TCMW

	IC (mm)	D1 (mm)	L (mm)	S (mm)
16T3	9.525	4.40	16.50	3.97

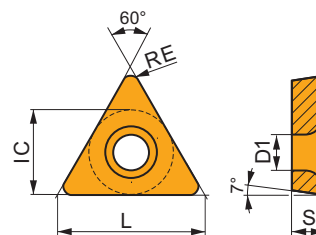

WCMW

	IC (mm)	D1 (mm)	L (mm)	S (mm)
1103	6.350	2.80	11.10	3.18
1604	9.525	4.40	16.60	4.76

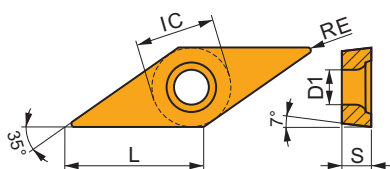

Valores de inicio adecuados para la velocidad de corte (vc), avance (f) y profundidad de corte (ap). Consulte nuestra APP Calculadora de mecanizado para obtener más cálculos.

Producto	Interrupted/ Continuous cut	RE (mm)	P			M			K			N			S			H				
			vc (m/min)	f (mm/rev)	ap (mm)	vc (m/min)	f (mm/rev)	ap (mm)	vc (m/min)	f (mm/rev)	ap (mm)	vc (m/min)	f (mm/rev)	ap (mm)	vc (m/min)	f (mm/rev)	ap (mm)	vc (m/min)	f (mm/rev)	ap (mm)		
CCMW 060204:T8415	●	0.4	-	-	-	-	-	-	■	145	0.10	2.0	-	-	-	-	-	-	▣	25	0.10	0.3
CCMW 09T304:T8415	●	0.4	-	-	-	-	-	-	■	135	0.10	3.0	-	-	-	-	-	-	▣	25	0.10	0.3
CCMW 09T308:T8415	⚡	0.8	-	-	-	-	-	-	■	135	0.20	3.0	-	-	-	-	-	-	▣	25	0.11	0.7

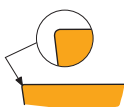
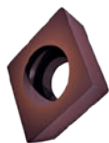

...W es una plaquita plana diseñada para el mecanizado medio de fundición. Presenta un ángulo de desprendimiento neutro sin faceta T. También es condicionalmente adecuada para materiales duros.

CCMW 060204:T8415	●	0.4	-	-	-	-	-	-	■	145	0.10	2.0	-	-	-	-	-	-	▣	25	0.10	0.3
CCMW 09T304:T8415	●	0.4	-	-	-	-	-	-	■	135	0.10	3.0	-	-	-	-	-	-	▣	25	0.10	0.3
CCMW 09T308:T8415	⚡	0.8	-	-	-	-	-	-	■	135	0.20	3.0	-	-	-	-	-	-	▣	25	0.11	0.7

● Adecuado para condiciones de trabajo estables ⚡ Adecuado para condiciones de trabajo inestables ⚡ Adecuado para condiciones de trabajo duras ■ Uso principal ▣ Uso posible



Valores de inicio adecuados para la velocidad de corte (vc), avance (f) y profundidad de corte (ap). Consulte nuestra APP Calculadora de mecanizado para obtener más cálculos.

Producto	Interrupted/ Continuous cut	RE (mm)	P			M			K			N			S			H		
			vc (m/min)	f (mm/rev)	ap (mm)	vc (m/min)	f (mm/rev)	ap (mm)	vc (m/min)	f (mm/rev)	ap (mm)	vc (m/min)	f (mm/rev)	ap (mm)	vc (m/min)	f (mm/rev)	ap (mm)	vc (m/min)	f (mm/rev)	ap (mm)



...W es una plaquita plana diseñada para el mecanizado medio de fundición. Presenta un ángulo de desprendimiento neutro sin faceta T. También es condicionalmente adecuada para materiales duros.

DCMW 070204:T8415	●	0.4	-	-	-	-	-	-	■	125	0.10	0.8	-	-	-	-	-	-	☑	20	0.10	0.3
DCMW 11T304:T8415	●	0.4	-	-	-	-	-	-	■	120	0.10	1.2	-	-	-	-	-	-	☑	20	0.10	0.3
DCMW 11T308:T8415	●	0.8	-	-	-	-	-	-	■	125	0.18	1.2	-	-	-	-	-	-	☑	20	0.11	0.7

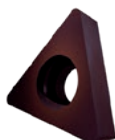

...W es una plaquita plana diseñada para el mecanizado medio de fundición. Presenta un ángulo de desprendimiento neutro sin faceta T. También es condicionalmente adecuada para materiales duros.

TCMW 16T308:T8415	⚙	0.8	-	-	-	-	-	-	■	125	0.18	1.5	-	-	-	-	-	-	☑	20	0.11	0.7
-------------------	---	-----	---	---	---	---	---	---	---	-----	------	-----	---	---	---	---	---	---	---	----	------	-----



...W es una plaquita plana diseñada para el mecanizado medio de fundición. Presenta un ángulo de desprendimiento neutro sin faceta T. También es condicionalmente adecuada para materiales duros.

VCMW 110304:T8415	●	0.4	-	-	-	-	-	-	■	105	0.10	1.2	-	-	-	-	-	-	☑	20	0.10	0.3
VCMW 160404:T8415	●	0.4	-	-	-	-	-	-	■	100	0.10	1.5	-	-	-	-	-	-	☑	15	0.10	0.3
VCMW 160408:T8415	●	0.8	-	-	-	-	-	-	■	100	0.18	1.5	-	-	-	-	-	-	☑	15	0.11	0.7



RM3

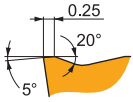

RM3 es un rompevirutas robusto y está diseñado para el desbaste de aceros y fundiciones. Se caracteriza por un ángulo de desprendimiento positivo y una faceta T negativa y ancha. También es adecuado para aceros inoxidables y materiales duros.



TCMT

	IC (mm)	D1 (mm)	L (mm)	S (mm)
16T3	9.525	4.40	16.50	3.97

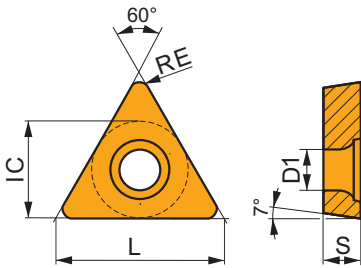

Valores de inicio adecuados para la velocidad de corte (vc), avance (f) y profundidad de corte (ap). Consulte nuestra APP Calculadora de mecanizado para obtener más cálculos.

Producto	Interrupted/ Continuous cut	RE (mm)	P			M			K			N			S			H		
			vc (m/min)	f (mm/rev)	ap (mm)	vc (m/min)	f (mm/rev)	ap (mm)	vc (m/min)	f (mm/rev)	ap (mm)	vc (m/min)	f (mm/rev)	ap (mm)	vc (m/min)	f (mm/rev)	ap (mm)			

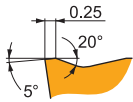
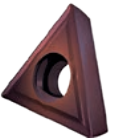

RM3 es un rompevirutas robusto y está diseñado para el desbaste de aceros y fundiciones. Se caracteriza por un ángulo de desprendimiento positivo y una faceta T negativa y ancha. También es adecuado para aceros inoxidables y materiales duros.

TCMT 16T304E-RM3:T8415	●	0.4	■	150	0.20	2.0	☑	75	0.20	2.0	■	135	0.20	2.0	—	—	—	—	—	—	☑	25	0.14	0.3
TCMT 16T308E-RM3:T8415	●	0.8	■	160	0.27	2.0	☑	85	0.27	2.0	■	145	0.27	2.0	—	—	—	—	—	—	☑	25	0.14	0.7

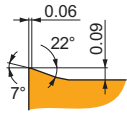
**FF**

FF es un rompevirutas afilado y está diseñado para el acabado fino de aceros y aceros inoxidable. Se caracteriza por un ángulo de desprendimiento positivo y una faceta T positiva y fina. También es condicionalmente adecuado para fundiciones.

**CNMG**

	IC	D1	L	S
	(mm)	(mm)	(mm)	(mm)
1204	12.700	5.16	12.90	4.76

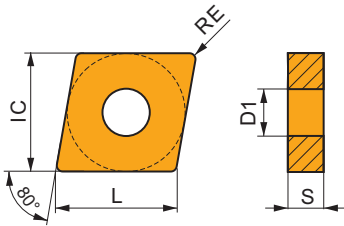
**DNMG**

	IC	D1	L	S
	(mm)	(mm)	(mm)	(mm)
1104	9.525	3.81	11.60	4.76
1506	12.700	5.16	15.50	6.35

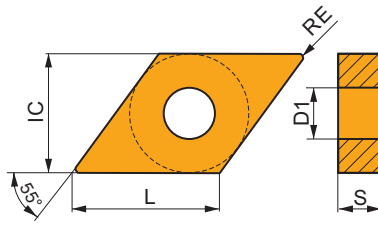
**TNMG**

	IC	D1	L	S
	(mm)	(mm)	(mm)	(mm)
1604	9.525	3.81	16.50	4.76

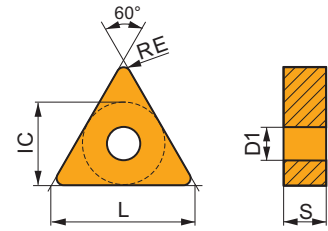
**VNMG**

	IC	D1	L	S
	(mm)	(mm)	(mm)	(mm)
1604	9.525	3.81	16.60	4.76

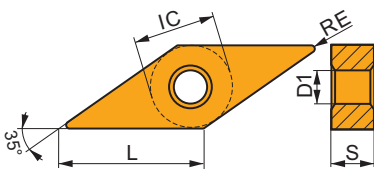
**WNMG**

	IC	D1	L	S
	(mm)	(mm)	(mm)	(mm)
0604	9.525	3.81	6.50	4.76
0804	12.700	5.16	8.70	4.76

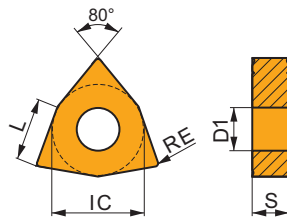



Valores de inicio adecuados para la velocidad de corte (vc), avance (f) y profundidad de corte (ap). Consulte nuestra APP Calculadora de mecanizado para obtener más cálculos.

Producto	Interrupted/ Continuous cut	RE (mm)	P			M			K			N			S			H		
			vc (m/min)	f (mm/rev)	ap (mm)	vc (m/min)	f (mm/rev)	ap (mm)	vc (m/min)	f (mm/rev)	ap (mm)	vc (m/min)	f (mm/rev)	ap (mm)	vc (m/min)	f (mm/rev)	ap (mm)	vc (m/min)	f (mm/rev)	ap (mm)

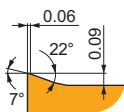
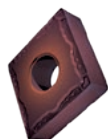

FF es un rompevirutas afilado y está diseñado para el acabado fino de aceros y aceros inoxidables. Se caracteriza por un ángulo de desprendimiento positivo y una faceta T positiva y fina. También es condicionalmente adecuado para fundiciones.

CNMG 120404E-FF:T8415	●	0.4	260	0.12	1.0	135	0.11	1.0	240	0.12	1.0	-	-	-	-	-	-	-	-
CNMG 120408E-FF:T8415	●	0.8	300	0.15	1.0	155	0.14	1.0	270	0.15	1.0	-	-	-	-	-	-	-	-

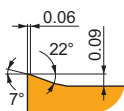

FF es un rompevirutas afilado y está diseñado para el acabado fino de aceros y aceros inoxidables. Se caracteriza por un ángulo de desprendimiento positivo y una faceta T positiva y fina. También es condicionalmente adecuado para fundiciones.

DNMG 110402E-FF:T8415	●	0.4	215	0.10	0.8	110	0.09	0.8	195	0.10	0.8	-	-	-	-	-	-	-	-
DNMG 110404E-FF:T8415	●	0.4	215	0.12	0.8	110	0.11	0.8	195	0.12	0.8	-	-	-	-	-	-	-	-
DNMG 110408E-FF:T8415	●	0.4	240	0.15	0.8	125	0.14	0.8	215	0.15	0.8	-	-	-	-	-	-	-	-
DNMG 150604E-FF:T8415	●	0.8	210	0.12	1.0	110	0.11	1.0	190	0.12	1.0	-	-	-	-	-	-	-	-
DNMG 150608E-FF:T8415	●	0.8	240	0.15	1.0	125	0.14	1.0	215	0.15	1.0	-	-	-	-	-	-	-	-

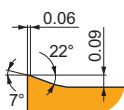
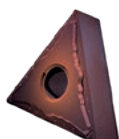

FF es un rompevirutas afilado y está diseñado para el acabado fino de aceros y aceros inoxidables. Se caracteriza por un ángulo de desprendimiento positivo y una faceta T positiva y fina. También es condicionalmente adecuado para fundiciones.

TNMG 160404E-FF:T8415	●	0.4	225	0.12	1.0	115	0.11	1.0	205	0.12	1.0	-	-	-	-	-	-	-	-
TNMG 160408E-FF:T8415	●	0.8	250	0.15	1.0	130	0.14	1.0	225	0.15	1.0	-	-	-	-	-	-	-	-

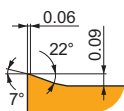

FF es un rompevirutas afilado y está diseñado para el acabado fino de aceros y aceros inoxidables. Se caracteriza por un ángulo de desprendimiento positivo y una faceta T positiva y fina. También es condicionalmente adecuado para fundiciones.

VNMG 160404E-FF:T8415	●	0.4	185	0.12	1.0	95	0.11	1.0	165	0.12	1.0	-	-	-	-	-	-	-	-
-----------------------	---	-----	-----	------	-----	----	------	-----	-----	------	-----	---	---	---	---	---	---	---	---

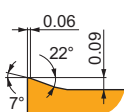
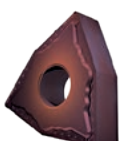

FF es un rompevirutas afilado y está diseñado para el acabado fino de aceros y aceros inoxidables. Se caracteriza por un ángulo de desprendimiento positivo y una faceta T positiva y fina. También es condicionalmente adecuado para fundiciones.

WNMG 060402E-FF:T8415	●	0.2	260	0.10	1.0	135	0.09	1.0	240	0.10	1.0	-	-	-	-	-	-	-	-
WNMG 060404E-FF:T8415	●	0.4	260	0.12	1.0	135	0.11	1.0	240	0.12	1.0	-	-	-	-	-	-	-	-
WNMG 080404E-FF:T8415	●	0.4	260	0.12	1.0	135	0.11	1.0	240	0.12	1.0	-	-	-	-	-	-	-	-
WNMG 080408E-FF:T8415	●	0.8	300	0.15	1.0	155	0.14	1.0	270	0.15	1.0	-	-	-	-	-	-	-	-



FM

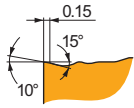

FM es un rompevirutas versátil y la primera elección para el acabado de aceros y fundiciones. Presenta un ángulo de desprendimiento ligeramente positivo y una faceta T positiva y estrecha. También es adecuado para aceros inoxidables y superaleaciones.



CNMG

	IC	D1	L	S
	(mm)	(mm)	(mm)	(mm)
1204	12.700	5.16	12.90	4.76

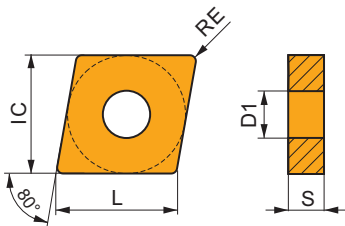

DNMG

	IC	D1	L	S
	(mm)	(mm)	(mm)	(mm)
1104	9.525	3.81	11.60	4.76
1506	12.700	5.16	15.50	6.35

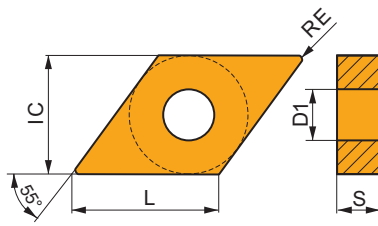

SNMG

	IC	D1	L	S
	(mm)	(mm)	(mm)	(mm)
1204	12.700	5.16	12.70	4.76

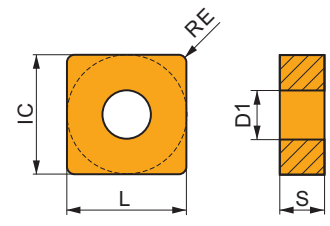

TNMG

	IC	D1	L	S
	(mm)	(mm)	(mm)	(mm)
1604	9.525	3.81	16.50	4.76

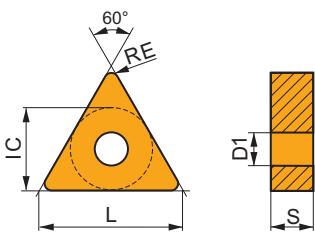

WNMG

	IC	D1	L	S
	(mm)	(mm)	(mm)	(mm)
0604	9.525	3.81	6.50	4.76
0804	12.700	5.16	8.70	4.76

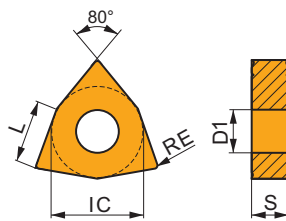



Valores de inicio adecuados para la velocidad de corte (vc), avance (f) y profundidad de corte (ap). Consulte nuestra APP Calculadora de mecanizado para obtener más cálculos.

Producto	Interrupted/ Continuous cut	RE (mm)	P			M			K			N			S			H		
			vc (m/min)	f (mm/rev)	ap (mm)	vc (m/min)	f (mm/rev)	ap (mm)	vc (m/min)	f (mm/rev)	ap (mm)	vc (m/min)	f (mm/rev)	ap (mm)	vc (m/min)	f (mm/rev)	ap (mm)	vc (m/min)	f (mm/rev)	ap (mm)

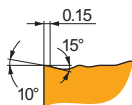
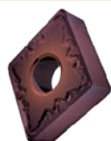

FM es un rompevirutas versátil y la primera elección para el acabado de aceros y fundiciones. Presenta un ángulo de desprendimiento ligeramente positivo y una faceta T positiva y estrecha. También es adecuado para aceros inoxidables y superaleaciones.

CNMG 120404E-FM:T8415	●	0.4	215	0.20	2.1	110	0.18	2.1	195	0.20	2.1	–	–	–	45	0.14	1.7	–	–	–
CNMG 120408E-FM:T8415	⚙	0.8	250	0.20	2.1	130	0.18	2.1	225	0.20	2.1	–	–	–	55	0.16	1.7	–	–	–

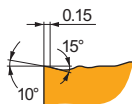

FM es un rompevirutas versátil y la primera elección para el acabado de aceros y fundiciones. Presenta un ángulo de desprendimiento ligeramente positivo y una faceta T positiva y estrecha. También es adecuado para aceros inoxidables y superaleaciones.

DNMG 110404E-FM:T8415	●	0.4	185	0.20	0.8	95	0.18	0.8	165	0.20	0.8	–	–	–	40	0.14	0.6	–	–	–
DNMG 110408E-FM:T8415	●	0.8	220	0.20	0.8	115	0.18	0.8	200	0.20	0.8	–	–	–	50	0.14	0.6	–	–	–
DNMG 150604E-FM:T8415	●	0.4	170	0.20	1.7	90	0.18	1.7	155	0.20	1.7	–	–	–	35	0.14	1.4	–	–	–
DNMG 150608E-FM:T8415	●	0.8	210	0.20	1.7	110	0.18	1.7	190	0.20	1.7	–	–	–	45	0.16	1.4	–	–	–

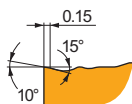
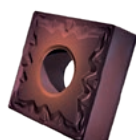

FM es un rompevirutas versátil y la primera elección para el acabado de aceros y fundiciones. Presenta un ángulo de desprendimiento ligeramente positivo y una faceta T positiva y estrecha. También es adecuado para aceros inoxidables y superaleaciones.

SNMG 120404E-FM:T8415	●	0.4	220	0.20	2.1	115	0.18	2.1	200	0.20	2.1	–	–	–	50	0.14	1.7	–	–	–
SNMG 120408E-FM:T8415	⚙	0.8	260	0.20	2.1	135	0.18	2.1	240	0.20	2.1	–	–	–	60	0.16	1.7	–	–	–

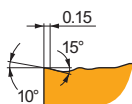
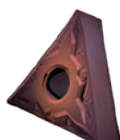

FM es un rompevirutas versátil y la primera elección para el acabado de aceros y fundiciones. Presenta un ángulo de desprendimiento ligeramente positivo y una faceta T positiva y estrecha. También es adecuado para aceros inoxidables y superaleaciones.

TNMG 160404E-FM:T8415	●	0.4	185	0.20	1.7	95	0.18	1.7	165	0.20	1.7	–	–	–	40	0.14	1.4	–	–	–
TNMG 160408E-FM:T8415	●	0.8	220	0.20	1.7	115	0.18	1.7	200	0.20	1.7	–	–	–	50	0.16	1.4	–	–	–

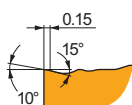
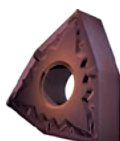

FM es un rompevirutas versátil y la primera elección para el acabado de aceros y fundiciones. Presenta un ángulo de desprendimiento ligeramente positivo y una faceta T positiva y estrecha. También es adecuado para aceros inoxidables y superaleaciones.

WNMG 060404E-FM:T8415	●	0.4	220	0.20	1.4	115	0.18	1.4	200	0.20	1.4	–	–	–	50	0.14	1.1	–	–	–
WNMG 080404E-FM:T8415	●	0.4	215	0.20	1.9	110	0.18	1.9	195	0.20	1.9	–	–	–	45	0.14	1.5	–	–	–
WNMG 080408E-FM:T8415	⚙	0.8	250	0.20	1.9	130	0.18	1.9	225	0.20	1.9	–	–	–	55	0.16	1.5	–	–	–

● Adecuado para condiciones de trabajo estables ⚙ Adecuado para condiciones de trabajo inestables ⚙ Adecuado para condiciones de trabajo duras ■ Uso principal ▣ Uso posible



SF

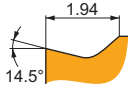

SF es un rompevirutas afilado y la primera elección para el acabado de aceros inoxidables y superaleaciones. Presenta un ángulo de desprendimiento ligeramente positivo sin faceta T. También es adecuado para aceros, fundiciones, materiales duros y, condicionalmente, para aleaciones no férrreas.



CNGG

	IC	D1	L	S
	(mm)	(mm)	(mm)	(mm)
1204	12.700	5.16	12.90	4.76

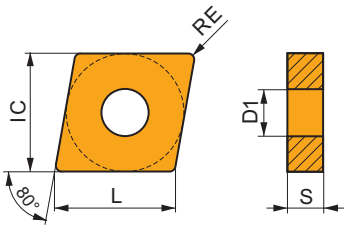

CNMG

	IC	D1	L	S
	(mm)	(mm)	(mm)	(mm)
1204	12.700	5.16	12.90	4.76

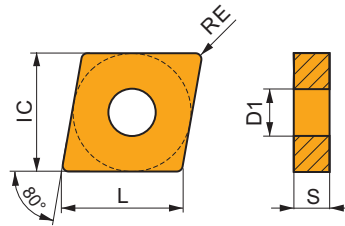

DNMG

	IC	D1	L	S
	(mm)	(mm)	(mm)	(mm)
1104	9.525	3.81	11.60	4.76
1504	12.700	5.16	15.50	4.76
1506	12.700	5.16	15.50	6.35

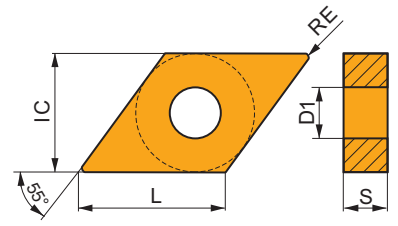

SNMG

	IC	D1	L	S
	(mm)	(mm)	(mm)	(mm)
1204	12.700	5.16	12.70	4.76

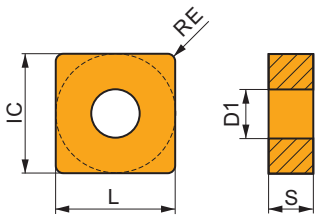

TNMG

	IC	D1	L	S
	(mm)	(mm)	(mm)	(mm)
1604	9.525	3.81	16.50	4.76
2204	12.700	5.16	22.00	4.76

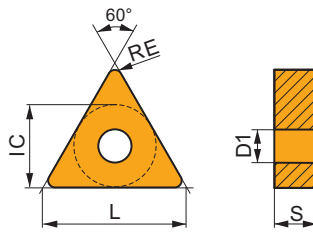

VNMG

	IC	D1	L	S
	(mm)	(mm)	(mm)	(mm)
1604	9.525	3.81	16.60	4.76

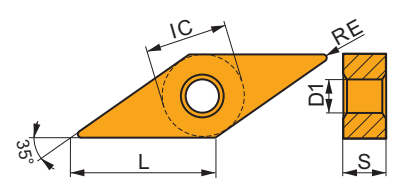

WNMG

	IC	D1	L	S
	(mm)	(mm)	(mm)	(mm)
0604	9.525	3.81	6.50	4.76
0804	12.700	5.16	8.70	4.76

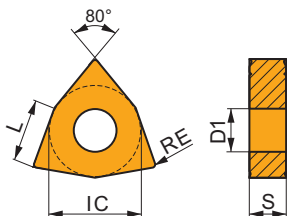



Valores de inicio adecuados para la velocidad de corte (vc), avance (f) y profundidad de corte (ap). Consulte nuestra APP Calculadora de mecanizado para obtener más cálculos.

Producto	Interrupted/ Continuous cut	RE (mm)	P			M			K			N			S			H		
			vc (m/min)	f (mm/rev)	ap (mm)	vc (m/min)	f (mm/rev)	ap (mm)	vc (m/min)	f (mm/rev)	ap (mm)	vc (m/min)	f (mm/rev)	ap (mm)	vc (m/min)	f (mm/rev)	ap (mm)	vc (m/min)	f (mm/rev)	ap (mm)

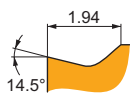
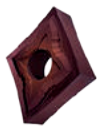

SF es un rompevirutas afilado y la primera elección para el acabado de aceros inoxidables y superaleaciones. Presenta un ángulo de desprendimiento ligeramente positivo sin faceta T. También es adecuado para aceros, fundiciones, materiales duros y, condicionalmente, para aleaciones no férricas.

CNGG 120402E-SF:T8415	●	0.2	250	0.10	1.0	130	0.09	1.0	225	0.10	1.0	630	0.12	1.0	55	0.08	0.8	40	0.10	0.2
------------------------------	---	-----	-----	------	-----	-----	------	-----	-----	------	-----	-----	------	-----	----	------	-----	----	------	-----

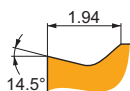
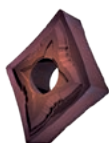

SF es un rompevirutas afilado y la primera elección para el acabado de aceros inoxidables y superaleaciones. Presenta un ángulo de desprendimiento ligeramente positivo sin faceta T. También es adecuado para aceros, fundiciones, materiales duros y, condicionalmente, para aleaciones no férricas.

CNMG 120404E-SF:T8415	●	0.4	240	0.15	1.0	125	0.14	1.0	215	0.15	1.0	600	0.18	1.0	55	0.12	0.8	40	0.10	0.3
CNMG 120408E-SF:T8415	⊕	0.8	255	0.20	1.0	135	0.18	1.0	230	0.20	1.0	645	0.24	1.0	55	0.14	0.8	45	0.10	0.7
CNMG 120412E-SF:T8415	⊕	1.2	250	0.25	1.5	130	0.23	1.5	225	0.25	1.5	630	0.30	1.5	55	0.17	1.2	40	0.13	1.0

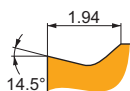

SF es un rompevirutas afilado y la primera elección para el acabado de aceros inoxidables y superaleaciones. Presenta un ángulo de desprendimiento ligeramente positivo sin faceta T. También es adecuado para aceros, fundiciones, materiales duros y, condicionalmente, para aleaciones no férricas.

DNMG 110404E-SF:T8415	●	0.4	190	0.15	0.8	100	0.14	0.8	170	0.15	0.8	480	0.18	0.8	40	0.12	0.6	30	0.10	0.3
DNMG 110408E-SF:T8415	●	0.8	220	0.17	0.8	115	0.15	0.8	200	0.17	0.8	555	0.20	0.8	50	0.14	0.6	35	0.11	0.7
DNMG 150404E-SF:T8415	●	0.4	180	0.15	1.5	90	0.14	1.5	160	0.15	1.5	450	0.18	1.5	40	0.12	1.2	30	0.10	0.3
DNMG 150408E-SF:T8415	●	0.8	210	0.17	1.5	110	0.15	1.5	190	0.17	1.5	525	0.20	1.5	45	0.14	1.2	35	0.11	0.7
DNMG 150604E-SF:T8415	●	0.4	180	0.15	1.5	90	0.14	1.5	160	0.15	1.5	450	0.18	1.5	40	0.12	1.2	30	0.10	0.3
DNMG 150608E-SF:T8415	●	0.8	210	0.17	1.5	110	0.15	1.5	190	0.17	1.5	525	0.20	1.5	45	0.14	1.2	35	0.11	0.7
DNMG 150612E-SF:T8415	⊕	1.2	195	0.25	1.5	100	0.23	1.5	180	0.25	1.5	495	0.30	1.5	45	0.17	1.2	30	0.13	0.9

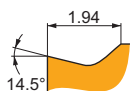
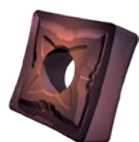

SF es un rompevirutas afilado y la primera elección para el acabado de aceros inoxidables y superaleaciones. Presenta un ángulo de desprendimiento ligeramente positivo sin faceta T. También es adecuado para aceros, fundiciones, materiales duros y, condicionalmente, para aleaciones no férricas.

SNMG 120408E-SF:T8415	⊕	0.8	275	0.20	1.0	140	0.18	1.0	250	0.20	1.0	690	0.24	1.0	60	0.14	0.8	45	0.10	0.7
SNMG 120412E-SF:T8415	⊕	1.2	260	0.25	1.5	135	0.23	1.5	240	0.25	1.5	660	0.30	1.5	60	0.17	1.2	45	0.13	1.0

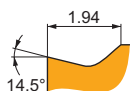

SF es un rompevirutas afilado y la primera elección para el acabado de aceros inoxidables y superaleaciones. Presenta un ángulo de desprendimiento ligeramente positivo sin faceta T. También es adecuado para aceros, fundiciones, materiales duros y, condicionalmente, para aleaciones no férricas.

TNMG 160404E-SF:T8415	●	0.4	195	0.15	1.3	100	0.14	1.3	180	0.15	1.3	495	0.18	1.3	45	0.12	1.0	30	0.10	0.3
TNMG 160408E-SF:T8415	●	0.8	225	0.17	1.3	115	0.15	1.3	205	0.17	1.3	570	0.20	1.3	50	0.14	1.0	35	0.11	0.7
TNMG 160412E-SF:T8415	⊕	1.2	210	0.25	1.5	110	0.23	1.5	190	0.25	1.5	525	0.30	1.5	45	0.17	1.2	35	0.13	0.9
TNMG 220404E-SF:T8415	●	0.4	185	0.17	1.7	95	0.15	1.7	165	0.17	1.7	465	0.20	1.7	40	0.15	1.4	30	0.12	0.3
TNMG 220408E-SF:T8415	●	0.8	220	0.17	1.7	115	0.15	1.7	200	0.17	1.7	555	0.20	1.7	50	0.15	1.4	35	0.12	0.7
TNMG 220412E-SF:T8415	⊕	1.2	195	0.30	1.7	100	0.27	1.7	180	0.30	1.7	495	0.36	1.7	45	0.21	1.4	30	0.15	0.9

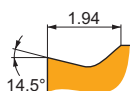

SF es un rompevirutas afilado y la primera elección para el acabado de aceros inoxidables y superaleaciones. Presenta un ángulo de desprendimiento ligeramente positivo sin faceta T. También es adecuado para aceros, fundiciones, materiales duros y, condicionalmente, para aleaciones no férricas.

VNMG 160404E-SF:T8415	●	0.4	160	0.15	1.2	85	0.14	1.2	145	0.15	1.2	405	0.18	1.2	35	0.14	1.0	25	0.15	0.3
VNMG 160408E-SF:T8415	●	0.8	185	0.17	1.4	95	0.15	1.4	165	0.17	1.4	465	0.20	1.4	40	0.14	1.1	30	0.11	0.7

● Adecuado para condiciones de trabajo estables ⊕ Adecuado para condiciones de trabajo inestables ⊕ Adecuado para condiciones de trabajo duras ■ Uso principal ☑ Uso posible



Valores de inicio adecuados para la velocidad de corte (vc), avance (f) y profundidad de corte (ap). Consulte nuestra APP Calculadora de mecanizado para obtener más cálculos.

Producto	Interrupted/ Continuous cut	RE (mm)	P			M			K			N			S			H		
			vc (m/min)	f (mm/rev)	ap (mm)	vc (m/min)	f (mm/rev)	ap (mm)	vc (m/min)	f (mm/rev)	ap (mm)	vc (m/min)	f (mm/rev)	ap (mm)	vc (m/min)	f (mm/rev)	ap (mm)	vc (m/min)	f (mm/rev)	ap (mm)

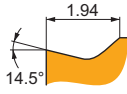

SF es un rompevirutas afilado y la primera elección para el acabado de aceros inoxidable y superaleaciones. Presenta un ángulo de desprendimiento ligeramente positivo sin faceta T. También es adecuado para aceros, fundiciones, materiales duros y, condicionalmente, para aleaciones no férricas.

WNMG 060404E-SF:T8415	●	0.4	■	240	0.15	1.0	■	125	0.14	1.0	■	215	0.15	1.0	▣	600	0.18	1.0	■	55	0.12	0.8	■	40	0.10	0.3
WNMG 060408E-SF:T8415	⊕	0.8	■	255	0.20	1.0	■	135	0.18	1.0	■	230	0.20	1.0	▣	645	0.24	1.0	■	55	0.14	0.8	■	45	0.10	0.7
WNMG 080404E-SF:T8415	●	0.4	■	240	0.15	1.0	■	125	0.14	1.0	■	215	0.15	1.0	▣	600	0.18	1.0	■	55	0.12	0.8	■	40	0.10	0.3
WNMG 080408E-SF:T8415	⊕	0.8	■	255	0.20	1.0	■	135	0.18	1.0	■	230	0.20	1.0	▣	645	0.24	1.0	■	55	0.14	0.8	■	45	0.10	0.7



SM

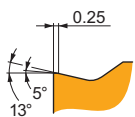

SM es un rompevirutas versátil y la primera elección para el mecanizado medio de aceros y superaleaciones. Se caracteriza por un ángulo de desprendimiento ligeramente positivo y una faceta T estable y moderada. También es adecuado para aceros inoxidables, fundiciones y, condicionalmente, para aleaciones no férricas y materiales duros.



CNMG

	IC (mm)	D1 (mm)	L (mm)	S (mm)
1204	12.700	5.16	12.90	4.76
1606	15.875	6.35	16.10	6.35
1906	19.050	7.94	19.30	6.35

DNMG

	IC (mm)	D1 (mm)	L (mm)	S (mm)
1104	9.525	3.81	11.60	4.76
1504	12.700	5.16	15.50	4.76
1506	12.700	5.16	15.50	6.35

SNMG

	IC (mm)	D1 (mm)	L (mm)	S (mm)
1204	12.700	5.16	12.70	4.76
1906	19.050	7.94	19.05	6.35

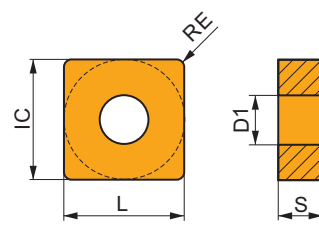
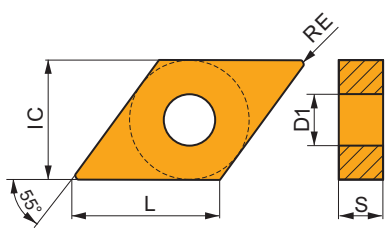
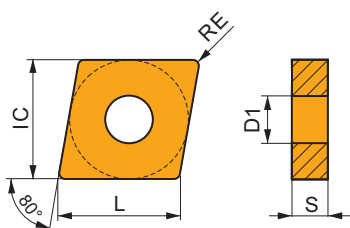

TNMG

	IC (mm)	D1 (mm)	L (mm)	S (mm)
1604	9.525	3.81	16.50	4.76
2204	12.700	5.16	22.00	4.76

VNMG

	IC (mm)	D1 (mm)	L (mm)	S (mm)
1604	9.525	3.81	16.60	4.76

WNMG

	IC (mm)	D1 (mm)	L (mm)	S (mm)
0604	9.525	3.81	6.50	4.76
0804	12.700	5.16	8.70	4.76

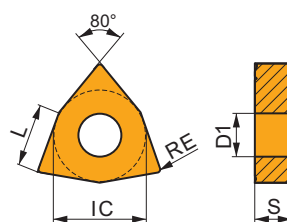
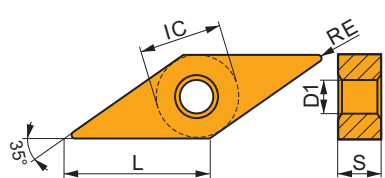
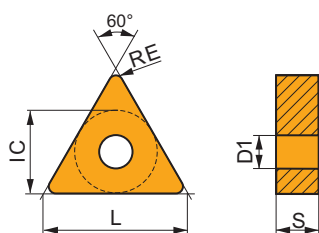

Valores de inicio adecuados para la velocidad de corte (vc), avance (f) y profundidad de corte (ap). Consulte nuestra APP Calculadora de mecanizado para obtener más cálculos.

Producto	RE (mm)	P			M			K			N			S			H		
		vc (m/min)	f (mm/rev)	ap (mm)	vc (m/min)	f (mm/rev)	ap (mm)	vc (m/min)	f (mm/rev)	ap (mm)	vc (m/min)	f (mm/rev)	ap (mm)	vc (m/min)	f (mm/rev)	ap (mm)	vc (m/min)	f (mm/rev)	ap (mm)

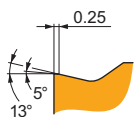

SM es un rompevirutas versátil y la primera elección para el mecanizado medio de aceros y superaleaciones. Se caracteriza por un ángulo de desprendimiento ligeramente positivo y una faceta T estable y moderada. También es adecuado para aceros inoxidables, fundiciones y, condicionalmente, para aleaciones no férricas y materiales duros.

CNMG 120404E-SM:T8415	● 0.4	■ 200	■ 0.20	■ 2.0	■ 105	■ 0.18	■ 2.0	■ 185	■ 0.20	■ 2.0	■ 510	■ 0.24	■ 2.0	■ 45	■ 0.18	■ 1.6	■ 35	■ 0.13	■ 0.3
CNMG 120408E-SM:T8415	● 0.8	■ 225	■ 0.25	■ 2.0	■ 115	■ 0.23	■ 2.0	■ 205	■ 0.25	■ 2.0	■ 570	■ 0.30	■ 2.0	■ 50	■ 0.20	■ 1.6	■ 35	■ 0.13	■ 0.7
CNMG 120412E-SM:T8415	● 1.2	■ 225	■ 0.30	■ 2.0	■ 115	■ 0.27	■ 2.0	■ 205	■ 0.30	■ 2.0	■ 570	■ 0.36	■ 2.0	■ 50	■ 0.24	■ 1.6	■ 35	■ 0.15	■ 1.0
CNMG 160612E-SM:T8415	● 1.2	■ 215	■ 0.30	■ 3.0	■ 110	■ 0.27	■ 3.0	■ 195	■ 0.30	■ 3.0	■ 540	■ 0.36	■ 3.0	■ 45	■ 0.27	■ 2.4	■ 35	■ 0.15	■ 1.0
CNMG 190612E-SM:T8415	● 1.2	■ 210	■ 0.30	■ 4.0	■ 110	■ 0.27	■ 4.0	■ 190	■ 0.30	■ 4.0	■ 525	■ 0.36	■ 4.0	■ 45	■ 0.27	■ 3.2	■ 35	■ 0.15	■ 1.0

● Adecuado para condiciones de trabajo estables ● Adecuado para condiciones de trabajo inestables ● Adecuado para condiciones de trabajo duras ■ Uso principal ■ Uso posible



Valores de inicio adecuados para la velocidad de corte (vc), avance (f) y profundidad de corte (ap). Consulte nuestra APP Calculadora de mecanizado para obtener más cálculos.

Producto	Interrupted/ Continuous cut	RE (mm)	P			M			K			N			S			H		
			vc (m/min)	f (mm/rev)	ap (mm)	vc (m/min)	f (mm/rev)	ap (mm)	vc (m/min)	f (mm/rev)	ap (mm)	vc (m/min)	f (mm/rev)	ap (mm)	vc (m/min)	f (mm/rev)	ap (mm)	vc (m/min)	f (mm/rev)	ap (mm)

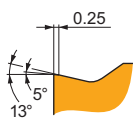

SM es un rompevirutas versátil y la primera elección para el mecanizado medio de aceros y superaleaciones. Se caracteriza por un ángulo de desprendimiento ligeramente positivo y una faceta T estable y moderada. También es adecuado para aceros inoxidables, fundiciones y, condicionalmente, para aleaciones no férricas y materiales duros.

DNMG 110404E-SM:T8415	●	0.4	180	0.20	0.8	90	0.18	0.8	160	0.20	0.8	450	0.24	0.8	40	0.18	0.6	30	0.14	0.3
DNMG 110408E-SM:T8415	●	0.8	190	0.25	1.2	100	0.23	1.2	170	0.25	1.2	480	0.30	1.2	40	0.20	1.0	30	0.13	0.7
DNMG 150404E-SM:T8415	●	0.4	165	0.20	1.7	85	0.18	1.7	150	0.20	1.7	420	0.24	1.7	35	0.18	1.4	25	0.14	0.3
DNMG 150408E-SM:T8415	●	0.8	185	0.25	1.7	95	0.23	1.7	165	0.25	1.7	465	0.30	1.7	40	0.20	1.4	30	0.13	0.7
DNMG 150604E-SM:T8415	●	0.4	165	0.20	1.7	85	0.18	1.7	150	0.20	1.7	420	0.24	1.7	35	0.18	1.4	25	0.14	0.3
DNMG 150608E-SM:T8415	●	0.8	185	0.25	1.7	95	0.23	1.7	165	0.25	1.7	465	0.30	1.7	40	0.20	1.4	30	0.13	0.7
DNMG 150612E-SM:T8415	●	1.2	185	0.30	1.7	95	0.27	1.7	165	0.30	1.7	465	0.36	1.7	40	0.24	1.4	30	0.15	0.9

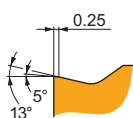
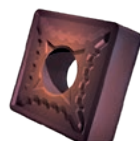

SM es un rompevirutas versátil y la primera elección para el mecanizado medio de aceros y superaleaciones. Se caracteriza por un ángulo de desprendimiento ligeramente positivo y una faceta T estable y moderada. También es adecuado para aceros inoxidables, fundiciones y, condicionalmente, para aleaciones no férricas y materiales duros.

SNMG 120408E-SM:T8415	●	0.8	240	0.25	1.8	125	0.23	1.8	215	0.25	1.8	600	0.30	1.8	55	0.20	1.4	40	0.13	0.7
SNMG 190612E-SM:T8415	●	1.2	220	0.30	4.0	115	0.27	4.0	200	0.30	4.0	555	0.36	4.0	50	0.27	3.2	35	0.15	1.0

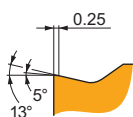

SM es un rompevirutas versátil y la primera elección para el mecanizado medio de aceros y superaleaciones. Se caracteriza por un ángulo de desprendimiento ligeramente positivo y una faceta T estable y moderada. También es adecuado para aceros inoxidables, fundiciones y, condicionalmente, para aleaciones no férricas y materiales duros.

TNMG 160404E-SM:T8415	●	0.4	170	0.20	1.7	90	0.18	1.7	155	0.20	1.7	435	0.24	1.7	35	0.18	1.4	30	0.14	0.3
TNMG 160408E-SM:T8415	●	0.8	195	0.25	1.7	100	0.23	1.7	180	0.25	1.7	495	0.30	1.7	45	0.20	1.4	30	0.13	0.7
TNMG 160412E-SM:T8415	●	1.2	195	0.30	1.7	100	0.27	1.7	180	0.30	1.7	495	0.36	1.7	45	0.24	1.4	30	0.15	0.9
TNMG 220404E-SM:T8415	●	0.4	170	0.20	1.7	90	0.18	1.7	155	0.20	1.7	435	0.24	1.7	35	0.18	1.4	30	0.14	0.3
TNMG 220408E-SM:T8415	●	0.8	195	0.25	1.7	100	0.23	1.7	180	0.25	1.7	495	0.30	1.7	45	0.20	1.4	30	0.13	0.7
TNMG 220412E-SM:T8415	●	1.2	195	0.30	1.7	100	0.27	1.7	180	0.30	1.7	495	0.36	1.7	45	0.24	1.4	30	0.15	0.9

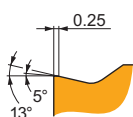

SM es un rompevirutas versátil y la primera elección para el mecanizado medio de aceros y superaleaciones. Se caracteriza por un ángulo de desprendimiento ligeramente positivo y una faceta T estable y moderada. También es adecuado para aceros inoxidables, fundiciones y, condicionalmente, para aleaciones no férricas y materiales duros.

VNMG 160404E-SM:T8415	●	0.4	155	0.18	1.2	80	0.16	1.2	140	0.18	1.2	390	0.22	1.2	35	0.16	1.0	25	0.13	0.3
VNMG 160408E-SM:T8415	●	0.8	160	0.25	1.4	85	0.23	1.4	145	0.25	1.4	405	0.30	1.4	35	0.20	1.1	25	0.13	0.7

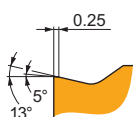
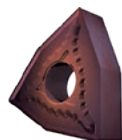

SM es un rompevirutas versátil y la primera elección para el mecanizado medio de aceros y superaleaciones. Se caracteriza por un ángulo de desprendimiento ligeramente positivo y una faceta T estable y moderada. También es adecuado para aceros inoxidables, fundiciones y, condicionalmente, para aleaciones no férricas y materiales duros.

WNMG 060408E-SM:T8415	●	0.8	225	0.25	1.7	115	0.23	1.7	205	0.25	1.7	570	0.30	1.7	50	0.20	1.4	35	0.13	0.7
WNMG 080404E-SM:T8415	●	0.4	200	0.20	2.0	105	0.18	2.0	185	0.20	2.0	510	0.24	2.0	45	0.18	1.6	35	0.13	0.3
WNMG 080408E-SM:T8415	●	0.8	225	0.25	2.0	115	0.23	2.0	205	0.25	2.0	570	0.30	2.0	50	0.20	1.6	35	0.13	0.7
WNMG 080412E-SM:T8415	●	1.2	225	0.30	2.0	115	0.27	2.0	205	0.30	2.0	570	0.36	2.0	50	0.24	1.6	35	0.15	1.0



SI

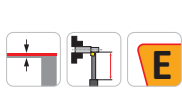
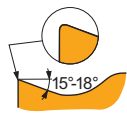

SI es un rompevirutas afilado y está diseñado para el mecanizado medio de aceros y aceros inoxidables. Presenta un ángulo de desprendimiento positivo sin faceta T. También es adecuado para aleaciones no férricas y superaleaciones.



DNMG

IC	D1	L	S
(mm)	(mm)	(mm)	(mm)
1506	12.700	5.16	6.35

TNMG

IC	D1	L	S
(mm)	(mm)	(mm)	(mm)
1604	9.525	3.81	4.76

WNMG

IC	D1	L	S
(mm)	(mm)	(mm)	(mm)
0804	12.700	5.16	4.76

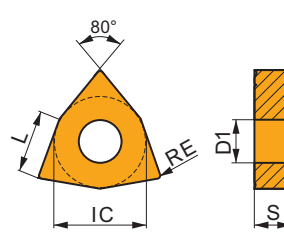
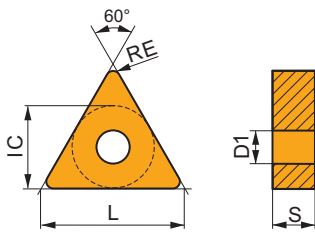
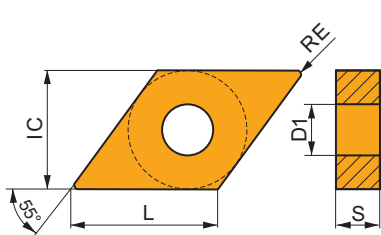

Valores de inicio adecuados para la velocidad de corte (vc), avance (f) y profundidad de corte (ap). Consulte nuestra APP Calculadora de mecanizado para obtener más cálculos.

Producto	Interrupted/ Continuous cut	RE (mm)	P			M			K			N			S			H		
			vc (m/min)	f (mm/rev)	ap (mm)	vc (m/min)	f (mm/rev)	ap (mm)	vc (m/min)	f (mm/rev)	ap (mm)	vc (m/min)	f (mm/rev)	ap (mm)	vc (m/min)	f (mm/rev)	ap (mm)	vc (m/min)	f (mm/rev)	ap (mm)

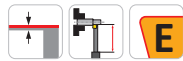
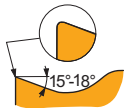
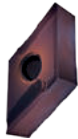

SI es un rompevirutas afilado y está diseñado para el mecanizado medio de aceros y aceros inoxidables. Presenta un ángulo de desprendimiento positivo sin faceta T. También es adecuado para aleaciones no férricas y superaleaciones.

DNMG 150604ER-SI-T8415	●	0.4	195	0.20	1.5	100	0.18	1.5	–	–	–	495	0.24	1.5	45	0.18	1.2	–	–	–
DNMG 150608ER-SI-T8415	●	0.8	200	0.35	1.5	105	0.32	1.5	–	–	–	510	0.42	1.5	45	0.24	1.2	–	–	–

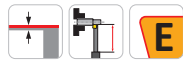
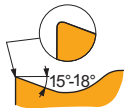
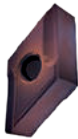

SI es un rompevirutas afilado y está diseñado para el mecanizado medio de aceros y aceros inoxidables. Presenta un ángulo de desprendimiento positivo sin faceta T. También es adecuado para aleaciones no férricas y superaleaciones.

DNMG 150608EL-SI-T8415	●	0.8	200	0.35	1.5	105	0.32	1.5	–	–	–	510	0.42	1.5	45	0.24	1.2	–	–	–
------------------------	---	-----	-----	------	-----	-----	------	-----	---	---	---	-----	------	-----	----	------	-----	---	---	---

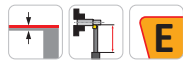
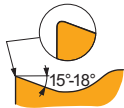
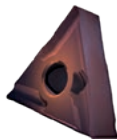

SI es un rompevirutas afilado y está diseñado para el mecanizado medio de aceros y aceros inoxidables. Presenta un ángulo de desprendimiento positivo sin faceta T. También es adecuado para aleaciones no férricas y superaleaciones.

TNMG 160404ER-SI-T8415	●	0.4	210	0.20	1.5	110	0.18	1.5	–	–	–	525	0.24	1.5	45	0.18	1.2	–	–	–
TNMG 160408ER-SI-T8415	●	0.8	215	0.35	1.5	110	0.32	1.5	–	–	–	540	0.42	1.5	45	0.24	1.2	–	–	–

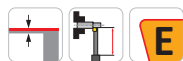
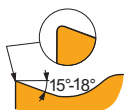
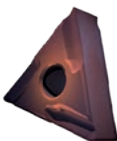

SI es un rompevirutas afilado y está diseñado para el mecanizado medio de aceros y aceros inoxidables. Presenta un ángulo de desprendimiento positivo sin faceta T. También es adecuado para aleaciones no férricas y superaleaciones.

TNMG 160404EL-SI-T8415	●	0.4	210	0.20	1.5	110	0.18	1.5	–	–	–	525	0.24	1.5	45	0.18	1.2	–	–	–
TNMG 160408EL-SI-T8415	●	0.8	215	0.35	1.5	110	0.32	1.5	–	–	–	540	0.42	1.5	45	0.24	1.2	–	–	–

● Adecuado para condiciones de trabajo estables ● Adecuado para condiciones de trabajo inestables ✦ Adecuado para condiciones de trabajo duras ■ Uso principal ☑ Uso posible



Valores de inicio adecuados para la velocidad de corte (vc), avance (f) y profundidad de corte (ap). Consulte nuestra APP Calculadora de mecanizado para obtener más cálculos.

Producto	Interrupted/ Continuous cut	RE (mm)	P			M			K			N			S			H		
			vc (m/min)	f (mm/rev)	ap (mm)	vc (m/min)	f (mm/rev)	ap (mm)	vc (m/min)	f (mm/rev)	ap (mm)	vc (m/min)	f (mm/rev)	ap (mm)	vc (m/min)	f (mm/rev)	ap (mm)	vc (m/min)	f (mm/rev)	ap (mm)

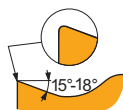
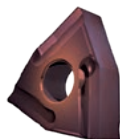

SI es un rompevirutas afilado y está diseñado para el mecanizado medio de aceros y aceros inoxidable. Presenta un ángulo de desprendimiento positivo sin faceta T. También es adecuado para aleaciones no férricas y superaleaciones.

WNMG 080404ER-SI:T8415	●	0.4	■	250	0.20	1.7	■	130	0.18	1.7	■	-	-	-	☒	630	0.24	1.7	☒	55	0.18	1.4	■	-	-	-
-------------------------------	---	-----	---	-----	------	-----	---	-----	------	-----	---	---	---	---	---	-----	------	-----	---	----	------	-----	---	---	---	---

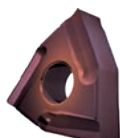

SI es un rompevirutas afilado y está diseñado para el mecanizado medio de aceros y aceros inoxidable. Presenta un ángulo de desprendimiento positivo sin faceta T. También es adecuado para aleaciones no férricas y superaleaciones.

WNMG 080404EL-SI:T8415	●	0.4	■	250	0.20	1.7	■	130	0.18	1.7	■	-	-	-	☒	630	0.24	1.7	☒	55	0.18	1.4	■	-	-	-
-------------------------------	---	-----	---	-----	------	-----	---	-----	------	-----	---	---	---	---	---	-----	------	-----	---	----	------	-----	---	---	---	---



NM

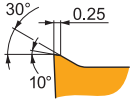

NM es un rompevirutas afilado y está diseñado para el mecanizado medio de aceros, aceros inoxidables y superaleaciones. Se caracteriza por un ángulo de desprendimiento muy positivo y una faceta T positiva y moderada. También es condicionalmente adecuado para aleaciones no férricas.



CNMG

	IC	D1	L	S
	(mm)	(mm)	(mm)	(mm)
1204	12.700	5.16	12.90	4.76

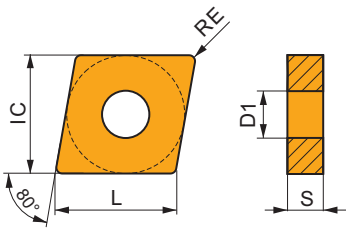

DNMG

	IC	D1	L	S
	(mm)	(mm)	(mm)	(mm)
1104	9.525	3.81	11.60	4.76

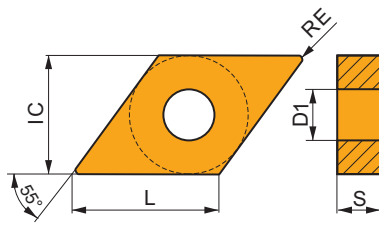

TNMG

	IC	D1	L	S
	(mm)	(mm)	(mm)	(mm)
1604	9.525	3.81	16.50	4.76
2204	12.700	5.16	22.00	4.76

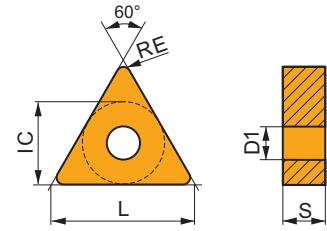

VNMG

	IC	D1	L	S
	(mm)	(mm)	(mm)	(mm)
1604	9.525	3.81	16.60	4.76

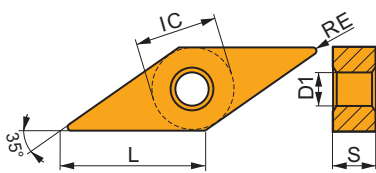

WNMG

	IC	D1	L	S
	(mm)	(mm)	(mm)	(mm)
0804	12.700	5.16	8.70	4.76

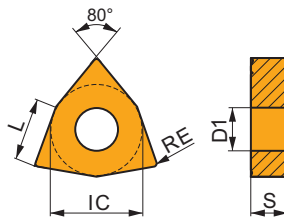



Valores de inicio adecuados para la velocidad de corte (vc), avance (f) y profundidad de corte (ap). Consulte nuestra APP Calculadora de mecanizado para obtener más cálculos.

Producto	Interrupted/ Continuous cut	RE (mm)	P			M			K			N			S			H		
			vc (m/min)	f (mm/rev)	ap (mm)	vc (m/min)	f (mm/rev)	ap (mm)	vc (m/min)	f (mm/rev)	ap (mm)	vc (m/min)	f (mm/rev)	ap (mm)	vc (m/min)	f (mm/rev)	ap (mm)	vc (m/min)	f (mm/rev)	ap (mm)

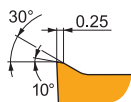
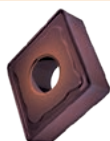

NM es un rompevirutas afilado y está diseñado para el mecanizado medio de aceros, aceros inoxidable y superaleaciones. Se caracteriza por un ángulo de desprendimiento muy positivo y una faceta T positiva y moderada. También es condicionalmente adecuado para aleaciones no férricas.

CNMG 120408E-NM:T8415	⚙️	0.8	245	0.25	2.1	125	0.23	2.1	–	–	–	615	0.30	2.1	55	0.20	1.7	–	–	–
-----------------------	----	-----	-----	------	-----	-----	------	-----	---	---	---	-----	------	-----	----	------	-----	---	---	---

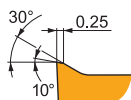

NM es un rompevirutas afilado y está diseñado para el mecanizado medio de aceros, aceros inoxidable y superaleaciones. Se caracteriza por un ángulo de desprendimiento muy positivo y una faceta T positiva y moderada. También es condicionalmente adecuado para aleaciones no férricas.

DNMG 110408E-NM:T8415	●	0.8	215	0.25	0.8	110	0.23	0.8	–	–	–	540	0.30	0.8	45	0.20	0.6	–	–	–
-----------------------	---	-----	-----	------	-----	-----	------	-----	---	---	---	-----	------	-----	----	------	-----	---	---	---

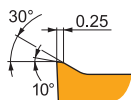
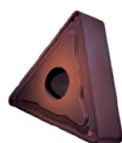

NM es un rompevirutas afilado y está diseñado para el mecanizado medio de aceros, aceros inoxidable y superaleaciones. Se caracteriza por un ángulo de desprendimiento muy positivo y una faceta T positiva y moderada. También es condicionalmente adecuado para aleaciones no férricas.

TNMG 160408E-NM:T8415	●	0.8	215	0.25	1.9	110	0.23	1.9	–	–	–	540	0.30	1.9	45	0.20	1.5	–	–	–
-----------------------	---	-----	-----	------	-----	-----	------	-----	---	---	---	-----	------	-----	----	------	-----	---	---	---

TNMG 220408E-NM:T8415	●	0.8	215	0.25	1.7	110	0.23	1.7	–	–	–	540	0.30	1.7	45	0.20	1.4	–	–	–
-----------------------	---	-----	-----	------	-----	-----	------	-----	---	---	---	-----	------	-----	----	------	-----	---	---	---

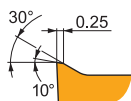

NM es un rompevirutas afilado y está diseñado para el mecanizado medio de aceros, aceros inoxidable y superaleaciones. Se caracteriza por un ángulo de desprendimiento muy positivo y una faceta T positiva y moderada. También es condicionalmente adecuado para aleaciones no férricas.

VNMG 160404E-NM:T8415	●	0.4	160	0.20	1.2	85	0.18	1.2	–	–	–	405	0.24	1.2	35	0.20	1.0	–	–	–
-----------------------	---	-----	-----	------	-----	----	------	-----	---	---	---	-----	------	-----	----	------	-----	---	---	---

VNMG 160408E-NM:T8415	●	0.8	180	0.25	1.4	90	0.23	1.4	–	–	–	450	0.30	1.4	40	0.20	1.1	–	–	–
-----------------------	---	-----	-----	------	-----	----	------	-----	---	---	---	-----	------	-----	----	------	-----	---	---	---

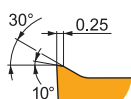
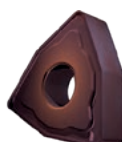

NM es un rompevirutas afilado y está diseñado para el mecanizado medio de aceros, aceros inoxidable y superaleaciones. Se caracteriza por un ángulo de desprendimiento muy positivo y una faceta T positiva y moderada. También es condicionalmente adecuado para aleaciones no férricas.

WNMG 080412E-NM:T8415	⚙️	1.2	245	0.30	2.1	125	0.27	2.1	–	–	–	615	0.36	2.1	55	0.24	1.7	–	–	–
-----------------------	----	-----	-----	------	-----	-----	------	-----	---	---	---	-----	------	-----	----	------	-----	---	---	---



.NMA

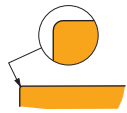

...A es una plaquita plana diseñada para el mecanizado medio de fundición. Presenta un ángulo de desprendimiento neutro sin faceta T. También es condicionalmente adecuada para materiales duros.



CNMA

	IC (mm)	D1 (mm)	L (mm)	S (mm)
1204	12.700	5.16	12.90	4.76

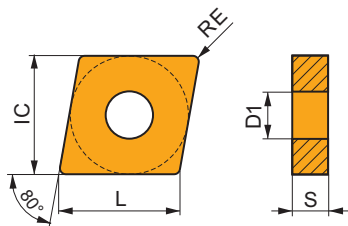

DNMA

	IC (mm)	D1 (mm)	L (mm)	S (mm)
1506	12.700	5.16	15.50	6.35

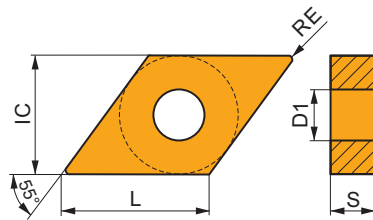

SNMA

	IC (mm)	D1 (mm)	L (mm)	S (mm)
1204	12.700	5.16	12.70	4.76

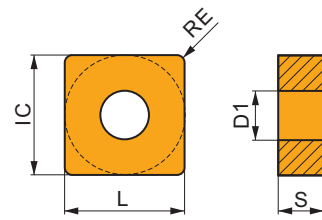

TNMA

	IC (mm)	D1 (mm)	L (mm)	S (mm)
1604	9.525	3.81	16.50	4.76
2204	12.700	5.16	22.00	4.76

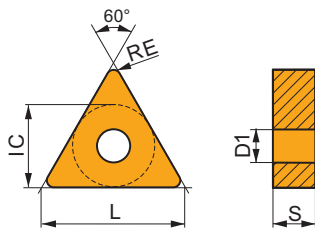

WNMA

	IC (mm)	D1 (mm)	L (mm)	S (mm)
0804	12.700	5.16	8.70	4.76

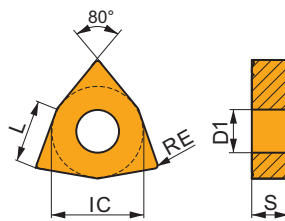



Valores de inicio adecuados para la velocidad de corte (vc), avance (f) y profundidad de corte (ap). Consulte nuestra APP Calculadora de mecanizado para obtener más cálculos.

Producto	Interrupted/ Continuous cut	RE (mm)	P			M			K			N			S			H		
			vc (m/min)	f (mm/rev)	ap (mm)	vc (m/min)	f (mm/rev)	ap (mm)	vc (m/min)	f (mm/rev)	ap (mm)	vc (m/min)	f (mm/rev)	ap (mm)	vc (m/min)	f (mm/rev)	ap (mm)	vc (m/min)	f (mm/rev)	ap (mm)

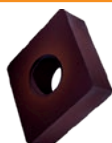

...A es una plaquita plana diseñada para el mecanizado medio de fundición. Presenta un ángulo de desprendimiento neutro sin faceta T. También es condicionalmente adecuada para materiales duros.

CNMA 120408:T8415	●	0.8	-	-	-	-	-	-	■	145	0.20	4.0	-	-	-	-	-	-	■	25	0.14	0.5
CNMA 120412:T8415	●	1.2	-	-	-	-	-	-	■	135	0.30	4.0	-	-	-	-	-	-	■	25	0.21	0.5

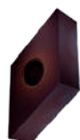

...A es una plaquita plana diseñada para el mecanizado medio de fundición. Presenta un ángulo de desprendimiento neutro sin faceta T. También es condicionalmente adecuada para materiales duros.

DNMA 150604:T8415	●	0.4	-	-	-	-	-	-	■	130	0.10	1.7	-	-	-	-	-	-	■	25	0.07	0.5
DNMA 150608:T8415	●	0.8	-	-	-	-	-	-	■	125	0.20	1.7	-	-	-	-	-	-	■	20	0.14	0.5

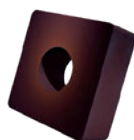

...A es una plaquita plana diseñada para el mecanizado medio de fundición. Presenta un ángulo de desprendimiento neutro sin faceta T. También es condicionalmente adecuada para materiales duros.

SNMA 120408:T8415	●	0.8	-	-	-	-	-	-	■	150	0.20	4.0	-	-	-	-	-	-	■	25	0.14	0.5
-------------------	---	-----	---	---	---	---	---	---	---	-----	------	-----	---	---	---	---	---	---	---	----	------	-----

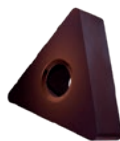

...A es una plaquita plana diseñada para el mecanizado medio de fundición. Presenta un ángulo de desprendimiento neutro sin faceta T. También es condicionalmente adecuada para materiales duros.

TNMA 160408:T8415	●	0.8	-	-	-	-	-	-	■	135	0.20	1.5	-	-	-	-	-	-	■	25	0.14	0.5
TNMA 220408:T8415	●	0.8	-	-	-	-	-	-	■	130	0.20	2.0	-	-	-	-	-	-	■	25	0.14	0.5

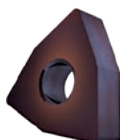

...A es una plaquita plana diseñada para el mecanizado medio de fundición. Presenta un ángulo de desprendimiento neutro sin faceta T. También es condicionalmente adecuada para materiales duros.

WNMA 080408:T8415	●	0.8	-	-	-	-	-	-	■	145	0.20	4.0	-	-	-	-	-	-	■	25	0.14	0.5
WNMA 080412:T8415	●	1.2	-	-	-	-	-	-	■	135	0.30	4.0	-	-	-	-	-	-	■	25	0.21	0.5



RM

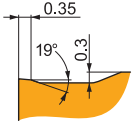

RM es un rompevirutas robusto y la primera elección para el desbaste de aceros. Se caracteriza por un ángulo de desprendimiento positivo y una faceta T estable y ancha. También es adecuado para aceros inoxidables, fundiciones, y condicionalmente, para superaleaciones.



CNMG

	IC (mm)	D1 (mm)	L (mm)	S (mm)
1204	12.700	5.16	12.90	4.76
1606	15.875	6.35	16.10	6.35
1906	19.050	7.94	19.30	6.35

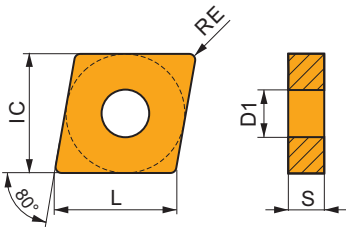

DNMG

	IC (mm)	D1 (mm)	L (mm)	S (mm)
1506	12.700	5.16	15.50	6.35

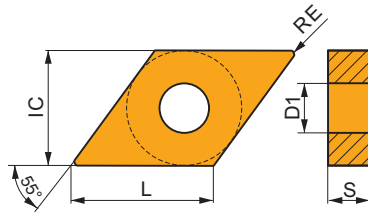

SNMG

	IC (mm)	D1 (mm)	L (mm)	S (mm)
1204	12.700	5.16	12.70	4.76
1506	15.875	6.35	15.88	6.35
1906	19.050	7.94	19.05	6.35

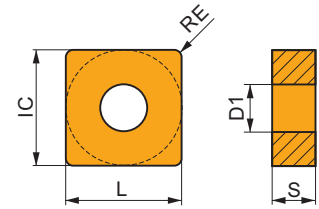

WNMG

	IC (mm)	D1 (mm)	L (mm)	S (mm)
0804	12.700	5.16	8.70	4.76

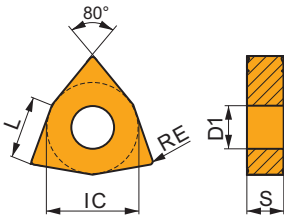



Valores de inicio adecuados para la velocidad de corte (vc), avance (f) y profundidad de corte (ap). Consulte nuestra APP Calculadora de mecanizado para obtener más cálculos.

Producto	Interrupted/ Continuous cut	RE (mm)	P			M			K			N			S			H		
			vc (m/min)	f (mm/rev)	ap (mm)	vc (m/min)	f (mm/rev)	ap (mm)	vc (m/min)	f (mm/rev)	ap (mm)	vc (m/min)	f (mm/rev)	ap (mm)	vc (m/min)	f (mm/rev)	ap (mm)	vc (m/min)	f (mm/rev)	ap (mm)

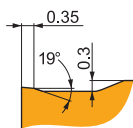
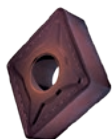

RM es un rompevirutas robusto y la primera elección para el desbaste de aceros. Se caracteriza por un ángulo de desprendimiento positivo y una faceta T estable y ancha. También es adecuado para aceros inoxidables, fundiciones y, condicionalmente, para superaleaciones.

CNMG 120408E-RM:T8415	●	0.8	195	0.40	4.0	100	0.36	4.0	180	0.40	4.0	-	-	-	45	0.28	3.2	-	-	-
CNMG 120412E-RM:T8415	●	1.2	200	0.45	4.0	105	0.41	4.0	185	0.45	4.0	-	-	-	45	0.32	3.2	-	-	-
CNMG 160612E-RM:T8415	●	1.2	195	0.45	6.0	100	0.41	6.0	180	0.45	6.0	-	-	-	45	0.32	4.8	-	-	-
CNMG 190612E-RM:T8415	●	1.2	195	0.45	7.5	100	0.41	7.5	180	0.45	7.5	-	-	-	45	0.32	6.0	-	-	-
CNMG 190616E-RM:T8415	●	1.6	195	0.50	7.5	100	0.45	7.5	180	0.50	7.5	-	-	-	45	0.35	6.0	-	-	-

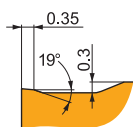

RM es un rompevirutas robusto y la primera elección para el desbaste de aceros. Se caracteriza por un ángulo de desprendimiento positivo y una faceta T estable y ancha. También es adecuado para aceros inoxidables, fundiciones y, condicionalmente, para superaleaciones.

DNMG 150608E-RM:T8415	●	0.8	160	0.40	3.0	85	0.36	3.0	145	0.40	3.0	-	-	-	35	0.28	2.4	-	-	-
-----------------------	---	-----	-----	------	-----	----	------	-----	-----	------	-----	---	---	---	----	------	-----	---	---	---

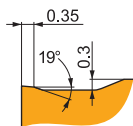
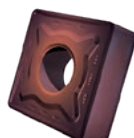

RM es un rompevirutas robusto y la primera elección para el desbaste de aceros. Se caracteriza por un ángulo de desprendimiento positivo y una faceta T estable y ancha. También es adecuado para aceros inoxidables, fundiciones y, condicionalmente, para superaleaciones.

SNMG 120408E-RM:T8415	●	0.8	210	0.40	4.0	110	0.36	4.0	190	0.40	4.0	-	-	-	45	0.28	3.2	-	-	-
SNMG 120412E-RM:T8415	●	1.2	215	0.45	4.0	110	0.41	4.0	195	0.45	4.0	-	-	-	45	0.32	3.2	-	-	-
SNMG 150612E-RM:T8415	●	1.2	215	0.45	5.0	110	0.41	5.0	195	0.45	5.0	-	-	-	45	0.32	4.0	-	-	-
SNMG 190616E-RM:T8415	●	1.6	210	0.50	7.0	110	0.45	7.0	190	0.50	7.0	-	-	-	45	0.35	5.6	-	-	-

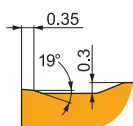
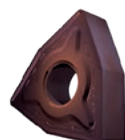

RM es un rompevirutas robusto y la primera elección para el desbaste de aceros. Se caracteriza por un ángulo de desprendimiento positivo y una faceta T estable y ancha. También es adecuado para aceros inoxidables, fundiciones y, condicionalmente, para superaleaciones.

WNMG 080408E-RM:T8415	●	0.8	195	0.40	4.0	100	0.36	4.0	180	0.40	4.0	-	-	-	45	0.28	3.2	-	-	-
-----------------------	---	-----	-----	------	-----	-----	------	-----	-----	------	-----	---	---	---	----	------	-----	---	---	---



SSO12

FRESADO VERSÁTIL DE ALTO AVANCE

INTRODUCCIÓN



Presentamos la familia de fresas Pramet SSO12. Unas nuevas y versátiles fresas de alto avance diseñadas para el mecanizado de piezas difíciles en la industria de los moldes y matrices. Herramientas fiables con bajas vibraciones, ruido reducido y una excepcional eficiencia energética. Con una acción de corte suave, una mayor vida útil de la herramienta y un importante ahorro de energía: una inversión inteligente en versatilidad y rendimiento.



PRAMET

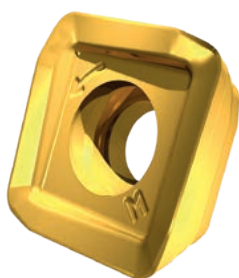

SOHT-M

- Plaquita HFC versátil de 4 filos
- Aceros, fundiciones, aceros duros
- Cortes medios hasta desbastados

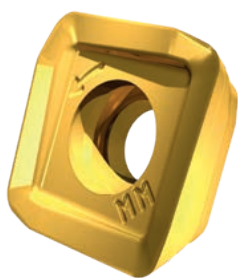

SOHT-MM

- Plaquita afilada HFC de 4 cortes
- Aceros blandos, aceros inoxidable, HRSA
- Cortes de ligeros a medios



PLAQUITAS – CARACTERÍSTICAS Y VENTAJAS

Dos geometrías fiables: M con faceta T neutra y MM con faceta T positiva.



FÁCIL DE ELEGIR, SENCILLO DE USAR

M para materiales resistentes, MM para materiales blandos.

Los flancos positivos y las caras de asiento rectificadas con precisión mejoran la estabilidad de la fijación.



VIDA ÚTIL LARGA Y CONSISTENTE

en cualquier operación de fresado de alto avance.

Ángulo de ajuste axial positivo y ángulo de desprendimiento positivo y faceta T.



PERFECTA EVACUACIÓN DE VIRUTAS HACIA ARRIBA

lo que la hace ideal para el cajeado profundo y el fresado de agujeros transversales.

Las fresas de precisión con baja desviación radial evitan el recorte de virutas contra la pared.



ACABADO LISO DE LA SUPERFICIE DE LA PARED

no más virutas pegadas en la pared.

Filo rascador largo y muy positivo paralelo a la cara y a la pared.



ACABADO LISO DE LA CARA

después de las operaciones de fresado frontal.





SSO12

FRESADO VERSÁTIL DE ALTO AVANCE

FRESAS SSO12 – CARACTERÍSTICAS Y VENTAJAS

Forma optimizada del asiento de la plaquita



MONTAJE SENCILLO

y fácil manejo de plaquitas.

Forma optimizada de los asientos de plaquitas en equilibrio con el reducido paso entre dientes.



EVACUACIÓN SEGURA DE LA VIRUTA

en cualquier aplicación de fresado HFC.

Diámetro de montaje de las fresas en función de la conexión estándar del usillo.



TRANSMISIÓN FIABLE DEL PAR

desde el husillo hasta el filo de corte.

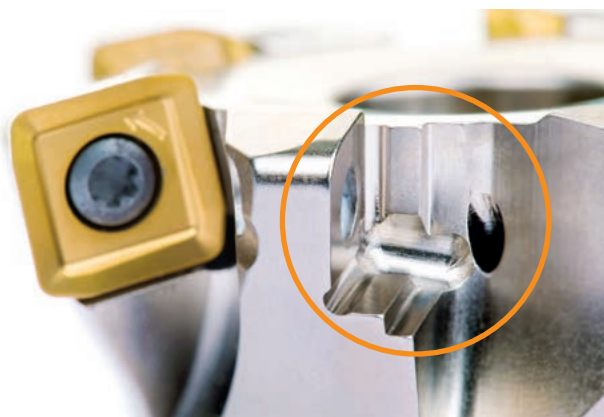

Tornillos de sujeción grandes de fácil acceso



SSO12

- Mango modular
- Rango métrico: 35 – 40 mm
- Rango imperial: 1.50"



SSO12

- Mango cilíndrico
- Rango métrico: 35 – 40 mm
- Rango imperial: 1.50"



SSO12

- Portafresas
- Alcance DC: 42 – 125 mm
- Alcance en pulgadas: 2.0 – 5.0"

**SSO12****FRESADO VERSÁTIL DE ALTO AVANCE****EJEMPLOS DE FRESADO DE ALTO AVANCE****Pieza de trabajo:** Fresado frontal de chapa de acero**Material:** S355NL / 1.0546 (160 HB)**Fresa:** 63A06R-SMOSO12-C**Refrigerante:** No (sólo aire comprimido)**Condiciones de corte:**

v_c	f_z	a_p	a_e	TOH
250	0.96	0.6	44	160

Prueba de la geometría de la plaquita

Vida útil de la herramienta

SOHT 120514SR-MM:M8330**175 min (+133%)****WMG P2.1**

La fresa Pramet SSO12 funciona significativamente más suave que la del competidor, y según el pequeño desgaste duraría muchos más minutos. Incluso se ha probado un avance más rápido $F = 10800\text{mm/min}$ (+50%), ¡y el corte sigue siendo completamente estable y fluido!

Pieza de trabajo: Aspa de turbina de acero inoxidable**Material:** 1.4301 / X5CrNi18 – 10 / SUS304 (170 HB)**Fresa:** 50A05R-SMOSO12-C**Refrigerante:** Sí (externa, emulsión de aceite soluble)**Condiciones de corte:**

v_c	f_z	a_p	a_e	TOH
125	0.31	1	17.5	140

Prueba de la geometría de la plaquita

Vida útil de la herramienta

SOHT 120514SR-MM:M6330**35 min (+133%)****WMG M3.1**

Todas las fresas de la competencia estaban todo el tiempo enterradas en virutas, se producían roturas repentinas de plaquitas y fresas. La fresa Pramet SSO12 terminó el trabajo gracias a una mejor evacuación de la viruta.

Pieza de trabajo: Fresado frontal y copiado en acero fundido**Material:** G20Mn6N / 1.6220 (180 HB)**Fresa:** 63A06R-SMOSO12-C**Refrigerante:** No (sólo aire comprimido)**Condiciones de corte:**

v_c	f_z	a_p	a_e	TOH
257	0.64	1.4	60	60

Prueba de la geometría de la plaquita

Vida útil de la herramienta

SOHT 120514SR-M:8215**56 min (+35%)****WMG P3.1**

Las fresas Pramet SSO12 consiguieron una mayor vida útil de la herramienta, superando a la competencia al fabricar cuatro piezas en lugar de sólo tres

Pieza de trabajo: Placa base para aerogenerador**Material:** 26NiCrMoV11-5 / 1.6948 (360 HB)**Fresa:** 63A06R-SMOSO12-C**Refrigerante:** No (sólo aire comprimido)**Condiciones de corte:**

v_c	f_z	a_p	a_e	TOH
162	1.55	0.65	38	140

Prueba de la geometría de la plaquita

Vida útil de la herramienta

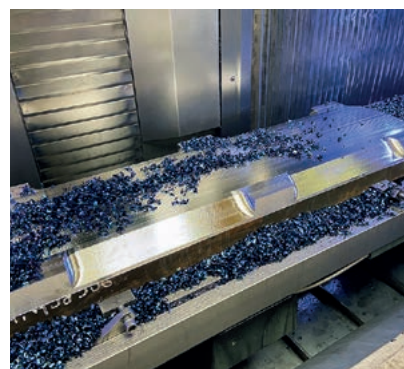
SOHT 120514SR-M:M8330**150 min (+42%)****WMG P3.3**

La solución Pramet SSO12 aumentó la vida útil de la herramienta hasta un 142% y consiguió una mejor calidad superficial ($Ra\ 1.0$) que la competencia.



SSO12



PRAMET

S



VER S012 12° Fresado de alto avance con refrigeración interna

Fresa de alto avance de 12° "SO.. 12" muy versátil que utiliza plaquitas de una sola cara, con APMX de 1,9 mm. Adecuada para una amplia gama de aplicaciones en la mayoría de materiales. Disponibles con mango cilíndrico, modular y para porta fresas, con paso diferencial. Refrigerante a través de canales y cuerpo tratado para una mayor duración de la herramienta.

KAPR	12°
APMX	1.9 mm

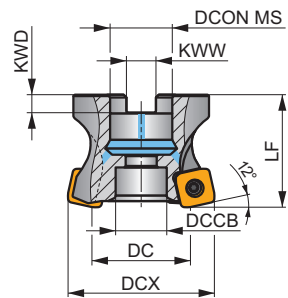
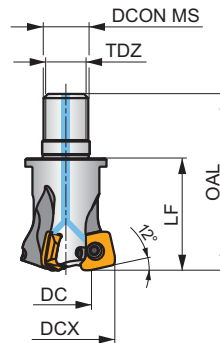
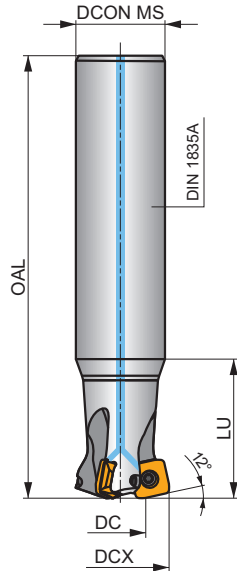
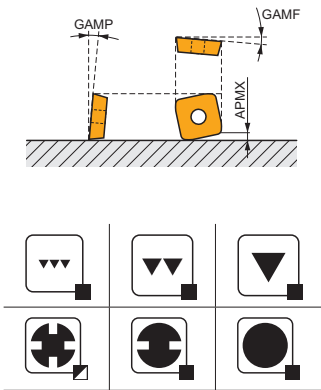

	0.09-0.93
	0.09-0.93



Producto	DCX	DC	OAL	DCON MS	DCCB	LU	LF	TDZ	KWW	KWD	GAMF	GAMP				kg			
	(mm)	(mm)	(mm)	(mm)	(mm)	(mm)	(mm)	(mm)	(mm)	(mm)	(°)	(°)							
35E3R050A32-SSO12-C	35	17.3	200	32	-	50	-	-	-	-	-5	5	3	-	15700	✓	1.07	GI350 SQ501	-
35E3R120A32-SSO12-C	35	17.3	200	32	-	120	-	-	-	-	-5	5	3	-	15700	✓	0.95	GI350 SQ501	-
40E4R120A32-SSO12-C	40	22.3	200	32	-	120	-	-	-	-	-5	5	4	-	14700	✓	1.00	GI350 SQ501	-
35E3R040M16-SSO12-C	35	17.3	63	17	-	40	M16	-	-	-	-5	5	3	-	15700	✓	0.15	GI350 SQ501	-
40E4R043M16-SSO12-C	40	22.3	66	17	-	43	M16	-	-	-	-5	5	4	-	14700	✓	0.18	GI350 SQ501	-
42A04R-SMOS012-C	42	24.3	-	16	12.4	-	40	-	8.4	5.6	-5	5	4	-	14300	✓	0.16	GI350 SQ502	-
50A05R-SMOS012-C	50	32.3	-	22	18.1	-	40	-	10.4	6.3	-5	5	5	✓	13100	✓	0.23	GI350 SQ503	-
52A05R-SMOS012-C	52	34.3	-	22	18.1	-	40	-	10.4	6.3	-5	5	5	✓	12800	✓	0.35	GI350 SQ503	-
63A06R-SMOS012-C	63	45.3	-	27	22.1	-	50	-	12.4	7	-5	5	6	✓	11700	✓	0.48	GI350 SQ504	-
66A06R-SMOS012-C	66	48.3	-	27	22.1	-	50	-	12.4	7	-5	5	6	✓	11400	✓	0.51	GI350 SQ504	-
80A07R-SMOS012-C	80	62.3	-	27	22.1	-	50	-	12.4	7	-5	5	7	✓	10400	✓	0.76	GI350 SQ504	-
100A08R-SMOS012-C	100	82.3	-	32	45.1	-	50	-	14.4	8	-5	5	8	✓	9300	✓	1.32	GI350 SQ505 AC002	-
125A10R-SMOS012-C	125	107.3	-	40	56.1	-	63	-	16.4	9	-5	5	10	✓	8300	✓	2.46	GI350 SQ505 AC003	-

	GI350		SOHT 1205..
--	-------	--	-------------

SQ501	US 4011-T15P	3.5	M 4	10.6	FLAG T15P	-	-
SQ502	US 4011-T15P	3.5	M 4	10.6	-	SDRT15P-T	HCS 0840C
SQ503	US 4011-T15P	3.5	M 4	10.6	-	SDRT15P-T	HS 1030C
SQ504	US 4011-T15P	3.5	M 4	10.6	-	SDRT15P-T	HS 1230C
SQ505	US 4011-T15P	3.5	M 4	10.6	-	SDRT15P-T	-



AC002	KS 1635	K.FMH32
AC003	KS 2040	K.FMH40

SOHT 12



	IC	D1	S
	(mm)	(mm)	(mm)
1205	12.700	4.50	5.15

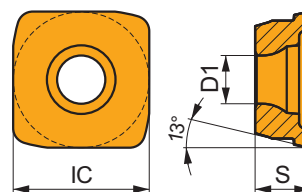

Valores de inicio adecuados para la velocidad de corte (vc), avance (f) y profundidad de corte (ap). Consulte nuestra APP Calculadora de mecanizado para obtener más cálculos.

Producto	Interrupted/ Continuous cut	RE (mm)	P			M			K			N			S			H		
			vc (m/min)	f (mm/tooth)	ap (mm)	vc (m/min)	f (mm/tooth)	ap (mm)	vc (m/min)	f (mm/tooth)	ap (mm)	vc (m/min)	f (mm/tooth)	ap (mm)	vc (m/min)	f (mm/tooth)	ap (mm)	vc (m/min)	f (mm/tooth)	ap (mm)

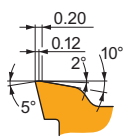

La geometría M es adecuada para una amplia gama de condiciones de trabajo. Diseñada con desprendimiento positivo, faceta T media y redondeo del filo de corte para un fresado HFC suave. Primera elección para aceros, fundiciones y aceros endurecidos.

SOHT 120514SR-M:8215	✳	1.4	■	215	1.00	1.0	■	125	0.90	1.0	■	200	1.00	1.0	■	50	0.70	0.8	■	40	0.68	0.8
SOHT 120514SR-M:M8310	✳	1.4	■	225	1.00	1.0	■	110	0.90	1.0	■	210	1.00	1.0	■	-	-	-	■	45	0.68	0.8
SOHT 120514SR-M:M8330	✳	1.4	■	220	1.00	1.0	■	130	0.90	1.0	■	205	1.00	1.0	■	55	0.70	0.8	■	40	0.68	0.8
SOHT 120514SR-M:M8340	✳	1.4	■	205	1.00	1.0	■	120	0.90	1.0	■	190	1.00	1.0	■	50	0.70	0.8	■	-	-	-
SOHT 120514SR-M:M9325	✳	1.4	■	245	1.00	1.0	■	-	-	-	■	230	1.00	1.0	■	-	-	-	■	45	0.68	0.8
SOHT 120514SR-M:M9340	✳	1.4	■	215	1.00	1.0	■	125	0.90	1.0	■	-	-	-	■	50	0.70	0.8	■	-	-	-

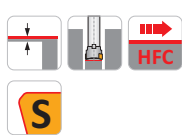
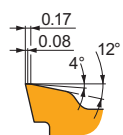

Geometría MM afilada, adecuada para aplicaciones con grandes voladizos o piezas de paredes finas y delgadas. Diseñada con desprendimiento positivo, faceta T estrecha y un redondeo del filo de corte para un fresado HFC suave. Primera elección para aceros inoxidables y superaleaciones.

SOHT 120514SR-MM:M6330	✳	1.4	■	190	1.00	1.0	■	135	0.90	1.0	■	-	-	-	■	55	0.70	0.8	■	-	-	-
SOHT 120514SR-MM:M8340	✳	1.4	■	205	1.00	1.0	■	120	0.90	1.0	■	-	-	-	■	50	0.70	0.8	■	-	-	-
SOHT 120514SR-MM:M8345	✳	1.4	■	165	1.00	1.0	■	95	0.90	1.0	■	-	-	-	■	40	0.70	0.8	■	-	-	-
SOHT 120514SR-MM:M9325	✳	1.4	■	245	1.00	1.0	■	-	-	-	■	-	-	-	■	-	-	-	■	-	-	-
SOHT 120514SR-MM:M9340	✳	1.4	■	215	1.00	1.0	■	125	0.90	1.0	■	-	-	-	■	50	0.70	0.8	■	-	-	-



a_e DCX	5%	10%	15%	20%	25%	30%	40%	50%	60%	70%	75%	80%	90%	100%
	1.48	1.35	1.27	1.22	1.19	1.16	1.11	1.08	1.05	1.03	1.00	1.00	1.00	1.00
	2.20	1.60	1.35	1.20	1.10	0.95	0.85	0.75	0.85	0.95	1.00	1.00	1.00	1.00
	0.64	0.64	0.64	0.64	0.64	0.65	0.65	0.67	0.68	0.71	0.72	0.74	0.79	1.00

	SOHT 12-M	SOHT 12-MM
	1.4	1.4
	2.00	2.00

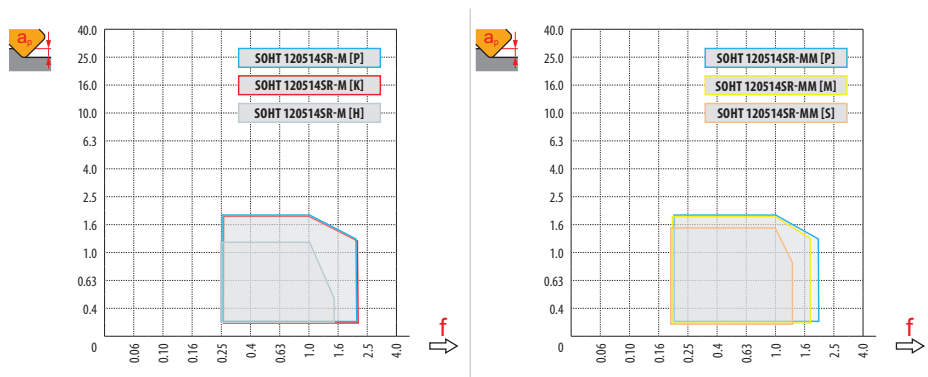

HFC														
		0.00	0.20	0.40	0.60	0.80	1.00	1.20	1.40	1.50	1.60	1.70	1.80	1.90
35		17.3	19.2	21.1	22.9	24.8	26.7	28.6	30.5	31.4	32.4	33.1	33.5	33.9
40		22.3	24.2	26.1	27.9	29.8	31.7	33.6	35.5	36.4	37.4	38.1	38.5	38.9
42		24.3	26.2	28.1	29.9	31.8	33.7	35.6	37.5	38.4	39.4	40.1	40.5	40.9
50		32.3	34.2	36.1	37.9	39.8	41.7	43.6	45.5	46.4	47.4	48.1	48.5	48.9
52		34.3	36.2	38.1	39.9	41.8	43.7	45.6	47.5	48.4	49.4	50.1	50.5	50.9
63		45.3	47.2	49.1	50.9	52.8	54.7	56.6	58.5	59.4	60.4	61.1	61.5	61.9
66		48.3	50.2	52.1	53.9	55.8	57.7	59.6	61.5	62.4	63.4	64.1	64.5	64.9
80		62.3	64.2	66.1	67.9	69.8	71.7	73.6	75.5	76.4	77.4	78.1	78.5	78.9
100		82.3	84.2	86.1	87.9	89.8	91.7	93.6	95.5	96.4	97.4	98.1	98.5	98.9
125		107.3	109.2	111.1	112.9	114.8	116.7	118.6	120.5	121.4	122.4	123.1	123.5	123.9
		0.00	0.20	0.40	0.60	0.80	1.00	1.20	1.40	1.50	1.60	1.70	1.80	1.90
		-	2.20	2.00	1.80	1.60	1.40	1.20	1.10	1.00	0.90	0.80	0.70	0.60

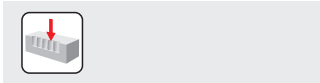

DCX	a_{emax}	f_{max}
35	10.0	0.10
40	10.0	0.10
42	10.0	0.12
50	10.0	0.12
52	10.0	0.12
63	10.0	0.15
66	10.0	0.15
80	10.0	0.20
100	10.0	0.20
125	10.0	0.20

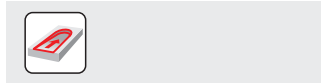

DCX	RPMX	APMX/II
35	9.6	1.9/11
40	6.9	1.9/16
42	6.1	1.9/18
50	4.3	1.9/25
52	4.0	1.9/27
63	2.6	1.9/41
66	2.5	1.9/44
80	1.9	1.9/59
100	1.4	1.9/79
125	1.0	1.9/105

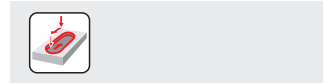

DCX	a_p	f_{max}
35	1.6	0.17
40	1.6	0.17
42	1.6	0.15
50	1.6	0.10
52	1.6	0.10
63	1.6	0.05
66	1.6	0.05
80	1.6	0.05
100	1.6	0.05
125	1.6	0.05



DCX	μm	3	5	10	15	20	30	40	50	60	80	100
35		0.648	0.837	1.183	1.449	1.673	2.049	2.366	2.646	2.898	3.347	3.742
40		0.693	0.894	1.265	1.549	1.789	2.191	2.530	2.828	3.098	3.578	4.000
42		0.710	0.917	1.296	1.587	1.833	2.245	2.592	2.898	3.175	3.666	4.099
50		0.775	1.000	1.414	1.732	2.000	2.449	2.828	3.162	3.464	4.000	4.472
52		0.790	1.020	1.442	1.766	2.040	2.498	2.884	3.225	3.533	4.079	4.561
63		0.869	1.122	1.587	1.944	2.245	2.750	3.175	3.550	3.888	4.490	5.020
66		0.890	1.149	1.625	1.990	2.298	2.814	3.250	3.633	3.980	4.596	5.138
80		0.980	1.265	1.789	2.191	2.530	3.098	3.578	4.000	4.382	5.060	5.657
100		1.095	1.414	2.000	2.449	2.828	3.464	4.000	4.472	4.899	5.657	6.325
125		1.225	1.581	2.236	2.739	3.162	3.873	4.472	5.000	5.477	6.325	7.071



a_p	0.2	0.6	1.0	1.5	1.9
f	2.0	1.6	1.2	0.8	0.5



DCX	D _{MIN}	D _{MAX}	D _{MIN}	D _{MAX}
35	46.0	69.8	1.9	1.9
40	56.0	79.8	1.9	1.9
42	60.0	83.8	1.9	1.9
50	76.0	99.8	1.9	1.9
52	80.0	103.8	1.9	1.9
63	102.0	125.8	1.9	1.9
66	108.0	131.8	1.9	1.9
80	136.0	159.8	1.9	1.9
100	176.0	199.8	1.9	1.9
125	226.0	249.8	1.9	1.9



SOHT	R	T
SOHT 120514	3.37	1.21



E559

MACHOS DE MANO ECONÓMICOS

INTRODUCCIÓN



Presentamos la gama E559 de Dormer, una nueva línea de machos de mano. El fiable diseño de la rosca garantiza un corte suave y una evacuación eficaz de la viruta. Nuestra extensa gama incluye las roscas M, MF, UNC y UNF más utilizadas, disponibles en una amplia gama de tamaños. El macho Dormer E559 es la elección económica adecuada para mecánicos de mantenimiento, ingenieros de servicio de campo, artesanos, ingenieros contratados e instituciones educativas.

 **DORMER**



EXPLICACIÓN MACHOS DE MANO

- + Los machos de mano cortan siempre un perfil de rosca completo
- + Se puede utilizar cualquier macho para roscar agujeros pasantes
- Limitaciones de las longitudes de rosca que se pueden utilizar en agujeros ciegos



E559N01

- Entrada cónica



E599N02

- Semi acabado de rosca



E559N03

- Acabado de rosca



HERRAMIENTAS DE ROSCADO

MACHOS DE MANO – VISIÓN GENERAL

Macho de roscar manual entrada cónica de canal recto, norma ISO

Macho versátil para uso manual o en máquina en aceros de resistencia media, de contenido medio en carbono y aceros aleados. Con una entrada cónica que produce virutas más finas proporcionando una acción de corte muy gradual y suave. Considerado como la mejor opción para producir agujeros pasantes cortos de hasta 1.5xD.

E559NO1(M)

- Rosca métrica: M3 – M20

E559NO1(MF)

- Rosca métrica-fina: M8x1 – M16x1.5

E559NO1(UNC)

- Rosca UNC: No. 10-24 – 1/2"

E559NO1(UNF)

- Rosca UNF: No. 10-32 – 1/2"-20

Macho de mano de canal recto para semi acabado, norma ISO

Macho versátil para uso manual o en máquina en aceros de resistencia media, de contenido medio en carbono y aceros aleados. Con un chaflán que proporciona al macho una acción de corte gradual. Ideales para producir agujeros pasantes, ya que son casi tan fáciles de iniciar como los machos de roscar cónicos, pero también ofrecen un juego de rosca más completo.

E559NO2(M)

- Rosca métrica: M3 – M20

E559NO2(MF)

- Rosca métrica-fina: M8x1 – M16x1.5

E559NO2(UNC)

- Rosca UNC: No. 10-24 – 1/2"

E559NO2(UNF)

- Rosca UNF: No. 10-32 – 1/2"-20

Macho manual de paso recto para acabado de roscas, norma ISO

Macho versátil para aceros al carbono y aleados de resistencia media. Con paso de rosca hasta el fondo, que aunque es difícil empezar a roscar con él, es capaz de cortar la rosca casi hasta el fondo de un agujero ciego. Se utiliza mejor como macho de máquina o, si se utiliza a mano, en secuencia después del macho cónico y el macho semi acabado.

E559NO3(M)

- Rosca métrica: M3 – M20

E559-NO3(MF)

- Rosca métrica-fina: M8x1 – M16x1.5

E559-NO3(UNC)

- Rosca UNC: No. 10-24 – 1/2"

E559-NO3(UNF)

- Rosca UNF: No. 10-32 – 1/2"-20

Juego de 3 machos de roscar manuales de canal recto, norma ISO

Los machos más versátiles para uso manual o en máquina en aceros de resistencia media, de contenido medio en carbono y aceros aleados. El juego incluye machos con 3 longitudes de chaflán diferentes: entrada cónica, ideal para agujeros pasantes cortos; semi acabado, perfecto para agujeros pasantes más profundos y de acabado, más adecuado para agujeros ciegos.

E559NO6(M)

- Rosca métrica: M3 – M20

E559NO6(MF)

- Rosca métrica-fina: M8x1 – M16x1.5

E559NO6(UNC)

- Rosca UNC: No. 10-24 – 1/2"

E559NO6(UNF)

- Rosca UNF: No. 10-32 – 1/2"-20



E559

MACHOS DE MANO ECONÓMICOS

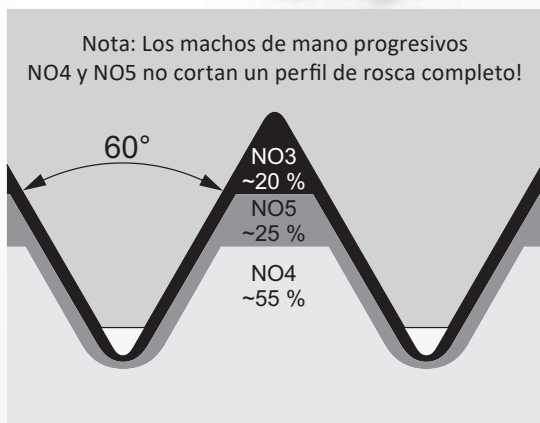

EXPLICACIÓN JUEGO DE MACHOS DE MANO PROGRESIVOS

- + Este juego de machos progresivos requiere menor fuerza de corte, ideal para usar con porta machos
- + Este juego de machos progresivos puede ser una solución a problemas en el roscado de materiales más duros.
- Los machos progresivos deben utilizarse siempre en secuencia de NO4 a NO3.

E559NO4

- Macho inicial

E559NO5

- Macho intermedio

E559NO3

- Macho de acabado
(corte hasta el fondo de la rosca)



HERRAMIENTAS DE ROSCADO

MACHOS PROGRESIVOS – VISIÓN GENERAL

Juego de 3 machos de mano progresivos canal rectos, norma ISO

Ideal para el roscado manual de materiales duros. Los canales rectos lo hacen adecuado tanto para agujeros pasantes como ciegos. Juego de 3 machos para usar en secuencia, primero el macho inicial para hacer un corte de desbaste, segundo el intermedio para continuar la rosca y el tercero, de acabado, para terminar la rosca.



Juego de 2 machos progresivos de canal recto, norma ISO

Ideal para el roscado manual de materiales duros. Los canales rectos lo hacen adecuado tanto para agujeros pasantes como ciegos. Juego de 2 machos para usar en secuencia, primero el macho inicial, para hacer un corte de desbaste y un macho de acabado para terminar la rosca.





A113

BROCA HSS ACABADO BRILLANTE

INTRODUCCIÓN



Presentamos la broca rentable Dormer A113 en HSS para uso general con acabado brillante. La punta convencional de 118° proporciona resistencia, mientras que el acabado brillante mejora el flujo de la viruta y su evacuación, especialmente en aleaciones férreas y no férreas, blandas y de viruta larga. El fácil reafilado múltiple aporta un valor añadido para mecánicos de mantenimiento, ingenieros de servicio de campo, artesanos, ingenieros contratados e instituciones educativas.



 **DORMER**



A113



- Broca HSS serie corta
- Acabado brillante
- Gama métrica: 0.8 – 14 mm
- Gama imperial: 3/64 – 35/64"



A113

DORMER



Broca HSS serie corta, acabado brillante

Una broca versátil y multifuncional con una punta convencional de 118°, que proporciona resistencia y es fácil de reafilar, lo que la hace muy rentable en aplicaciones de uso general. Utilizable para taladrar a mano y a máquina. El acabado brillante mejora el flujo de viruta en materiales blandos féreos o no féreos.

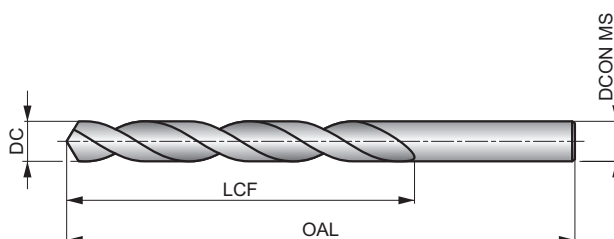

HSS	DIN 338	4xD
118°	Bright	
λ 20-35°	R	DC h8

Grupo de Material de la pieza adecuado y condiciones de velocidad de corte iniciales (m/min) y código de avance alfabético. Tablas con avance por revolución a partir de la pag.XY.

P1.1 ■ 29 H	P1.2 ■ 33 H	P1.3 ■ 33 H	P2.1 ■ 25 H	P2.2 ■ 22 F	P2.3 ■ 19 E	K1.1 ■ 26 H	K1.2 ■ 19 F	K1.3 ■ 15 F	K2.1 ■ 22 E	K2.2 ■ 18 E	K2.3 ■ 14 E	N1.1 ■ 29 J	N1.2 ■ 22 J
N1.3 ■ 15 I	N2.1 ■ 37 H	N2.2 ■ 33 H	N2.3 ■ 24 H	N3.1 ■ 52 H	N3.2 ■ 31 I	N3.3 ■ 16 G							

Producto	DC (inch)	DC (mm)	DC (inch)	LCF (mm)	OAL (mm)	DCON MS (mm)
A113.8	-	0.80	0.0315	10.0	30.0	0.80
A113.9	-	0.90	0.0354	11.0	32.0	0.90
A1131.0	-	1.00	0.0394	12.0	34.0	1.00
A113N60	N60	1.02	0.0402	12.0	34.0	1.02
A1131.05	-	1.05	0.0413	12.0	34.0	1.05
A113N57	N57	1.09	0.0429	14.0	36.0	1.09
A1131.1	-	1.10	0.0433	14.0	36.0	1.10
A113N56	N56	1.18	0.0465	14.0	36.0	1.18
A1133/64	3/64	1.19	0.0469	16.0	38.0	1.19
A1131.2	-	1.20	0.0472	16.0	38.0	1.20
A1131.3	-	1.30	0.0512	16.0	38.0	1.30
A113N55	N55	1.32	0.0520	16.0	38.0	1.32
A1131.35	-	1.35	0.0531	18.0	40.0	1.35
A1131.4	-	1.40	0.0551	18.0	40.0	1.40
A1131.5	-	1.50	0.0591	18.0	40.0	1.50
A113N53	N53	1.51	0.0594	20.0	43.0	1.51
A1131.55	-	1.55	0.0610	20.0	43.0	1.55
A1131/16	1/16	1.59	0.0625	20.0	43.0	1.59
A1131.6	-	1.60	0.0630	20.0	43.0	1.60
A113N52	N52	1.61	0.0634	20.0	43.0	1.61
A1131.65	-	1.65	0.0650	20.0	43.0	1.65
A1131.7	-	1.70	0.0669	20.0	43.0	1.70
A113N50	N50	1.78	0.0701	22.0	46.0	1.78
A1131.8	-	1.80	0.0709	22.0	46.0	1.80
A113N49	N49	1.85	0.0728	22.0	46.0	1.85
A1131.9	-	1.90	0.0748	22.0	46.0	1.90
A113N48	N48	1.93	0.0760	24.0	49.0	1.93
A1131.95	-	1.95	0.0768	24.0	49.0	1.95
A1135/64	5/64	1.98	0.0781	24.0	49.0	1.98
A1132.0	-	2.00	0.0787	24.0	49.0	2.00

Producto	DC (inch)	DC (mm)	DC (inch)	LCF (mm)	OAL (mm)	DCON MS (mm)
A113N46	N46	2.06	0.0811	24.0	49.0	2.06
A1132.1	-	2.10	0.0827	24.0	49.0	2.10
A113N44	N44	2.18	0.0858	27.0	53.0	2.18
A1132.2	-	2.20	0.0866	27.0	53.0	2.20
A113N43	N43	2.26	0.0890	27.0	53.0	2.26
A1132.3	-	2.30	0.0906	27.0	53.0	2.30
A113N42	N42	2.37	0.0933	30.0	57.0	2.37
A1133/32	3/32	2.38	0.0938	30.0	57.0	2.38
A1132.4	-	2.40	0.0945	30.0	57.0	2.40
A113N41	N41	2.44	0.0961	30.0	57.0	2.44
A1132.5	-	2.50	0.0984	30.0	57.0	2.50
A113N39	N39	2.53	0.0996	30.0	57.0	2.53
A1132.55	-	2.55	0.1004	30.0	57.0	2.55
A1132.6	-	2.60	0.1024	30.0	57.0	2.60
A113N37	N37	2.64	0.1039	30.0	57.0	2.64
A1132.7	-	2.70	0.1063	33.0	61.0	2.70
A113N36	N36	2.71	0.1067	33.0	61.0	2.71
A1132.75	-	2.75	0.1083	33.0	61.0	2.75
A1137/64	7/64	2.78	0.1094	33.0	61.0	2.78
A1132.8	-	2.80	0.1102	33.0	61.0	2.80
A113N34	N34	2.82	0.1110	33.0	61.0	2.82
A113N33	N33	2.87	0.1130	33.0	61.0	2.87
A1132.9	-	2.90	0.1142	33.0	61.0	2.90
A113N32	N32	2.95	0.1161	33.0	61.0	2.95
A1133.0	-	3.00	0.1181	33.0	61.0	3.00
A113N31	N31	3.05	0.1201	36.0	65.0	3.05
A1133.1	-	3.10	0.1220	36.0	65.0	3.10
A1131/8	1/8	3.17	0.1250	36.0	65.0	3.17
A1133.2	-	3.20	0.1260	36.0	65.0	3.20
A1133.25	-	3.25	0.1280	36.0	65.0	3.25



Producto	DC	DC	DC	LCF	OAL	DCON MS
	(inch)	(mm)	(inch)	(mm)	(mm)	(mm)
A113N30	N30	3.26	0.1283	36.0	65.0	3.26
A1133.3	–	3.30	0.1299	36.0	65.0	3.30
A1133.4	–	3.40	0.1339	39.0	70.0	3.40
A113N29	N29	3.45	0.1358	39.0	70.0	3.45
A1133.5	–	3.50	0.1378	39.0	70.0	3.50
A1139/64	9/64	3.57	0.1406	39.0	70.0	3.57
A1133.6	–	3.60	0.1417	39.0	70.0	3.60
A1133.7	–	3.70	0.1457	39.0	70.0	3.70
A113N26	N26	3.73	0.1469	39.0	70.0	3.73
A113N25	N25	3.80	0.1496	43.0	75.0	3.80
A1133.8	–	3.80	0.1496	43.0	75.0	3.80
A113N24	N24	3.86	0.1520	43.0	75.0	3.86
A1133.9	–	3.90	0.1535	43.0	75.0	3.90
A113N23	N23	3.91	0.1539	43.0	75.0	3.91
A1133.95	–	3.95	0.1555	43.0	75.0	3.95
A1135/32	5/32	3.97	0.1563	43.0	75.0	3.97
A113N22	N22	3.99	0.1571	43.0	75.0	3.99
A1134.0	–	4.00	0.1575	43.0	75.0	4.00
A113N21	N21	4.04	0.1591	43.0	75.0	4.04
A1134.05	–	4.05	0.1594	43.0	75.0	4.05
A113N20	N20	4.09	0.1610	43.0	75.0	4.09
A1134.1	–	4.10	0.1614	43.0	75.0	4.10
A1134.15	–	4.15	0.1634	43.0	75.0	4.15
A1134.2	–	4.20	0.1654	43.0	75.0	4.20
A1134.25	–	4.25	0.1673	43.0	75.0	4.25
A1134.3	–	4.30	0.1693	47.0	80.0	4.30
A11311/64	11/64	4.37	0.1719	47.0	80.0	4.37
A1134.4	–	4.40	0.1732	47.0	80.0	4.40
A1134.5	–	4.50	0.1772	47.0	80.0	4.50
A1134.6	–	4.60	0.1811	47.0	80.0	4.60
A1134.7	–	4.70	0.1850	47.0	80.0	4.70
A1133/16	3/16	4.76	0.1875	52.0	86.0	4.76
A1134.8	–	4.80	0.1890	52.0	86.0	4.80
A113N11	N11	4.85	0.1909	52.0	86.0	4.85
A1134.9	–	4.90	0.1929	52.0	86.0	4.90
A113N10	N10	4.92	0.1937	52.0	86.0	4.92
A1134.95	–	4.95	0.1949	52.0	86.0	4.95
A1135.0	–	5.00	0.1969	52.0	86.0	5.00
A113N8	N8	5.06	0.1992	52.0	86.0	5.06
A1135.1	–	5.10	0.2008	52.0	86.0	5.10
A11313/64	13/64	5.16	0.2031	52.0	86.0	5.16
A1135.2	–	5.20	0.2047	52.0	86.0	5.20
A1135.3	–	5.30	0.2087	52.0	86.0	5.30
A1135.4	–	5.40	0.2126	57.0	93.0	5.40
A1135.5	–	5.50	0.2165	57.0	93.0	5.50
A1137/32	7/32	5.56	0.2188	57.0	93.0	5.56
A1135.6	–	5.60	0.2205	57.0	93.0	5.60
A1135.7	–	5.70	0.2244	57.0	93.0	5.70
A1135.8	–	5.80	0.2283	57.0	93.0	5.80
A1135.9	–	5.90	0.2323	57.0	93.0	5.90
A11315/64	15/64	5.95	0.2344	57.0	93.0	5.95
A1136.0	–	6.00	0.2362	57.0	93.0	6.00
A113B	B	6.04	0.2378	63.0	101.0	6.04
A1136.1	–	6.10	0.2402	63.0	101.0	6.10
A1136.2	–	6.20	0.2441	63.0	101.0	6.20
A1136.3	–	6.30	0.2480	63.0	101.0	6.30
A1131/4	1/4	6.35	0.2500	63.0	101.0	6.35
A1136.4	–	6.40	0.2520	63.0	101.0	6.40
A1136.5	–	6.50	0.2559	63.0	101.0	6.50
A1136.6	–	6.60	0.2598	63.0	101.0	6.60
A113G	G	6.63	0.2610	63.0	101.0	6.63
A1136.7	–	6.70	0.2638	63.0	101.0	6.70

Producto	DC	DC	DC	LCF	OAL	DCON MS
	(inch)	(mm)	(inch)	(mm)	(mm)	(mm)
A11317/64	17/64	6.75	0.2656	69.0	109.0	6.75
A1136.8	–	6.80	0.2677	69.0	109.0	6.80
A1136.9	–	6.90	0.2717	69.0	109.0	6.90
A1137.0	–	7.00	0.2756	69.0	109.0	7.00
A1137.1	–	7.10	0.2795	69.0	109.0	7.10
A1139/32	9/32	7.14	0.2813	69.0	109.0	7.14
A1137.2	–	7.20	0.2835	69.0	109.0	7.20
A1137.3	–	7.30	0.2874	69.0	109.0	7.30
A1137.4	–	7.40	0.2913	69.0	109.0	7.40
A1137.5	–	7.50	0.2953	69.0	109.0	7.50
A11319/64	19/64	7.54	0.2969	75.0	117.0	7.54
A1137.6	–	7.60	0.2992	75.0	117.0	7.60
A1137.7	–	7.70	0.3031	75.0	117.0	7.70
A1137.8	–	7.80	0.3071	75.0	117.0	7.80
A1137.9	–	7.90	0.3110	75.0	117.0	7.90
A1135/16	5/16	7.94	0.3125	75.0	117.0	7.94
A1138.0	–	8.00	0.3150	75.0	117.0	8.00
A1138.1	–	8.10	0.3189	75.0	117.0	8.10
A1138.2	–	8.20	0.3228	75.0	117.0	8.20
A1138.3	–	8.30	0.3268	75.0	117.0	8.30
A11321/64	21/64	8.33	0.3281	75.0	117.0	8.33
A1138.4	–	8.40	0.3307	75.0	117.0	8.40
A1138.5	–	8.50	0.3346	75.0	117.0	8.50
A1138.6	–	8.60	0.3386	81.0	125.0	8.60
A1138.7	–	8.70	0.3425	81.0	125.0	8.70
A11311/32	11/32	8.73	0.3438	81.0	125.0	8.73
A1138.8	–	8.80	0.3465	81.0	125.0	8.80
A1135	S	8.84	0.3480	81.0	125.0	8.84
A1138.9	–	8.90	0.3504	81.0	125.0	8.90
A1139.0	–	9.00	0.3543	81.0	125.0	9.00
A1139.1	–	9.10	0.3583	81.0	125.0	9.10
A11323/64	23/64	9.13	0.3594	81.0	125.0	9.13
A1139.2	–	9.20	0.3622	81.0	125.0	9.20
A1139.3	–	9.30	0.3661	81.0	125.0	9.30
A113U	U	9.34	0.3677	81.0	125.0	9.34
A1139.4	–	9.40	0.3701	81.0	125.0	9.40
A1139.5	–	9.50	0.3740	81.0	125.0	9.50
A1133/8	3/8	9.53	0.3750	87.0	133.0	9.53
A1139.6	–	9.60	0.3780	87.0	133.0	9.60
A1139.7	–	9.70	0.3819	87.0	133.0	9.70
A1139.8	–	9.80	0.3858	87.0	133.0	9.80
A1139.9	–	9.90	0.3898	87.0	133.0	9.90
A11325/64	25/64	9.92	0.3906	87.0	133.0	9.92
A11310.0	–	10.00	0.3937	87.0	133.0	10.00
A11310.1	–	10.10	0.3976	87.0	133.0	10.10
A11310.2	–	10.20	0.4016	87.0	133.0	10.20
A11310.3	–	10.30	0.4055	87.0	133.0	10.30
A11313/32	13/32	10.32	0.4063	87.0	133.0	10.32
A11310.4	–	10.40	0.4094	87.0	133.0	10.40
A11310.5	–	10.50	0.4134	87.0	133.0	10.50
A11310.6	–	10.60	0.4173	87.0	133.0	10.60
A11310.7	–	10.70	0.4213	94.0	142.0	10.70
A11327/64	27/64	10.72	0.4219	94.0	142.0	10.72
A11310.8	–	10.80	0.4252	94.0	142.0	10.80
A11310.9	–	10.90	0.4291	94.0	142.0	10.90
A11311.0	–	11.00	0.4331	94.0	142.0	11.00
A11311.1	–	11.10	0.4370	94.0	142.0	11.10
A1137/16	7/16	11.11	0.4375	94.0	142.0	11.11
A11311.2	–	11.20	0.4409	94.0	142.0	11.20
A11311.3	–	11.30	0.4449	94.0	142.0	11.30
A11311.4	–	11.40	0.4488	94.0	142.0	11.40
A11311.5	–	11.50	0.4528	94.0	142.0	11.50



Producto	DC	DC	DC	LCF	OAL	DCON MS
	(inch)	(mm)	(inch)	(mm)	(mm)	(mm)
A11329/64	29/64	11.51	0.4531	94.0	142.0	11.51
A11311.6	–	11.60	0.4567	94.0	142.0	11.60
A11311.7	–	11.70	0.4606	94.0	142.0	11.70
A11311.8	–	11.80	0.4646	94.0	142.0	11.80
A11311.9	–	11.90	0.4685	101.0	151.0	11.90
A11315/32	15/32	11.91	0.4688	101.0	151.0	11.91
A11312.0	–	12.00	0.4724	101.0	151.0	12.00
A11312.1	–	12.10	0.4764	101.0	151.0	12.10
A11312.2	–	12.20	0.4803	101.0	151.0	12.20
A11312.3	–	12.30	0.4843	101.0	151.0	12.30
A11331/64	31/64	12.30	0.4844	101.0	151.0	12.30
A11312.4	–	12.40	0.4882	101.0	151.0	12.40
A11312.5	–	12.50	0.4921	101.0	151.0	12.50
A11312.6	–	12.60	0.4961	101.0	151.0	12.60
A1131/2	1/2	12.70	0.5000	101.0	151.0	12.70
A11312.7	–	12.70	0.5000	101.0	151.0	12.70

Producto	DC	DC	DC	LCF	OAL	DCON MS
	(inch)	(mm)	(inch)	(mm)	(mm)	(mm)
A11312.8	–	12.80	0.5039	101.0	151.0	12.80
A11312.9	–	12.90	0.5079	101.0	151.0	12.90
A11313.0	–	13.00	0.5118	101.0	151.0	13.00
A11333/64	33/64	13.10	0.5156	101.0	151.0	13.10
A11313.1	–	13.10	0.5157	101.0	151.0	13.10
A11313.2	–	13.20	0.5197	101.0	151.0	13.20
A11313.3	–	13.30	0.5236	108.0	160.0	13.30
A11313.4	–	13.40	0.5276	108.0	160.0	13.40
A11317/32	17/32	13.49	0.5313	108.0	160.0	13.49
A11313.5	–	13.50	0.5315	108.0	160.0	13.50
A11313.6	–	13.60	0.5354	108.0	160.0	13.60
A11313.7	–	13.70	0.5394	108.0	160.0	13.70
A11313.8	–	13.80	0.5433	108.0	160.0	13.80
A11335/64	35/64	13.89	0.5469	108.0	160.0	13.89
A11313.9	–	13.90	0.5472	108.0	160.0	13.90
A11314.0	–	14.00	0.5512	108.0	160.0	14.00



BARRAS PARA HERRAMIENTAS

BARRAS HSS-E

INTRODUCCIÓN



Presentamos una amplia gama de barras Dormer para herramientas de torneado. Fabricadas en acero brillante T2000S HSS-E con un contenido de cobalto del 10%, rectificadas según las normas DIN 4964. Estas herramientas alcanzan un robusto nivel de dureza de 65 – 67 HRC, garantizando un rendimiento de torneado preciso y fiable.



F

- Barra rectangular HSS-E
- Gama métrica:
8 × 6 – 30 × 20 mm



R

- Barra redonda HSS-E
- Gama métrica:
D3 – D20 mm



S

- Barra cuadrada HSS-E
- Gama métrica:
4 × 4 – 25 × 25 mm



SA

- Barra cuadrada HSS-E con bisel
- Gama métrica:
4 × 4 – 25 × 25 mm
- Gama imperial:
3/16 × 3/16 – 5/8 × 5/8



TOOL BITS F

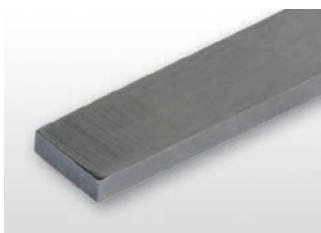

Barra rectangular HSS-E

Barra rectangular rectificada según norma DIN 4964 D. Acero brillante T2000S HSS-E con 10% de contenido de cobalto en dureza 65 – 67 HRC.



HSS-E	DIN 4964D	Bright
h13		

Producto	H (mm)	B (mm)	OAL (mm)
8X6X200:T2000S	8	6	200.0
10X2X200:T2000S	10	2	200.0
10X3X200:T2000S	10	3	200.0
10X4X200:T2000S	10	4	200.0
10X5X200:T2000S	10	5	200.0
10X6X200:T2000S	10	6	200.0
10X8X200:T2000S	10	8	200.0
12X3X200:T2000S	12	3	200.0
12X4X200:T2000S	12	4	200.0
12X6X200:T2000S	12	6	200.0
12X8X200:T2000S	12	8	200.0
15X3X200:T2000S	15	3	200.0
15X4X200:T2000S	15	4	200.0
15X5X200:T2000S	15	5	200.0
15X6X200:T2000S	15	6	200.0
15X8X200:T2000S	15	8	200.0
15X10X200:T2000S	15	10	200.0
16X8X200:T2000S	16	8	200.0
16X10X200:T2000S	16	10	200.0

Producto	H (mm)	B (mm)	OAL (mm)
16X12X200:T2000S	16	12	200.0
20X3X200:T2000S	20	3	200.0
20X4X200:T2000S	20	4	200.0
20X5X200:T2000S	20	5	200.0
20X6X200:T2000S	20	6	200.0
20X8X200:T2000S	20	8	200.0
20X10X200:T2000S	20	10	200.0
20X12X200:T2000S	20	12	200.0
20X15X200:T2000S	20	15	200.0
25X5X200:T2000S	25	5	200.0
25X6X200:T2000S	25	6	200.0
25X10X200:T2000S	25	10	200.0
25X12X200:T2000S	25	12	200.0
30X4X200:T2000S	30	4	200.0
30X5X200:T2000S	30	5	200.0
30X10X200:T2000S	30	10	200.0
30X15X200:T2000S	30	15	200.0
30X20X200:T2000S	30	20	200.0



TOOL BITS R

DORMER



Barra redonda HSS-E

Barra redonda rectificada según norma DIN 4964 A. Acero brillante T2000S HSS-E con 10% de contenido de cobalto en dureza 65 – 67 HRC.

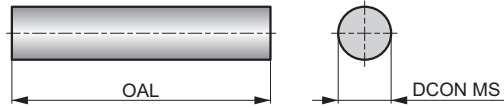

HSS-E	DIN 4964A	Bright
h9		

Producto	DCON MS	OAL
	(mm)	(mm)
3X200 T:T2000S	3.00	200.0
4X200 T:T2000S	4.00	200.0
5X200 T:T2000S	5.00	200.0
6X200 T:T2000S	6.00	200.0
7X200 T:T2000S	7.00	200.0
8X200 T:T2000S	8.00	200.0
10X200 T:T2000S	10.00	200.0
12X200 T:T2000S	12.00	200.0
14X200 T:T2000S	14.00	200.0
16X200 T:T2000S	16.00	200.0
20X200 T:T2000S	20.00	200.0



TOOL BITS S



Barra cuadrada HSS-E

Barra cuadrada rectificada según norma DIN 4964 B. Acero brillante T2000S HSS-E con 10% de contenido de cobalto en dureza 65 – 67 HRC.

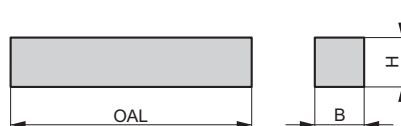

HSS-E	DIN 4964B	Bright
+0 -0.1		

Producto	H (mm)	B (mm)	OAL (mm)
4X4X200:T2000S	4	4	200.0
6X6X200:T2000S	6	6	200.0
8X8X200:T2000S	8	8	200.0
10X10X200:T2000S	10	10	200.0
12X12X200:T2000S	12	12	200.0
14X14X200:T2000S	14	14	200.0
15X15X200:T2000S	15	15	200.0
16X16X200:T2000S	16	16	200.0
20X20X200:T2000S	20	20	200.0
25X25X200:T2000S	25	25	200.0



TOOL BITS SA

DORMER

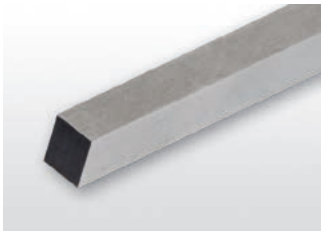

Barra cuadrada HSS-E con bisel

Barra cuadrada rectificada con extremos biselados según norma DIN 4964 B. Acero brillante T2000S HSS-E con 10% de contenido de cobalto en dureza 65 – 67 HRC.

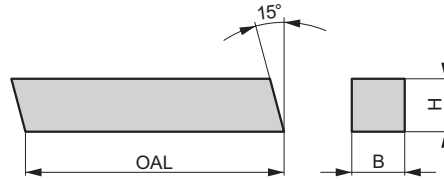

HSS-E	DIN 4964B	Bright
h13		

Producto	H	B	OAL	H	B	OAL
	(mm)	(mm)	(mm)	(inch)	(inch)	(inch)
4X4X200A:T2000S	4	4	200.0	—	—	—
6X6X100A:T2000S	6	6	100.0	—	—	—
6X6X200A:T2000S	6	6	200.0	—	—	—
8X8X100A:T2000S	8	8	100.0	—	—	—
8X8X160A:T2000S	8	8	160.0	—	—	—
8X8X200A:T2000S	8	8	200.0	—	—	—
10X10X100A:T2000S	10	10	100.0	—	—	—
10X10X160A:T2000S	10	10	160.0	—	—	—
10X10X200A:T2000S	10	10	200.0	—	—	—
12X12X100A:T2000S	12	12	100.0	—	—	—
12X12X200A:T2000S	12	12	200.0	—	—	—
14X14X200A:T2000S	14	14	200.0	—	—	—
15X15X200A:T2000S	15	15	200.0	—	—	—
16X16X200A:T2000S	16	16	200.0	—	—	—
20X20X200A:T2000S	20	20	200.0	—	—	—
25X25X200A:T2000S	25	25	200.0	—	—	—
3/16X3/16X2.1/2A:T2000S	—	—	—	3/16	3/16	2.500
1/4X1/4X2.1/2A:T2000S	—	—	—	1/4	1/4	2.500
1/4X1/4X4A:T2000S	—	—	—	1/4	1/4	4.000
5/16X5/16X2.1/2A:T2000S	—	—	—	5/16	5/16	2.500
5/16X5/16X4A:T2000S	—	—	—	5/16	5/16	4.000
3/8X3/8X3A:T2000S	—	—	—	3/8	3/8	3.000
3/8X3/8X4A:T2000S	—	—	—	3/8	3/8	4.000
3/8X3/8X6A:T2000S	—	—	—	3/8	3/8	6.000
1/2X1/2X4A:T2000S	—	—	—	1/2	1/2	4.000
1/2X1/2X6A:T2000S	—	—	—	1/2	1/2	6.000
5/8X5/8X6A:T2000S	—	—	—	5/8	5/8	6.000









INFORMACIÓN TÉCNICA



FACTORES DE CORRECCIÓN – TORNEADO

Factores de corrección para el tipo específico de operación C_{VCO}

  f															
	0.5			1.5			2.5			5.0			12.0		
	I	II	III	I	II	III	I	II	III	I	II	III	I	II	III
	0.05	0.08	0.10	0.10	0.15	0.20	0.20	0.30	0.40	0.40	0.60	0.80	0.80	1.00	1.30
Rompevirutas para acabado fino (FF, FF2...)	1.15	1.00	0.95	0.85	0.80	-	-	-	-	-	-	-	-	-	-
Rompevirutas para acabado (NF, SF...)	-	-	1.20	1.05	1.00	1.05	1.00	0.90	-	-	-	-	-	-	-
Rompevirutas para mecanizado medio (FM, M, NM, NMR, SM...)	-	-	-	-	-	1.15	1.10	1.00	0.95	0.85	-	-	-	-	-
Rompevirutas para desbaste (RM, NRM, NR, R...)	-	-	-	-	-	-	-	-	1.25	1.10	1.00	0.95	0.65	-	-
Rompevirutas para desbaste pesado (HR, HR2, NR2, OR...) para una duración de 45 min	-	-	-	-	-	-	-	-	-	1.25	1.20	1.15	1.05	1.00	0.95

Factores de corrección para durabilidad requerida C_{VCT}

	minutos	10	15	20	30	45	60
Operaciones de mecanizado general (desde acabado fino hasta desbaste)		1.13	1.00	0.93	0.84	0.76	0.71
Operaciones de mecanizado pesadas (desbaste pesado)		-	-	-	1.10	1.00	0.93

Factores de corrección adicionales C_{VCA}

Entorno de mecanizado	C_{VCA}
Condiciones del material de trabajo (capa dura debido a la forja o a la fundición)	0.70
Torneado interior	0.75
Tronzado y ranurado (radial)	0.88
Ranurado frontal	0.80
Corte interrumpido	0.80
Condiciones de mecanizado inestables	0.85
Condiciones de mecanizado estándar	1.00
Condiciones de mecanizado estables	1.20

Velocidad de corte corregida v_{CC} resultante

$$v_{CC} = v_c \times k_{VG} \times C_{VCO} \times C_{VCT} \times C_{VCA}$$





v_c – velocidad inicial de la página del catálogo

k_{VG} – coeficiente de material usado



FACTORES DE CORRECCIÓN – FRESAS INTERCAMBIABLES

Factores de corrección para un tipo específico de fresa y de operación C_{VCO}

			
Fresas de planear con $KAPR$ 45° – 60° y plaquitas negativas (SHN06C, SHN09C, CHN09, ...)	1.15	1.00	0.85
Fresas de planear con $KAPR$ 45° y plaquitas positivas (SOE06Z, SOE09Z, SOD05....)	1.15	1.00	0.85
Fresas de escuadrar con $KAPR$ 90° (SAD07D, SAD11E, SAD16E, SLN12, SLN16..)	1.10	1.00	0.90
Fresas de copiado (SRC10-SRC20, SRD05 – SRD16, ...)	1.10	1.00	0.90
Fresas de copiado con mango (K2-PPH, K2-SLC, K2-SRC, K3-CXP...)	1.10	1.00	0.90
Fresas de disco (S90CN(XN), S90SN...)	1.10	1.00	0.90
Fresas de escuadrar de filo largo J(T)-CSD12X, J(T)-SAD11E, J(T)-SAD16E...)	1.25	1.00	0.80
Fresas de planear para mecanizado pesado (FSB22X, SPN13..)	1.30	1.00	0.85
Fresas de escuadrar para mecanizado pesado (FTB27X..)	1.25	1.00	0.85

Factores de corrección para durabilidad requerida C_{VCT}

	minutos	15	20	30	45	60	90	120
Operaciones de mecanizado general (desde acabado fino hasta desbaste)	1.23	1.13	1.00	0.89	0.81	0.72	–	–
Operaciones de mecanizado pesadas (desbaste pesado)	–	–	1.23	1.13	1.00	0.89	0.81	–

Factores de corrección adicionales C_{VCA}

Entorno de mecanizado	C_{VCA}
Condiciones del material de trabajo (capa dura debido a la forja o a la fundición)	0.70
Condiciones de mecanizado inestables	0.85
Condiciones de mecanizado estándar	1.00
Condiciones de mecanizado estables	1.20

Factores de corrección de la velocidad de corte para refrentado y escuadrado con < 100 % de inmersión radial C_{VCRCT}

$\frac{a_p}{DC}$	5 %	10 %	15 %	20 %	25 %	30 %	40 %	50 %	60 %	70 %	75 %	80 %	90 %	100 %
	1.48	1.35	1.27	1.22	1.19	1.16	1.11	1.08	1.05	1.03	1.00	1.00	1.00	1.00

Velocidad de corte corregida v_{CC} resultante

$$v_{CC} = v_c \times k_{VG} \times C_{VCO} \times C_{VCT} \times C_{VCA} \times C_{fzRCT}$$

v_c – velocidad inicial de la página del catálogo

k_{VG} – coeficiente de material usado



WMG (GRUPO DE MATERIAL)

GRUPO ISO	WMG (GRUPO DE MATERIAL)		Dureza (HB o HRC)	Restistencia Traccion (MPa)	Factor de corrección kvG			
P	P1	P1.1	Sulfurizados	< 240 HB	≤ 830	1.33		
		P1.2	Acero facil mecanizado (aceros al carbono con mayor maquinabilidad)	Sulfurizados y fosforizados	< 180 HB	≤ 620	1.49	
		P1.3		Sulfurizados/fosforizados y al plomo	< 180 HB	≤ 620	1.53	
	P2	P2.1	ACEROS AL CARBONO (aceros compuestos principalmente de hierro y carbono)	Contiene < 0.25 % C	< 180 HB	≤ 620	1.14	
		P2.2		Contiene < 0.55 % C	< 240 HB	≤ 830	1.00	
		P2.3		Contiene > 0.55 % C	< 300 HB	≤ 1030	0.89	
	P3	P3.1	ACEROS ALEADOS (aceros al carbono con un contenido de aleación del 10 %)	Recocido	< 180 HB	≤ 620	0.92	
		P3.2		Templado y endurecido	180 – 260 HB	> 620 ≤ 900	0.74	
		P3.3			260 – 360 HB	> 900 ≤ 1240	0.63	
	P4	P4.1	ACERO DE HERRAMIENTAS (aleaciones especiales para herramientas, moldes y matrices)	Recocido	< 26 HRC	≤ 900	0.55	
P4.2		Templado y endurecido		26 – 39 HRC	> 900 ≤ 1240	0.47		
P4.3				39 – 45 HRC	> 1240 ≤ 1450	0.38		
M	M1	M1.1	ACERO INOXIDABLE FERRITICO (aleaciones al cromo no endurecidas)	< 160 HB	≤ 520	1.22		
				160 – 220 HB	> 520 ≤ 700	1.03		
	M2	M2.1	ACERO INOXIDABLE MARTENSITICO (aleaciones al cromo endurecidas)	Recocido	< 200 HB	≤ 670	1.08	
				M2.2	Enfriadas y templadas	200 – 280 HB	> 670 ≤ 950	0.89
				M2.3	Templado por precipitacion	280 – 380 HB	> 950 ≤ 1300	0.75
	M3	M3.1	ACERO INOXIDABLE AUSTENITICO (aleaciones cromo - niquel y cromo - niquel - manganeso)	< 200 HB	≤ 750	1.00		
				M3.2	200 – 260 HB	> 750 ≤ 870	0.86	
				M3.3	260 – 300 HB	> 870 ≤ 1040	0.77	
	M4	M4.1	AUTENITICO-FERRITICO (DUPLEX) O ACERO INOXIDABLE SUPER AUSTENITICO	< 300 HB	≤ 990	0.75		
		M4.2	ACEROS INOXIDABLE AUSTENITICOS ENDURECIDOS POR PRECIPITACION	300 – 380 HB	≤ 1320	0.64		
K	K1	K1.1	FUNDICION GRIS (ASTM A48) O FUNDICION GRIS AUTOMOCION (ASTM A159) (fundicion hierro - carbono con micro estructura de grafito laminar)	Ferritica o ferritica-perlitica	< 180 HB	≤ 190	1.35	
				Ferritica-perlitica o perlitica	180 – 240 HB	> 190 ≤ 310	1.00	
				Perlitica	240 – 280 HB	> 310 ≤ 390	0.75	
	K2	K2.1	FUNDICION MALEABLE (ASTM A602) (fundición de hierro-carbono con una microestructura libre de grafito)	Ferritica	< 160 HB	≤ 400	1.39	
				Ferritica o perlitica	160 – 200 HB	> 400 ≤ 550	1.13	
				Perlitica	200 – 240 HB	> 550 ≤ 660	0.90	
	K3	K3.1	FUNDICION DÚCTIL (ASTM A536) (fundición de hierro-carbono con microestructura de grafito nodular)	Ferritica	< 180 HB	≤ 560	1.23	
				Ferritica o perlitica	180 – 220 HB	> 560 ≤ 680	0.94	
				Perlitica	220 – 260 HB	> 680 ≤ 800	0.76	
	K4	K4.1	FUNDICION GRIS AUSTENITICO (ASTM A436) (fundiciones de aleación de hierro-carbono con microestructura de grafito laminar austenitico)	< 180 HB	≤ 190	1.14		
< 240 HB				≤ 740	0.86			
K4.2		FUNDICION DÚCTIL AUSTENITICA (ASTM A439 o ASTM A571) (fundiciones de hierro-carbono con microestructura de grafito nodular austenitico)	< 280 HB	> 840 ≤ 980	0.63			
			280 – 320 HB	> 980 ≤ 1130	0.54			
			320 – 360 HB	> 1130 ≤ 1280	0.45			
K5	K5.1	FUNDICION DE GRAFITO COMPACTADO CGI (ASTM A842) (fundición de hierro-carbono con estructura vermicular de grafito)	Ferritico	< 180 HB	≤ 400	1.29		
			Ferritico-perlitico	180 – 220 HB	> 400 ≤ 450	0.97		
			Perlitico	220 – 260 HB	> 450 ≤ 500	0.75		
N	N1	N1.1	Aluminio forjado comercialmente puro	< 60 HB	≤ 240	1.33		
				N1.2	Aleaciones de aluminio forjado	60 – 100 HB	> 240 ≤ 400	1.00
				N1.3		100 – 150 HB	> 400 ≤ 590	0.67
	N2	N2.1	Fundicion de aluminio	< 75 HB	≤ 240	0.67		
				N2.2	75 – 90 HB	> 240 ≤ 270	0.60	
				N2.3	90 – 140 HB	> 270 ≤ 440	0.43	
	N3	N3.1	Aleaciones de cobre de facil mecanizacion	-	-	0.70		
				N3.2	Aleaciones de cobre de viruta corta con maquinabilidad moderada	-	-	0.41
						N3.3	Cobre electrolitico y aleaciones de cobre de viruta larga con baja maquinabilidad	-
	N4	N4.1	Polimeros termoplasticos	-	-	0.70		
N4.2				Polimeros termoendurecibles	-	-	0.27	
N4.3				Composites o polimeros reforzados	-	-	0.29	
N5	N5.1	Grafito	-	-	1.00			
S	S1	S1.1	Titanio o aleaciones de titanio	< 200 HB	≤ 660	1.94		
				200 – 280 HB	> 660 ≤ 950	1.72		
				280 – 360 HB	> 950 ≤ 1200	1.44		
	S2	S2.1	Aleaciones termostresistentes con base hierro	< 200 HB	≤ 690	1.33		
				200 – 280 HB	> 690 ≤ 970	1.17		
	S3	S3.1	Aleaciones termostresistentes con base niquel	< 280 HB	≤ 940	1.00		
				280 – 360 HB	> 940 ≤ 1200	0.83		
	S4	S4.1	Aleaciones termostresistentes con base cobalto	< 240 HB	≤ 800	0.78		
240 – 320 HB				> 800 ≤ 1070	0.67			
H	H1	H1.1	Fundicion en frio	< 440 HB	-	1.52		
				< 55 HRC	-	0.90		
	H2	H2.1	Fundiciones templadas	> 55 HRC	-	0.77		
				< 51 HRC	-	1.00		
	H3	H3.1	Aceros templados < 55 HRC	51 – 55 HRC	-	0.82		
				55 – 59 HRC	-	0.64		
	H4	H4.1	Acero templados > 55 HRC	> 59 HRC	-	0.54		

SIMPLY RELIABLE

Como profesional se puede juzgar la calidad del trabajo sólo mirando la viruta. La viruta es una forma limpia y sin complicaciones, que en sí misma cuenta una historia. Es una señal clara y consistente y es por eso que la usamos como un símbolo por ser **simplemente fiables**.

DORMER PRAMET

www.dormerpramet.com



**CONTACTO DEL SOPORTE
DE VENTAS LOCAL
¡SIEMPRE ACTUALIZADO!**



DP-BRO-NEWS-2024-ES

FOLLOW US...



ONLINE



SEGMENTS



LIBRARY APP.



CALCULATOR APP.

