

DORMER PRAMET

NEW PRODUCTS

2024



 DORMER

 PRAMET

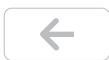

NEW PRODUCTS 2024 – CONTENT

2	R003 R023	VERSATILE SOLID CARBIDE DRILLS WITH TIN TIP
12	E697 E698	HIGHLY PRODUCTIVE MULTI APPLICATION TAPS (DIN/ANSI)
24	T8415	VERSATILE PVD TURNING GRADE
58	SSO12	VERSATILE HIGH FEED MILLING
66	E559	ECONOMICAL HAND AND SERIAL TAPS
70		HSS-E TOOL BITS
75		TECHNICAL INFORMATION



R003
R023

VERSATILE SOLID CARBIDE DRILLS WITH TIN TIP

INTRODUCTION



Introducing Dormer R003 and R023 – new general purpose, versatile solid carbide jobber and stub drills with a TiN tip coating. New design features result in excellent tool life, low cost per hole and high tool life consistency. The Dormer R003 and R023 also offer low thrust force making them versatile for both CNC and conventional machines operations.

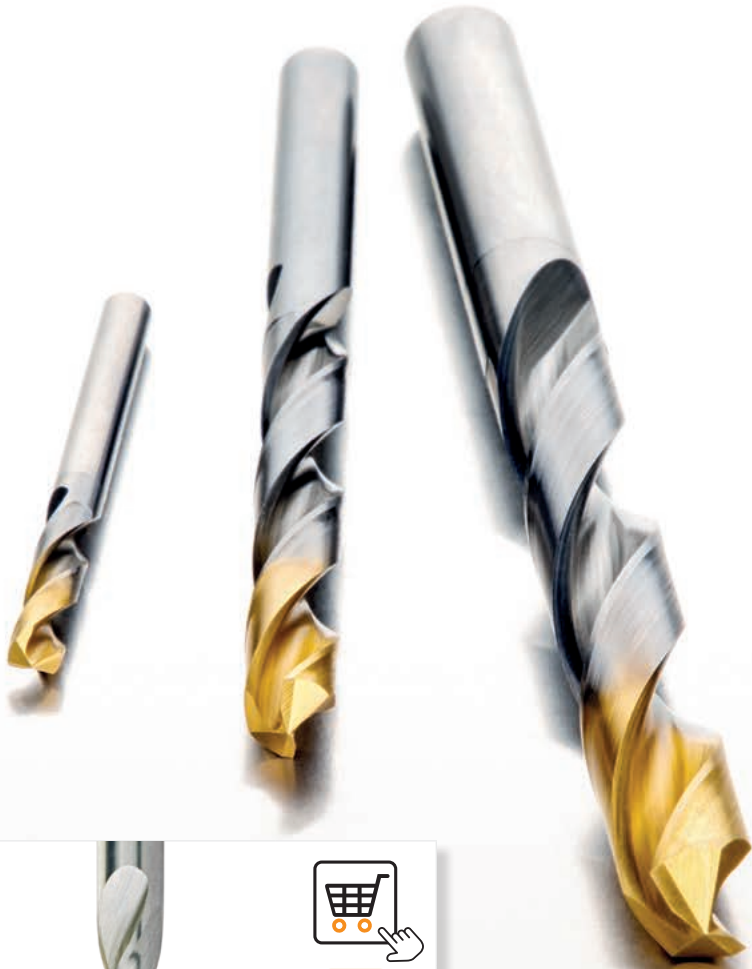



R003



- Solid carbide jobber drill
- Versatile, cost-effective
- Imperial range: N60 – 1/2"
- Metric range: 1 – 14 mm



R023



- Solid carbide stub drill
- Versatile, cost-effective
- Metric range: 1 – 12 mm



FEATURES AND BENEFITS

Specifically designed four facet split point provides excellent self-centering.

REDUCED THRUST FORCE
eases the operation whilst maintaining precision.

Titanium Nitride (TiN) tip coating on only the cutting action part of the drill.

EXTENDED AND CONSISTENT TOOL LIFE
provides cost-effective reliability.

CTW grinding technology provides Continuously Thinned Web along the entire flute length.

MULTIPLE REGRINDING POSSIBLE
without loss of chip evacuation performance.

Balanced combination of flute geometry and 120° point angle for broader application range.

VERSATILE USAGE
on both CNC and conventional machines.

Optimized point geometry with four facet split point

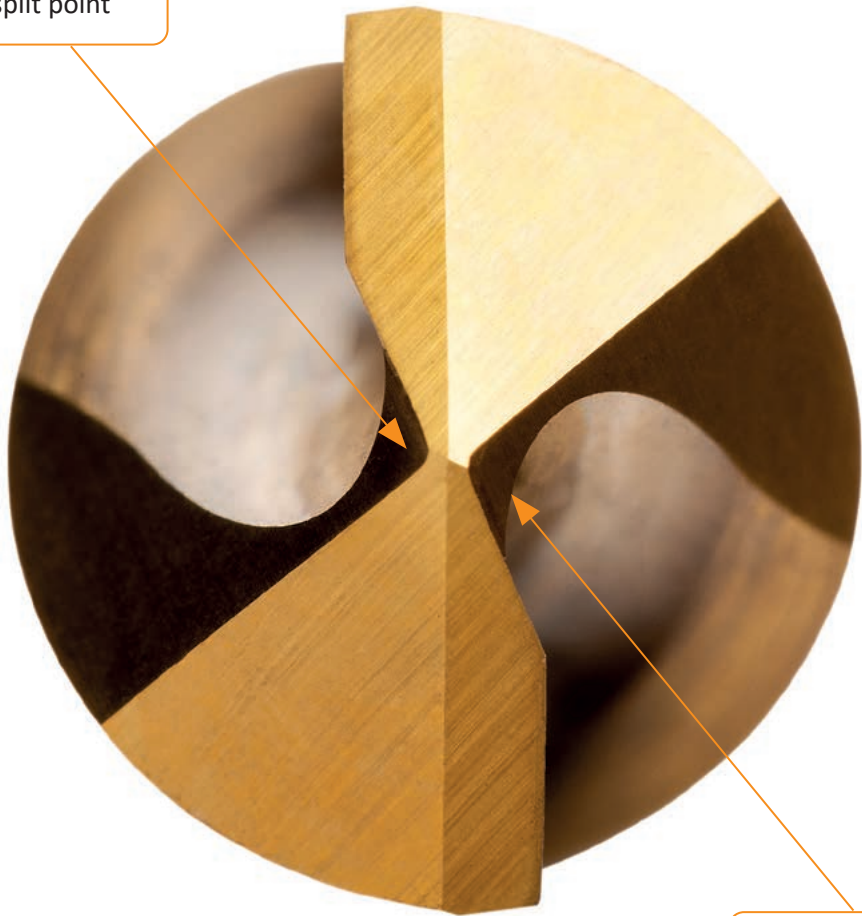

CTW
(Continuously thinned web)



**R003
R023**

VERSATILE SOLID CARBIDE DRILLS WITH TIN TIP

SUCCESS STORIES – R003 & R023

Segment: Power generation industry (Mexico)
Component: Assembly for electrical harnesses
Material: SAE 4140 / 1.7225 / 42CrMo4 (alloy steel, 190 HB)
Coolant: Yes, external, synthetic emulsion
Application: Haas CNC machine drilling with pecking, through holes
Previous results: Currently best competing drill has a high-end coating and a double margin, described to be a high performance drill.

Result with R003: Customer noticed lower thrust force when compared to other competing tools. R003 also provides comparable tool life and good hole finish, simply better cost effectiveness!

Dormer Pramet solution:

R0031/4

Machining data:

v_c	f_n	a_p
177 (54)	.008 (0.2)	.500 (12.7)

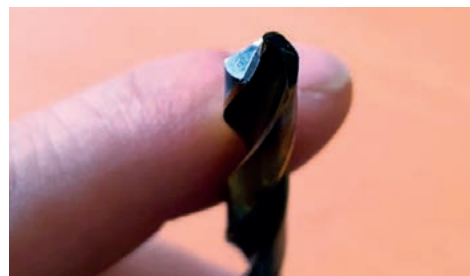

WMG P3.2

Segment: Agriculture machinery sub-contractor (India)
Component: Cast iron flywheel for tractor
Material: FG260 / GG25 (180 – 220 HB)
Coolant: Dry, no coolant
Application: Vertical CNC drilling, through holes without pecking
Previous results: Competitor drill had abnormal wear, usually after 260 holes the drill couldn't be used any further, or sometimes prematurely broke.

Result with R003: Dormer with TiN tip had better tool life compared to all competitors, finishing tests without breaking or with excessive wear after 264 holes, while using the same cutting parameters!

Dormer Pramet solution:

R0036.8

Machining data:

v_c	f_n	a_p
84 (25.6)	.005 (0.126)	.465 (30)

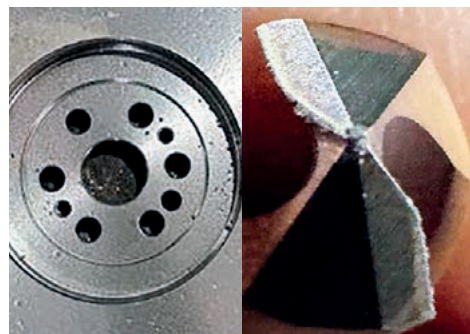

WMG K1.2

Segment: Powder metal parts producer (Canada)
Component: Fixture plates
Material: SAE 4340 / 1.6582 / 34CrNiMo6 (quenched alloy steel, 53 HRC)
Coolant: Yes, external, water soluble oil emulsion (8%)
Application: Manually driven pillar drill machine, locating dowel holes
Previous results: Competing drill needs lot of manual pressure to penetrate through the hardened material, it took 30 seconds to make the hole. The drill is worn out after 1 hole.

Result with R003: Dormer drill is able to penetrate the material in just 12 seconds with radically lower drilling effort, and it's still in good shape to continue on another hole.

Dormer Pramet solution:

R0031/4

Machining data:

v_c	f_n	a_p
95 (29)	.003 (0.08)	.299 (7.6)



WMG H3.1



DRILLING TOOLS

Segment: Hydraulic pumps parts sub-contractor (Italy)
Component: Hydraulic flow control valve
Material: 11SMnPb37 / 1.0737 (Free machining steel, 145 HB)
Coolant: Yes, external, water soluble oil emulsion (8%)
Application: Bridgeport CNC drilling before M8 thread, 35 mm deep with pecking
Previous results: Competing premium drill has setup according to manufacturer's recommendation ($v_c = 64$ m/min, $f_n = 0.25$ mm/rev), but tool life of 2300 holes is not satisfactory.

Result with R003: Our drill outperforms competing premium drill by slightly better tool life and also productivity, proves to be the best cost-effective choice for the job!

Dormer Pramet solution:

R0036.8

Machining data:

v_c	f_n	a_p
315 (96)	.008 (0.2)	1.378 (35)

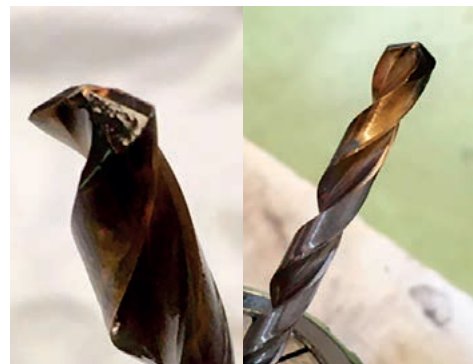

WMG P1.3

Segment: Machinery parts sub-contractor (China)
Component: Gearbox casing
Material: C45 / 1.0503 (Carbon steel, 225 HB)
Coolant: Yes, external, water soluble oil emulsion (8%)
Application: Vertical CNC drilling, through holes
Previous results: Long-term tests running to evaluate precisely cost per hole on most common job – steel case drilling.

Result with R003: Our drill with TiN tip achieved +15% longer tool life than similar competitor drill and a number of holes very close to a premium competitor drill.

Dormer Pramet solution:

R0032.5

Machining data:

v_c	f_n	a_p
295 (90)	.002 (0.05)	.157 (4)



WMG P2.1

Segment: General engineering, Automotive parts sub-contractor (Italy)
Component: Splined shaft coupling
Material: 11SMnPb37 / 1.0737 (Free machining steel, 145 HB)
Coolant: Yes, external, water soluble oil emulsion (8%)
Application: Doosan CNC lathe pre-drilling for M3 thread, 12 mm deep with pecking
Previous results: Competing uncoated carbide drill had stable tool life set on 1400 workpieces with $v_c = 27$ m/min. It was difficult to regrind the drill afterwards as it was almost destroyed.

Result with R003: Our TiN tip coated drill finished whole batch of 2000 workpieces with no visible wear with even higher cutting speed, improving productivity by 48%.

Dormer Pramet solution:

R0032.8

Machining data:

v_c	f_n	a_p
131 (40)	.003 (0.08)	.472 (12)

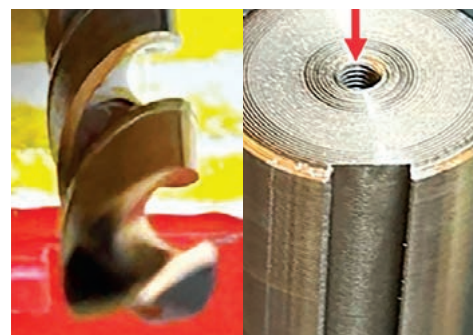

WMG P1.3

R003



Solid Carbide Jobber Drill, TiN tip Coated

Versatile entry-level drill with 120° point angle with four facet split point geometry for reduced thrust force and CTW flute construction for enhanced penetration rates. TiN tip coating improves performance and extends tool life. Suitable for both CNC machines and conventional machines across a wide range of workpiece materials.

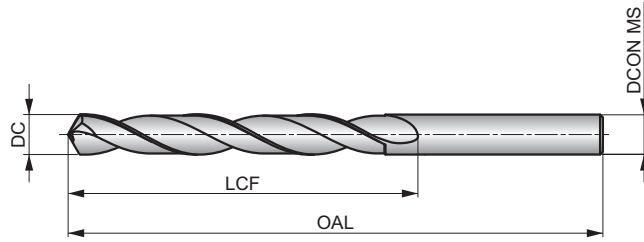

HM	DIN 338	4xD
120°	TiN-Tip	
λ 20-35°	R	DC h7

Workpiece material group suitability, starting values for cutting speed (ft/min) and feed Alpha Code. Tables with feed per revolution can be found starting from page 10.

P1.1 ■ 325 S	P1.2 ■ 364 S	P1.3 ■ 377 S	P2.1 ■ 279 S	P2.2 ■ 246 S	P2.3 ■ 217 S	P3.1 ■ 217 S	P3.2 ■ 174 S	P3.3 ■ 148 S	P4.1 ■ 131 S	P4.2 ■ 112 S	P4.3 ■ 89 S	K1.1 ■ 246 T	K1.2 ■ 184 T
K1.3 ■ 138 T	K2.1 ■ 223 T	K2.2 ■ 180 T	K2.3 ■ 144 T	K3.1 ■ 197 T	K3.2 ■ 151 T	K3.3 ■ 121 T	K4.1 ■ 180 T	K4.2 ■ 138 T	K4.3 ■ 102 T	K4.4 ■ 85 T	K4.5 ■ 72 T	K5.1 ■ 207 T	K5.2 ■ 154 T
K5.3 ■ 121 T	N1.1 ■ 492 V	N1.2 ■ 371 V	N1.3 ■ 246 V	N2.1 ■ 423 V	N2.2 ■ 381 V	N2.3 ■ 276 V	N3.1 ■ 1040 V	N3.2 ■ 623 V	N4.1 ■ 197 U	N4.2 ■ 328 U	H1.1 ■ 112 S	H2.1 ■ 166 S	H3.1 ■ 172 S

Product	DC	DC	DC	DC	DC	LCF	OAL	DCON MS	Pack Qty	MID
	(inch)	Letter size	Wire gauge size	(mm)	(inch)	(mm)	(mm)	(mm)		
R0031.0	-	-	-	1.00	.0394	12.0	34.0	1.00	1	8402812
R003N60	-	-	N60	1.02	.0400	12.0	34.0	1.02	1	8402752
R0031.1	-	-	-	1.10	.0433	14.0	36.0	1.10	1	8402813
R003N56	-	-	N56	1.18	.0465	16.0	38.0	1.18	1	8402756
R0033/64	3/64	-	-	1.19	.0469	16.0	38.0	1.19	1	8402619
R0031.2	-	-	-	1.20	.0472	16.0	38.0	1.20	1	8402814
R0031.3	-	-	-	1.30	.0512	16.0	38.0	1.30	1	8402815
R003N54	-	-	N54	1.40	.0550	18.0	40.0	1.40	1	8402758
R0031.4	-	-	-	1.40	.0551	18.0	40.0	1.40	1	8402816
R0031.5	-	-	-	1.50	.0591	18.0	40.0	1.50	1	8402817
R003N53	-	-	N53	1.51	.0595	20.0	43.0	1.51	1	8402759
R0031/16	1/16	-	-	1.59	.0625	20.0	43.0	1.59	1	8402690
R0031.6	-	-	-	1.60	.0630	20.0	43.0	1.60	1	8402818
R003N52	-	-	N52	1.61	.0635	20.0	43.0	1.61	1	8402760
R0031.7	-	-	-	1.70	.0669	20.0	43.0	1.70	1	8402819
R003N51	-	-	N51	1.70	.0670	22.0	46.0	1.70	1	8402761
R003N50	-	-	N50	1.78	.0700	22.0	46.0	1.78	1	8402762
R0031.8	-	-	-	1.80	.0709	22.0	46.0	1.80	1	8402820
R0031.9	-	-	-	1.90	.0748	22.0	46.0	1.90	1	8402821
R003N48	-	-	N48	1.93	.0760	24.0	49.0	1.93	1	8402764
R0035/64	5/64	-	-	1.98	.0781	24.0	49.0	1.98	1	8402691
R003N47	-	-	N47	1.99	.0785	24.0	49.0	1.99	1	8402765
R0032.0	-	-	-	2.00	.0787	24.0	49.0	2.00	1	8402822
R003N46	-	-	N46	2.06	.0810	24.0	49.0	2.06	1	8402766
R0032.1	-	-	-	2.10	.0827	24.0	49.0	2.10	1	8402823
R003N44	-	-	N44	2.18	.0860	27.0	53.0	2.18	1	8402768

Product	DC	DC	DC	DC	DC	LCF	OAL	DCON MS	Pack Qty	MID
	(inch)	Letter size	Wire gauge size	(mm)	(inch)	(mm)	(mm)	(mm)		
R0032.2	-	-	-	2.20	.0866	27.0	53.0	2.20	1	8402824
R003N43	-	-	N43	2.26	.0890	27.0	53.0	2.26	1	8402769
R0032.3	-	-	-	2.30	.0906	27.0	53.0	2.30	1	8402825
R0033/32	3/32	-	-	2.38	.0937	30.0	57.0	2.38	1	8402692
R0032.4	-	-	-	2.40	.0945	30.0	57.0	2.40	1	8402826
R003N41	-	-	N41	2.44	.0960	30.0	57.0	2.44	1	8402771
R0032.5	-	-	-	2.50	.0984	30.0	57.0	2.50	1	8402827
R003N39	-	-	N39	2.53	.0995	30.0	57.0	2.53	1	8402773
R003N38	-	-	N38	2.58	.1015	30.0	57.0	2.58	1	8402774
R0032.6	-	-	-	2.60	.1024	30.0	57.0	2.60	1	8402828
R003N37	-	-	N37	2.64	.1040	30.0	57.0	2.64	1	8402775
R0032.7	-	-	-	2.70	.1063	33.0	61.0	2.70	1	8402829
R003N36	-	-	N36	2.71	.1065	33.0	61.0	2.71	1	8402776
R0037/64	7/64	-	-	2.78	.1094	33.0	61.0	2.78	1	8402693
R0032.8	-	-	-	2.80	.1102	33.0	61.0	2.80	1	8402830
R003N33	-	-	N33	2.87	.1130	33.0	61.0	2.87	1	8402779
R0032.9	-	-	-	2.90	.1142	33.0	61.0	2.90	1	8402831
R003N32	-	-	N32	2.95	.1160	33.0	61.0	2.95	1	8402780
R0033.0	-	-	-	3.00	.1181	33.0	61.0	3.00	1	8402832
R003N31	-	-	N31	3.05	.1200	36.0	65.0	3.05	1	8402781
R0033.1	-	-	-	3.10	.1220	36.0	65.0	3.10	1	8402833
R0031/8	1/8	-	-	3.17	.1250	36.0	65.0	3.17	1	8402694
R0033.2	-	-	-	3.20	.1260	36.0	65.0	3.20	1	8402834
R0033.3	-	-	-	3.30	.1299	36.0	65.0	3.30	1	8402835
R0033.4	-	-	-	3.40	.1339	39.0	70.0	3.40	1	8402836
R003N29	-	-	N29	3.45	.1360	39.0	70.0	3.45	1	8402783

R023



Solid Carbide Stub Drill, TiN tip Coated

Versatile entry-level drill with 120° point angle with four facet split point geometry for reduced thrust force and CTW flute construction for enhanced penetration rates. TiN tip coating improves performance and extends tool life. Suitable for both CNC machines and conventional machines across a wide range of workpiece materials.

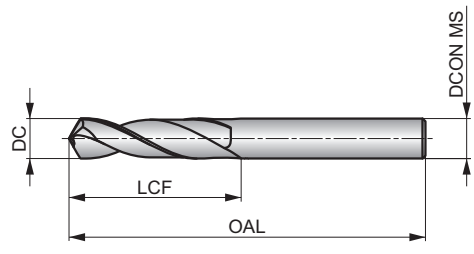

HM	DIN 6539	2.5×D
120°	TiN-Tip	
λ20-35°	R	DC h7

Workpiece material group suitability, starting values for cutting speed (ft/min) and feed Alpha Code. Tables with feed per revolution can be found starting from page 10.

P1.1	P1.2	P1.3	P2.1	P2.2	P2.3	P3.1	P3.2	P3.3	P4.1	P4.2	P4.3	K1.1	K1.2
■ 325 T	■ 364 T	■ 377 T	■ 279 T	■ 246 T	■ 217 T	■ 217 T	■ 174 T	■ 148 T	■ 131 S	■ 112 S	■ 89 S	■ 246 U	■ 184 U
K1.3	K2.1	K2.2	K2.3	K3.1	K3.2	K3.3	K4.1	K4.2	K4.3	K4.4	K4.5	K5.1	K5.2
■ 138 U	■ 223 U	■ 180 U	■ 144 U	■ 197 U	■ 151 U	■ 121 U	■ 180 T	■ 138 T	■ 102 T	■ 85 T	■ 72 T	■ 207 U	■ 154 U
K5.3	N1.1	N1.2	N1.3	N2.1	N2.2	N2.3	N3.1	N3.2	N4.1	N4.2	H1.1	H2.1	H3.1
■ 121 U	■ 492 W	■ 371 W	■ 246 W	■ 423 W	■ 381 W	■ 276 W	■ 1040 W	■ 623 W	■ 197 V	■ 328 V	■ 112 S	■ 166 S	■ 72 S

Product	DC	DC	LCF	OAL	DCON MS	Pack Qty	MID
	(mm)	(inch)					
R0231.0	1.00	.0394	6.0	26.0	1.00	1	8402970
R0231.1	1.10	.0433	7.0	28.0	1.10	1	8402971
R0231.2	1.20	.0472	8.0	30.0	1.20	1	8402972
R0231.3	1.30	.0512	8.0	30.0	1.30	1	8402973
R0231.4	1.40	.0551	9.0	32.0	1.40	1	8402974
R0231.5	1.50	.0591	9.0	32.0	1.50	1	8402975
R0231.6	1.60	.0630	10.0	34.0	1.60	1	8402976
R0231.7	1.70	.0669	10.0	34.0	1.70	1	8402977
R0231.8	1.80	.0709	11.0	36.0	1.80	1	8402978
R0231.9	1.90	.0748	11.0	36.0	1.90	1	8402979
R0232.0	2.00	.0787	12.0	38.0	2.00	1	8402980
R0232.1	2.10	.0827	12.0	38.0	2.10	1	8402981
R0232.2	2.20	.0866	13.0	40.0	2.20	1	8402982
R0232.3	2.30	.0906	13.0	40.0	2.30	1	8402983
R0232.4	2.40	.0945	14.0	43.0	2.40	1	8402984
R0232.5	2.50	.0984	14.0	43.0	2.50	1	8402985
R0232.6	2.60	.1024	14.0	43.0	2.60	1	8402986
R0232.7	2.70	.1063	16.0	46.0	2.70	1	8402987
R0232.8	2.80	.1102	16.0	46.0	2.80	1	8402988
R0232.9	2.90	.1142	16.0	46.0	2.90	1	8402989
R0233.0	3.00	.1181	16.0	46.0	3.00	1	8402990
R0233.1	3.10	.1220	18.0	49.0	3.10	1	8402991
R0233.2	3.20	.1260	18.0	49.0	3.20	1	8402992
R0233.3	3.30	.1299	18.0	49.0	3.30	1	8402993
R0233.4	3.40	.1339	20.0	52.0	3.40	1	8402994
R0233.5	3.50	.1378	20.0	52.0	3.50	1	8402995

Product	DC	DC	LCF	OAL	DCON MS	Pack Qty	MID
	(mm)	(inch)					
R0233.6	3.60	.1417	20.0	52.0	3.60	1	8402996
R0233.7	3.70	.1457	20.0	52.0	3.70	1	8402997
R0233.8	3.80	.1496	22.0	55.0	3.80	1	8402998
R0233.9	3.90	.1535	22.0	55.0	3.90	1	8402999
R0234.0	4.00	.1575	22.0	55.0	4.00	1	8403000
R0234.1	4.10	.1614	22.0	55.0	4.10	1	8403001
R0234.2	4.20	.1654	22.0	55.0	4.20	1	8403002
R0234.3	4.30	.1693	24.0	58.0	4.30	1	8403003
R0234.4	4.40	.1732	24.0	58.0	4.40	1	8403004
R0234.5	4.50	.1772	24.0	58.0	4.50	1	8403005
R0234.6	4.60	.1811	24.0	58.0	4.60	1	8403006
R0234.7	4.70	.1850	24.0	58.0	4.70	1	8403007
R0234.8	4.80	.1890	26.0	62.0	4.80	1	8403008
R0234.9	4.90	.1929	26.0	62.0	4.90	1	8403009
R0235.0	5.00	.1969	26.0	62.0	5.00	1	8403010
R0235.1	5.10	.2008	26.0	62.0	5.10	1	8403011
R0235.2	5.20	.2047	26.0	62.0	5.20	1	8403012
R0235.3	5.30	.2087	26.0	62.0	5.30	1	8403013
R0235.4	5.40	.2126	28.0	66.0	5.40	1	8403014
R0235.5	5.50	.2165	28.0	66.0	5.50	1	8403015
R0235.6	5.60	.2205	28.0	66.0	5.60	1	8403016
R0235.7	5.70	.2244	28.0	66.0	5.70	1	8403017
R0235.8	5.80	.2283	28.0	66.0	5.80	1	8403018
R0235.9	5.90	.2323	28.0	66.0	5.90	1	8403019
R0236.0	6.00	.2362	28.0	66.0	6.00	1	8403020
R0236.1	6.10	.2402	31.0	70.0	6.10	1	8403021



Product	DC (mm)	DC (inch)	LCF (mm)	OAL (mm)	DCON MS (mm)	Pack Qty	MID
R0236.2	6.20	.2441	31.0	70.0	6.20	1	8403022
R0236.3	6.30	.2480	31.0	70.0	6.30	1	8403023
R0236.4	6.40	.2520	31.0	70.0	6.40	1	8403024
R0236.5	6.50	.2559	31.0	70.0	6.50	1	8403025
R0236.6	6.60	.2598	31.0	70.0	6.60	1	8403026
R0236.7	6.70	.2638	31.0	70.0	6.70	1	8403027
R0236.8	6.80	.2677	34.0	74.0	6.80	1	8403028
R0236.9	6.90	.2717	34.0	74.0	6.90	1	8403029
R0237.0	7.00	.2756	34.0	74.0	7.00	1	8403030
R0237.1	7.10	.2795	34.0	74.0	7.10	1	8403031
R0237.2	7.20	.2835	34.0	74.0	7.20	1	8403032
R0237.3	7.30	.2874	34.0	74.0	7.30	1	8403033
R0237.4	7.40	.2913	34.0	74.0	7.40	1	8403034
R0237.5	7.50	.2953	34.0	74.0	7.50	1	8403035
R0237.6	7.60	.2992	37.0	79.0	7.60	1	8403036
R0237.7	7.70	.3031	37.0	79.0	7.70	1	8403037
R0237.8	7.80	.3071	37.0	79.0	7.80	1	8403038
R0237.9	7.90	.3110	37.0	79.0	7.90	1	8403039
R0238.0	8.00	.3150	37.0	79.0	8.00	1	8403040
R0238.1	8.10	.3189	37.0	79.0	8.10	1	8403041
R0238.2	8.20	.3228	37.0	79.0	8.20	1	8403042
R0238.3	8.30	.3268	37.0	79.0	8.30	1	8403043

Product	DC (mm)	DC (inch)	LCF (mm)	OAL (mm)	DCON MS (mm)	Pack Qty	MID
R0238.4	8.40	.3307	37.0	79.0	8.40	1	8403044
R0238.5	8.50	.3346	37.0	79.0	8.50	1	8403045
R0238.6	8.60	.3386	40.0	84.0	8.60	1	8403046
R0238.7	8.70	.3425	40.0	84.0	8.70	1	8403047
R0238.8	8.80	.3465	40.0	84.0	8.80	1	8403048
R0238.9	8.90	.3504	40.0	84.0	8.90	1	8403049
R0239.0	9.00	.3543	40.0	84.0	9.00	1	8403050
R0239.1	9.10	.3583	40.0	84.0	9.10	1	8403051
R0239.2	9.20	.3622	40.0	84.0	9.20	1	8403052
R0239.3	9.30	.3661	40.0	84.0	9.30	1	8403053
R0239.4	9.40	.3701	40.0	84.0	9.40	1	8403054
R0239.5	9.50	.3740	40.0	84.0	9.50	1	8403055
R0239.6	9.60	.3780	43.0	89.0	9.60	1	8403056
R0239.7	9.70	.3819	43.0	89.0	9.70	1	8403057
R0239.8	9.80	.3858	43.0	89.0	9.80	1	8403058
R0239.9	9.90	.3898	43.0	89.0	9.90	1	8403059
R02310.0	10.00	.3937	43.0	89.0	10.00	1	8403060
R02310.2	10.20	.4016	43.0	89.0	10.20	1	8403061
R02310.5	10.50	.4134	43.0	89.0	10.50	1	8403062
R02311.0	11.00	.4331	47.0	95.0	11.00	1	8403063
R02311.5	11.50	.4528	47.0	95.0	11.50	1	8403064
R02312.0	12.00	.4724	51.0	102.0	12.00	1	8403065



DRILLING FEED RATE CHART

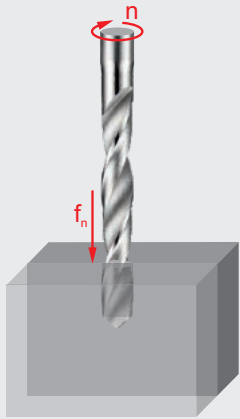

Feed per revolution (f_n in mm/rev)
Depending on the working conditions it might be necessary to adjust these values $\pm 25\%$.

How to use this table to find the feed per revolution (f_n):

1. Find your Alpha Code on the product page (example: 197 U, "U" is the Alpha Code).
2. Find the closest diameter for your cutting application in the top row of the table.
3. Find your Alpha Code in the left column of the table.
4. The intersection (cell) of the Diameter and Alpha Code is the feed per revolution (f_n).

DRILLING FEED RATE CHART (inch/rev)

		\varnothing DC															
		1/32" 1 mm	3/32" 2 mm	1/8" 3 mm	5/32" 4 mm	3/16" 5 mm	1/4" 6 mm	5/16" 8 mm	3/8" 10 mm	1/2" 12 mm	9/16" 15 mm	5/8" 16 mm	3/4" 20 mm	1" 25 mm	1.1/8" 30 mm	1.5/8" 40 mm	2" 50 mm
Feed rates (inch/rev)	S	.0003	.0006	.0008	.0010	.0012	.0015	.0020	.0031	.0039	.0048	.0051	.0059	.0070	.0070	.0090	–
	T	.0006	.0011	.0016	.0020	.0024	.0028	.0035	.0043	.0051	.0063	.0067	.0075	.0080	.0090	.0100	–
	U	.0010	.0019	.0028	.0031	.0035	.0042	.0055	.0067	.0079	.0088	.0091	.0094	.0110	.0120	.0140	–
	V	.0015	.0027	.0039	.0045	.0051	.0060	.0079	.0098	.0110	.0122	.0126	.0134	.0160	.0170	.0200	–
	W	.0019	.0035	.0051	.0059	.0067	.0079	.0102	.0130	.0150	.0165	.0169	.0177	.0190	.0190	.0200	–
	X	.0022	.0041	.0059	.0071	.0083	.0098	.0130	.0165	.0189	.0210	.0217	.0228	–	–	–	–
	Y	.0027	.0049	.0071	.0087	.0102	.0125	.0169	.0217	.0276	.0276	.0276	.0291	–	–	–	–
	Z	.0037	.0068	.0098	.0128	.0157	.0210	.0315	.0394	.0433	.0463	.0472	.0472	–	–	–	–

DRILLING FEED RATE CHART (mm/rev)

		\varnothing DC (mm)																		
		0.15	0.50	1.00	2.00	3.00	4.00	5.00	6.00	8.00	10.0	12.0	15.0	16.0	20.0	25.0	30.0	40.0	50.0	100.0
Feed rates (mm/rev)	S	0.002	0.004	0.008	0.014	0.020	0.025	0.030	0.037	0.050	0.080	0.100	0.123	0.130	0.150	0.170	0.190	0.220	0.240	–
	T	0.004	0.008	0.015	0.028	0.040	0.050	0.060	0.070	0.090	0.110	0.130	0.160	0.170	0.190	0.210	0.230	0.260	0.275	–
	U	0.007	0.013	0.026	0.048	0.070	0.080	0.090	0.107	0.140	0.170	0.200	0.223	0.230	0.240	0.270	0.300	0.360	0.375	–
	V	0.010	0.019	0.038	0.069	0.100	0.115	0.130	0.153	0.200	0.250	0.280	0.310	0.320	0.340	0.400	0.440	0.510	0.530	–
	W	0.012	0.025	0.049	0.089	0.130	0.150	0.170	0.200	0.260	0.330	0.380	0.418	0.430	0.450	0.470	0.490	0.520	0.540	–
	X	0.014	0.028	0.056	0.103	0.150	0.180	0.210	0.250	0.330	0.420	0.480	0.533	0.550	0.580	–	–	–	–	–
	Y	0.017	0.034	0.068	0.124	0.180	0.220	0.260	0.317	0.430	0.550	0.700	0.700	0.700	0.740	–	–	–	–	–
	Z	0.024	0.047	0.094	0.172	0.250	0.325	0.400	0.533	0.800	1.000	1.100	1.175	1.200	1.200	–	–	–	–	–



**E697
E698**

HIGHLY PRODUCTIVE MULTI APPLICATION TAPS (DIN/ANSI)

INTRODUCTION



Introducing Dormer E69. DIN/ANSI taps – the epitome of versatility and performance. Engineered with a specific geometry to conquer medium to high strength materials while preventing oversized threads in softer ones. The modified edge treatment ensures a long tool life with consistent results, and the 3D Radii flute profile guarantees precision and process security. With a TiCN coating for wear resistance and a unique powder metallurgy substrate, Dormer E69. taps deliver high performance without compromise.





E697(UNC)

- For through holes only
- Standard DIN 2184-1
- UNC range:
No. 8-32 – 1/2”-13



E697(UNF)

- For through holes only
- Standard DIN 2184-1
- UNF range:
1/4”-28 – 1/2”-20



E697(M)

- For through holes only
- Standard DIN 371 / 376
- Metric range: M3 – M30



E697(MF)

- For through holes only
- Standard DIN 374
- Metric Fine range:
M8x1 – M20x1.5



THREADING TOOLS

FEATURES AND BENEFITS

Versatile geometry prevents both clamping in medium to high strength materials, and oversized threads in soft materials.



EXCELLENT IN STEELS
and versatile for a variety of other materials.

Modified edge treatment and rounding increases cutting edge stability and reduces the risk of edge chipping.



EXTENDED TOOL LIFE
and long term consistency.

3-Radii flute profile provides maximum control of the cutting properties and secures proper swarf flow.



HIGH PROCESS RELIABILITY
secured by nesting prevention.

TiCN coating grants high wear resistance combined with low coefficient of friction.



COLD WELDING PROTECTION
throughout the whole life span.

Unique Powder Metallurgy HSS-E PM substrate provides excellent combination of toughness and edge hardness.



HIGH PERFORMANCE
without compromise on tool life.



DIN



DIN standard taps also available!



JIS



JIS standard taps also available!



E698(UNC)

- Primarily for blind holes
- Standard DIN 2184-1
- UNC range:
No. 8-32 – 1/2" -13



E698(UNF)

- Primarily for blind holes
- Standard DIN 2184-1
- UNF range:
1/4" -28 – 1/2" -20



E698(M)

- Primarily for blind holes
- Standard DIN 371 / 376
- Metric range: M3 – M30



E698(MF)

- Primarily for blind holes
- Standard DIN 374
- Metric Fine range:
M8x1 – M20x1.5



E69. HIGHLY PRODUCTIVE MULTI APPLICATION TAPS (DIN/ANSI)

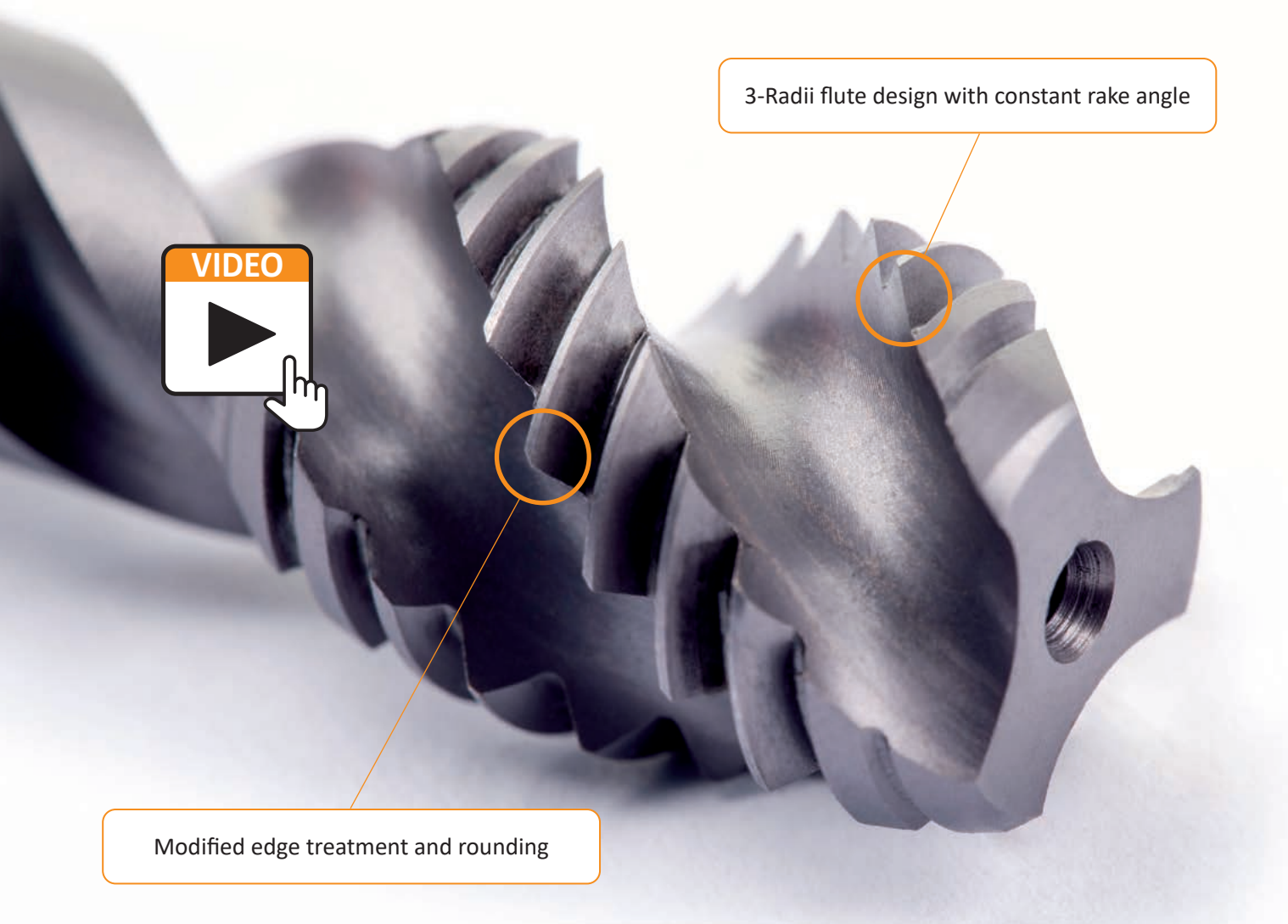

3-Radii flute design with constant rake angle



Modified edge treatment and rounding

SUCCESS STORY – E698

Segment: General Engineering (Czech republic)
Component: Hydraulic circuit parts
Material: 42CrMo4 / EN 10083 (Alloy steel, 250 HB)
Coolant: Yes, external, water soluble oil emulsion (~8%)
Application: Blind hole threading of M6 at 2.5xD, pre-drilled Ø 5.1 mm hole is 21 mm deep and made by solid carbide drill. Run in Tajmac MCFV 1060 CNC using a Tapmatic SynchroFlex SFT II75 tap holder.
Previous results: Serious problems caused by nesting, an average of 1000 threads was reached current taps. The best alternative competitor tap improved tool life to 1353 threads in average, but nesting problems still remained frequent.

Dormer Pramet solution:

E698M6

Machining data:	
v_c	td
49 (15)	.591 (15)

Result with E698: Our new tap design reached 1645 threads in average (+22%) with higher level of process security and limited nesting, which sum-up in improved productivity!

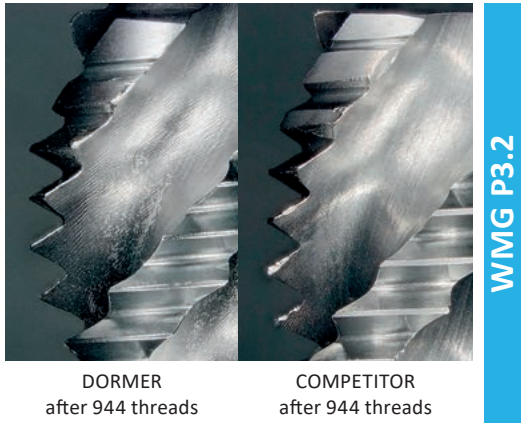

Thread form (THFT)								
Basic standard group (BSG)	DIN ANSI	DIN ANSI	DIN ANSI	DIN ANSI	DIN ANSI	DIN ANSI	DIN ANSI	DIN ANSI
Thread tolerance class (TCTR)	2BX	2BX	6HX	6HX	2BX	2BX	6HX	6HX
Threading application								
Usable length (ULDR)	2.5×D	2.5×D	2.5×D	2.5×D	2.5×D	2.5×D	2.5×D	2.5×D
Material code (BMC)	HSS-E PM	HSS-E PM	HSS-E PM	HSS-E PM	HSS-E PM	HSS-E PM	HSS-E PM	HSS-E PM
Tap chamfer style (TCS)	B 3.5-5	B 3.5-5	B 3.5-5	B 3.5-5	C 2-3	C 2-3	C 2-3	C 2-3
Flute Geometry (FDC)								
Flute helix angle (FHA)					λ 48°	λ 48°	λ 48°	λ 48°
Hand (Cutting direction)								
Coating								

Product Family Code	E697(UNC)	E697(UNF)	E697(M)	E697(MF)	E698(UNC)	E698(UNF)	E698(M)	E698(MF)
PSF cutting diameters range	No. 4 – 1"	No. 10 – 1"	M3 – M16	M8 – M16	No. 4 – 1"	No. 10 – 1"	M3 – M16	M8 – M16

P	P1	■	■	■	■	■	■	■
	P2	■	■	■	■	■	■	■
	P3	■	■	■	■	■	■	■
	P4	■	■	■	■	■	■	■
M	M1	■	■	■	■	■	■	■
	M2	■	■	■	■	■	■	■
	M3	■	■	■	■	■	■	■
	M4	▣	▣	▣	▣	▣	▣	▣
K	K1	▣	▣	▣	▣	▣	▣	▣
	K2	▣	▣	▣	▣	▣	▣	▣
	K3	▣	▣	▣	▣	▣	▣	▣
	K4	▣	▣	▣	▣	▣	▣	▣
	K5							
N	N1	▣	▣	▣	▣	▣	▣	▣
	N2	▣	▣	▣	▣	▣	▣	▣
	N3	▣	▣	▣	▣	▣	▣	▣
	N4	▣	▣	▣	▣	▣	▣	▣
	N5							
S	S1							
	S2							
	S3							
	S4							
H	H1							
	H2							
	H3							
	H4							



E697(UNC)



HSS-E-PM Spiral Point Tap, UNC, DIN/ANSI Standard, TiCN Coated

Machine tap for highly productive applications with spiral point for 2.5xD through holes only. Suited for machining a variety of work-materials. Unique TiCN coated HSS-E-PM substrate to offer superior abrasion resistance, higher cutting speeds, improve thread quality, reduced cycle times and longer tool-life.

	DIN ANSI	2BX
	2.5xD	HSS-E PM
B 3.5-5		

TDZ ≤ 3/8"

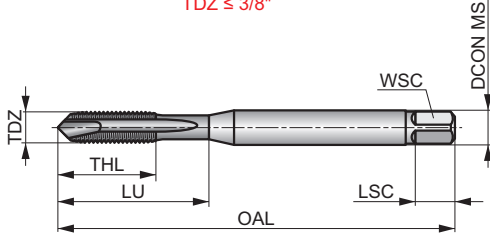

TDZ ≥ 1/2"

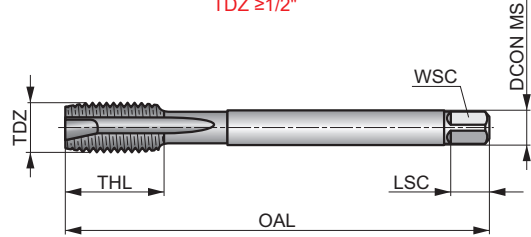

Workpiece material group suitability and starting values for cutting speed (ft/min).

P1.1 ■ 121	P1.2 ■ 138	P1.3 ■ 144	P2.1 ■ 108	P2.2 ■ 92	P2.3 ■ 82	P3.1 ■ 66	P3.2 ■ 52	P3.3 ■ 43	P4.1 ■ 39	P4.2 ■ 30	M1.1 ■ 49	M1.2 ■ 39	M2.1 ■ 43
M2.2 ■ 36	M3.1 ■ 30	M3.2 ■ 23	M3.3 ■ 20	M4.1 ■ 13	K1.1 ■ 66	K1.2 ■ 49	K1.3 ■ 36	K2.1 ■ 95	K2.2 ■ 75	K3.1 ■ 82	K3.2 ■ 62	K4.1 ■ 75	K4.2 ■ 56
N1.3 ■ 39	N2.1 ■ 121	N2.2 ■ 112	N2.3 ■ 79	N3.1 ■ 197	N3.2 ■ 118	N4.1 ■ 85							

Product	TDZ	TPI	OAL	THL	DCON MS	WSC	LSC	NOF	PHD	PHD	Limits	LU	Pack Qty	MID
			(inch)	(inch)	(inch)	(inch)	(inch)		(mm)	(inch)		(inch)		
E697UNC4X40	4	40	2.205	.354	.141	.108	.190	3	2.35	N43	H2	.709	1	8464264
E697UNC6X32	6	32	2.205	.433	.141	.108	.190	3	2.85	N36	H2	.787	1	8464265
E697UNC8X32	8	32	2.480	.512	.168	.129	.250	3	3.50	N29	H3	.827	1	8464266
E697UNC10X24	10	24	2.756	.551	.194	.150	.250	3	3.90	N25	H3	1.102	1	8464267
E697UNC1/4	1/4	20	3.150	.591	.255	.189	.310	3	5.10	N7	H5	.984	1	8464268
E697UNC5/16	5/16	18	3.543	.709	.318	.236	.380	3	6.60	F	H5	1.339	1	8464269
E697UNC3/8	3/8	16	3.937	.787	.381	.284	.440	3	8.00	5/16	H5	1.535	1	8464270
E697UNC1/2	1/2	13	4.331	.906	.367	.273	.440	3	10.80	27/64	H5	-	1	8464271
E697UNC5/8	5/8	11	4.331	.906	.480	.358	.560	3	13.50	17/32	H5	-	1	8464272
E697UNC3/4	3/4	10	4.921	1.181	.590	.439	.690	4	16.50	21/32	H5	-	1	8464273
E697UNC7/8	7/8	9	5.512	1.339	.697	.520	.750	4	19.50	49/64	H6	-	1	8464274
E697UNC1	1	8	6.299	1.417	.800	.597	.810	4	22.25	7/8	H6	-	1	8464275



E697(UNF)



HSS-E-PM Spiral Point Tap, UNF, DIN/ANSI Standard, TiCN Coated

Machine tap for highly productive applications with spiral point for 2.5xD through holes only. Suited for machining a variety of work-materials. Unique TiCN coated HSS-E-PM substrate to offer superior abrasion resistance, higher cutting speeds, improve thread quality, reduced cycle times and longer tool-life.

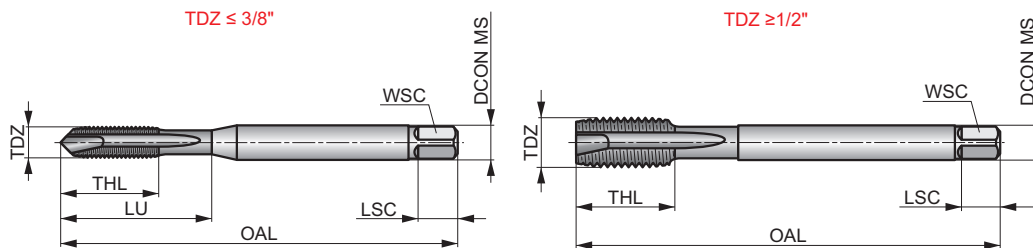

Workpiece material group suitability and starting values for cutting speed (ft/min).

P1.1 ■ 121	P1.2 ■ 138	P1.3 ■ 144	P2.1 ■ 108	P2.2 ■ 92	P2.3 ■ 82	P3.1 ■ 66	P3.2 ■ 52	P3.3 ■ 43	P4.1 ■ 39	P4.2 ■ 30	M1.1 ■ 49	M1.2 ■ 39	M2.1 ■ 43
M2.2 ■ 36	M3.1 ■ 30	M3.2 ■ 23	M3.3 ■ 20	M4.1 ■ 13	K1.1 ■ 66	K1.2 ■ 49	K1.3 ■ 36	K2.1 ■ 95	K2.2 ■ 75	K3.1 ■ 82	K3.2 ■ 62	K4.1 ■ 75	K4.2 ■ 56
N1.3 ■ 39	N2.1 ■ 121	N2.2 ■ 112	N2.3 ■ 79	N3.1 ■ 197	N3.2 ■ 118	N4.1 ■ 85							

Product	TDZ	TPI	OAL	THL	DCON MS	WSC	LSC	NOF	PHD	PHD	Limits	LU	Pack Qty	MID
			(inch)	(inch)	(inch)	(inch)	(inch)		(mm)	(inch)		(inch)		
E697UNF10X32	10	32	2.756	.551	.194	.150	.250	3	4.10	N21	H3	1.102	1	8464288
E697UNF1/4	1/4	28	3.150	.591	.255	.189	.310	3	5.50	N3	H4	.984	1	8464289
E697UNF5/16	5/16	24	3.543	.709	.318	.236	.380	3	6.90	I	H4	1.339	1	8464290
E697UNF3/8	3/8	24	3.937	.787	.381	.284	.440	3	8.50	Q	H4	1.476	1	8464291
E697UNF1/2	1/2	20	4.331	.906	.367	.273	.440	3	11.50	29/64	H5	-	1	8464292
E697UNF5/8	5/8	18	4.331	.906	.480	.358	.560	3	14.50	37/64	H5	-	1	8464293
E697UNF3/4	3/4	16	4.921	1.181	.590	.439	.690	4	17.50	11/16	H5	-	1	8464294
E697UNF7/8	7/8	14	5.512	1.339	.697	.520	.750	4	20.40	13/16	H6	-	1	8464295
E697UNF1	1	12	6.299	1.417	.800	.597	.810	4	23.25	59/64	H6	-	1	8464296

E697(M)



HSS-E-PM Spiral Point Tap, Metric, DIN/ANSI Standard, TiCN Coated

Machine tap for highly productive applications with spiral point for 2.5xD through holes only. Suited for machining a variety of work-materials. Unique TiCN coated HSS-E-PM substrate to offer superior abrasion resistance, higher cutting speeds, improve thread quality, reduced cycle times and longer tool-life.

	DIN ANSI	6HX
	2.5xD	HSS-E PM
B 3.5-5		

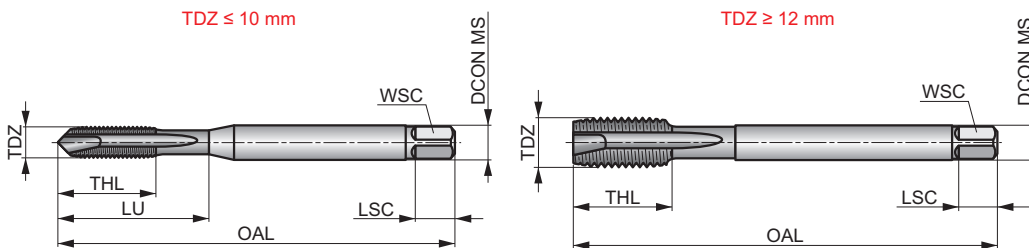

Workpiece material group suitability and starting values for cutting speed (ft/min).

P1.1 ■ 121	P1.2 ■ 138	P1.3 ■ 144	P2.1 ■ 108	P2.2 ■ 92	P2.3 ■ 82	P3.1 ■ 66	P3.2 ■ 52	P3.3 ▣ 43	P4.1 ■ 39	P4.2 ▣ 30	M1.1 ■ 49	M1.2 ■ 39	M2.1 ■ 43
M2.2 ■ 36	M3.1 ■ 30	M3.2 ■ 23	M3.3 ▣ 20	M4.1 ▣ 13	K1.1 ▣ 66	K1.2 ▣ 49	K1.3 ▣ 36	K2.1 ▣ 95	K2.2 ▣ 75	K3.1 ▣ 82	K3.2 ▣ 62	K4.1 ▣ 75	K4.2 ▣ 56
N1.3 ▣ 39	N2.1 ▣ 121	N2.2 ▣ 112	N2.3 ▣ 79	N3.1 ▣ 197	N3.2 ▣ 118	N4.1 ▣ 85							

Product	TDZ	TP	OAL	THL	DCON MS	WSC	LSC	NOF	PHD	PHD	Limits	LU	Pack Qty	MID
	(mm)	(mm)	(mm)	(mm)	(inch)	(inch)	(mm)		(mm)	(inch)		(mm)		
E697M3	3	0.50	56.0	9	.141	.108	5	3	2.50	N40	D3	18.00	1	8464234
E697M4	4	0.70	63.0	12	.168	.129	6	3	3.30	N30	D4	21.00	1	8464235
E697M5	5	0.80	70.0	13	.194	.150	6	3	4.20	N19	D4	25.00	1	8464236
E697M6	6	1.00	80.0	15	.255	.189	8	3	5.00	N9	D5	30.00	1	8464237
E697M8	8	1.25	90.0	18	.318	.236	10	3	6.80	H	D5	35.00	1	8464238
E697M10	10	1.50	100.0	20	.381	.284	11	3	8.50	Q	D6	39.00	1	8464239
E697M12	12	1.75	110.0	23	.367	.273	11	4	10.30	Y	D6	-	1	8464240
E697M16	16	2.00	110.0	23	.480	.358	14	4	14.00	35/64	D7	-	1	8464241



E697(MF)



HSS-E-PM Spiral Point Tap, Metric Fine, DIN/ANSI Standard, TiCN Coated

Machine tap for highly productive applications with spiral point for 2.5xD through holes only. Suited for machining a variety of work-materials. Unique TiCN coated HSS-E-PM substrate to offer superior abrasion resistance, higher cutting speeds, improve thread quality, reduced cycle times and longer tool-life.

	DIN ANSI	6HX
	2.5xD	HSS-E PM
B 3.5-5		

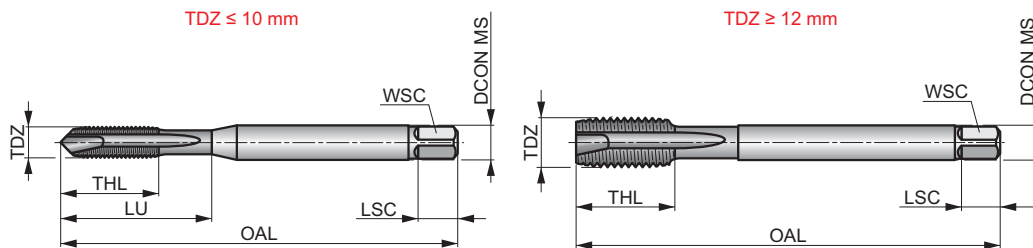

Workpiece material group suitability and starting values for cutting speed (ft/min).

P1.1 ■ 121	P1.2 ■ 138	P1.3 ■ 144	P2.1 ■ 108	P2.2 ■ 92	P2.3 ■ 82	P3.1 ■ 66	P3.2 ■ 52	P3.3 ▣ 43	P4.1 ■ 39	P4.2 ▣ 30	M1.1 ■ 49	M1.2 ■ 39	M2.1 ■ 43
M2.2 ■ 36	M3.1 ■ 30	M3.2 ■ 23	M3.3 ▣ 20	M4.1 ▣ 13	K1.1 ▣ 66	K1.2 ▣ 49	K1.3 ▣ 36	K2.1 ▣ 95	K2.2 ▣ 75	K3.1 ▣ 82	K3.2 ▣ 62	K4.1 ▣ 75	K4.2 ▣ 56
N1.3 ▣ 39	N2.1 ▣ 121	N2.2 ▣ 112	N2.3 ▣ 79	N3.1 ▣ 197	N3.2 ▣ 118	N4.1 ▣ 85							

Product	TDZ	TP	OAL	THL	DCON MS	WSC	LSC	NOF	PHD	PHD	Limits	LU	Pack Qty	MID
E697M8X1.0	8	1.00	90.0	18	.318	.236	10	3	7.00	J	D5	35.00	1	8464250
E697M10X1.0	10	1.00	90.0	20	.381	.284	11	3	9.00	T	D6	39.00	1	8464251
E697M10X1.25	10	1.25	100.0	20	.381	.284	11	3	8.80	11/32	D6	39.00	1	8464252
E697M12X1.25	12	1.25	100.0	21	.367	.273	11	4	10.80	27/64	D6	-	1	8464253
E697M12X1.5	12	1.50	100.0	21	.367	.273	11	4	10.50	Z	D6	-	1	8464254
E697M14X1.5	14	1.50	100.0	21	.429	.320	13	4	12.50	31/64	D7	-	1	8464255
E697M16X1.5	16	1.50	100.0	21	.480	.358	14	4	14.50	9/16	D7	-	1	8464256



E698(UNC)



HSS-E-PM Spiral Flute Tap, UNC, DIN/ANSI Standard, TiCN Coated

Machine tap for highly productive applications with spiral flute for 2.5xD blind holes. Suited for a variety of work-materials. Unique TiCN coated HSS-E-PM to offer superior abrasion resistance, higher cutting speeds, improve thread quality, reduced cycle times and longer tool-life. Recommended for synchronous feed tap holders.

	DIN ANSI	2BX
	2.5xD	HSS-E PM
		λ 48°

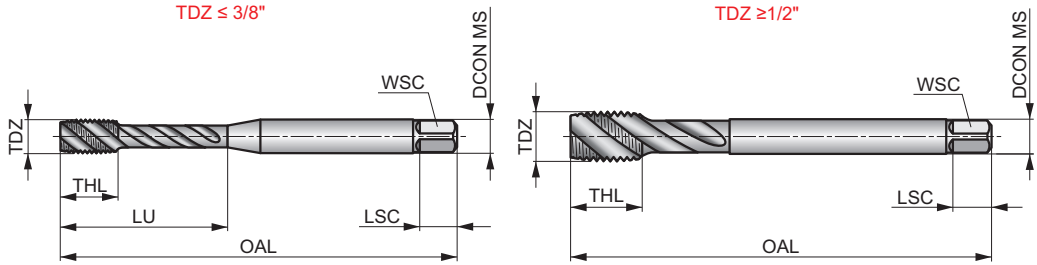

Workpiece material group suitability and starting values for cutting speed (ft/min).

P1.1 ■ 115	P1.2 ■ 131	P1.3 ■ 138	P2.1 ■ 102	P2.2 ■ 89	P2.3 ■ 79	P3.1 ■ 62	P3.2 ■ 49	P3.3 ■ 39	P4.1 ■ 36	P4.2 ■ 30	M1.1 ■ 46	M1.2 ■ 36	M2.1 ■ 39
M2.2 ■ 33	M3.1 ■ 30	M3.2 ■ 23	M3.3 ■ 20	M4.1 ■ 13	N1.3 ■ 36	N2.1 ■ 115	N2.2 ■ 105	N2.3 ■ 75	N3.1 ■ 197				

Product	TDZ	TPI	OAL	THL	DCON MS	WSC	LSC	NOF	PHD	PHD	Limits	LU	Pack Qty	MID
			(inch)	(inch)	(inch)	(inch)	(inch)		(mm)	(inch)		(inch)		
E698UNC4X40	4	40	2.205	.256	.141	.108	.190	3	2.35	N43	H2	.709	1	8464276
E698UNC6X32	6	32	2.205	.256	.141	.108	.190	3	2.85	N36	H2	.787	1	8464277
E698UNC8X32	8	32	2.480	.276	.168	.129	.250	3	3.50	N29	H3	.827	1	8464278
E698UNC10X24	10	24	2.756	.315	.194	.150	.250	3	3.90	N25	H3	1.102	1	8464279
E698UNC1/4	1/4	20	3.150	.394	.255	.189	.310	3	5.10	N7	H5	.984	1	8464280
E698UNC5/16	5/16	18	3.543	.472	.318	.236	.380	3	6.60	F	H5	1.339	1	8464281
E698UNC3/8	3/8	16	3.937	.591	.381	.284	.440	3	8.00	5/16	H5	1.535	1	8464282
E698UNC1/2	1/2	13	4.331	.709	.367	.273	.440	3	10.80	27/64	H5	—	1	8464283
E698UNC5/8	5/8	11	4.331	.787	.480	.358	.560	4	13.50	17/32	H5	—	1	8464284
E698UNC3/4	3/4	10	4.921	.984	.590	.439	.690	4	16.50	21/32	H5	—	1	8464285
E698UNC7/8	7/8	9	5.512	.984	.697	.520	.750	4	19.50	49/64	H6	—	1	8464286
E698UNC1	1	8	6.299	1.181	.800	.597	.810	4	22.25	7/8	H6	—	1	8464287



E698(UNF)



HSS-E-PM Spiral Flute Tap, UNF, DIN/ANSI Standard, TiCN Coated

Machine tap for highly productive applications with spiral flute for 2.5xD blind holes. Suited for a variety of work-materials. Unique TiCN coated HSS-E-PM to offer superior abrasion resistance, higher cutting speeds, improve thread quality, reduced cycle times and longer tool-life. Recommended for synchronous feed tap holders.

	DIN ANSI	2BX
	2.5xD	HSS-E-PM
C 2-3		λ 48°
R	TiCN	

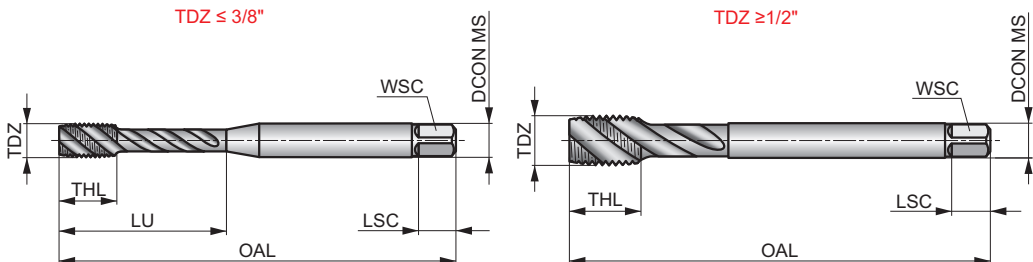

Workpiece material group suitability and starting values for cutting speed (ft/min).

P1.1 ■ 115	P1.2 ■ 131	P1.3 ■ 138	P2.1 ■ 102	P2.2 ■ 89	P2.3 ■ 79	P3.1 ■ 62	P3.2 ■ 49	P3.3 ▣ 39	P4.1 ■ 36	P4.2 ▣ 30	M1.1 ■ 46	M1.2 ■ 36	M2.1 ■ 39
M2.2 ■ 33	M3.1 ■ 30	M3.2 ■ 23	M3.3 ▣ 20	M4.1 ▣ 13	N1.3 ▣ 36	N2.1 ▣ 115	N2.2 ▣ 105	N2.3 ▣ 75	N3.1 ▣ 197				

Product	TDZ	TPI	OAL	THL	DCON MS	WSC	LSC	NOF	PHD	PHD	Limits	LU	Pack Qty	MID
			(inch)	(inch)	(inch)	(inch)	(inch)		(mm)	(inch)		(inch)		
E698UNF10X32	10	32	2.756	.315	.194	.150	.250	3	4.10	N21	H3	1.102	1	8464297
E698UNF1/4	1/4	28	3.150	.394	.255	.189	.310	3	5.50	N3	H4	.984	1	8464298
E698UNF5/16	5/16	24	3.543	.472	.318	.236	.380	3	6.90	I	H4	1.339	1	8464299
E698UNF3/8	3/8	24	3.937	.591	.381	.284	.440	3	8.50	Q	H4	1.476	1	8464300
E698UNF1/2	1/2	20	4.331	.709	.367	.273	.440	3	11.50	29/64	H5	-	1	8464301
E698UNF5/8	5/8	18	4.331	.787	.480	.358	.560	4	14.50	37/64	H5	-	1	8464302
E698UNF3/4	3/4	16	4.921	.984	.590	.439	.690	4	17.50	11/16	H5	-	1	8464303
E698UNF7/8	7/8	14	5.512	.984	.697	.520	.750	4	20.40	13/16	H6	-	1	8464304
E698UNF1	1	12	6.299	1.181	.800	.597	.810	4	23.25	59/64	H6	-	1	8464305



E698(M)



HSS-E-PM Spiral Flute Tap, Metric, DIN/ANSI Standard, TiCN Coated

Machine tap for highly productive applications with spiral flute for 2.5xD blind holes. Suited for a variety of work-materials. Unique TiCN coated HSS-E-PM to offer superior abrasion resistance, higher cutting speeds, improve thread quality, reduced cycle times and longer tool-life. Recommended for synchronous feed tap holders.

	DIN ANSI	6HX
	2.5xD	HSS-E PM
		λ 48°

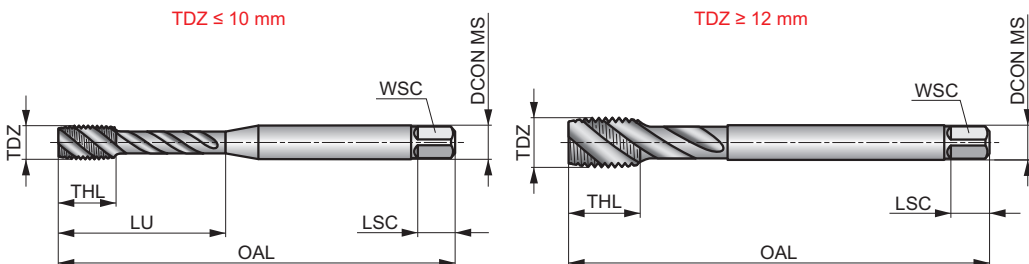

Workpiece material group suitability and starting values for cutting speed (ft/min).

P1.1 ■ 115	P1.2 ■ 131	P1.3 ■ 138	P2.1 ■ 102	P2.2 ■ 89	P2.3 ■ 79	P3.1 ■ 62	P3.2 ■ 49	P3.3 ■ 39	P4.1 ■ 36	P4.2 ■ 30	M1.1 ■ 46	M1.2 ■ 36	M2.1 ■ 39
M2.2 ■ 33	M3.1 ■ 30	M3.2 ■ 23	M3.3 ■ 20	M4.1 ■ 13	N1.3 ■ 36	N2.1 ■ 115	N2.2 ■ 105	N2.3 ■ 75	N3.1 ■ 197				

Product	TDZ	TP	OAL	THL	DCON MS	WSC	LSC	NOF	PHD	PHD	Limits	LU	Pack Qty	MID
	(mm)	(mm)	(mm)	(mm)	(inch)	(inch)	(mm)		(mm)	(inch)		(mm)		
E698M3	3	0.50	56.0	6	.141	.108	5	3	2.50	N40	D3	18.00	1	8464242
E698M4	4	0.70	63.0	7	.168	.129	6	3	3.30	N30	D4	21.00	1	8464243
E698M5	5	0.80	70.0	8	.194	.150	6	3	4.20	N19	D4	25.00	1	8464244
E698M6	6	1.00	80.0	10	.255	.189	8	3	5.00	N9	D5	30.00	1	8464245
E698M8	8	1.25	90.0	13	.318	.236	10	3	6.80	H	D5	35.00	1	8464246
E698M10	10	1.50	100.0	15	.381	.284	11	3	8.50	Q	D6	39.00	1	8464247
E698M12	12	1.75	110.0	18	.367	.273	11	3	10.30	Y	D6	–	1	8464248
E698M16	16	2.00	110.0	20	.480	.358	14	4	14.00	35/64	D7	–	1	8464249



E698(MF)



HSS-E-PM Spiral Flute Tap, Metric Fine, DIN/ANSI Standard, TiCN Coated

Machine tap for highly productive applications with spiral flute for 2.5xD blind holes. Suited for a variety of work-materials. Unique TiCN coated HSS-E-PM to offer superior abrasion resistance, higher cutting speeds, improve thread quality, reduced cycle times and longer tool-life. Recommended for synchronous feed tap holders.

	DIN ANSI	6HX
	2.5xD	HSS-E PM
C 2-3		λ 48°

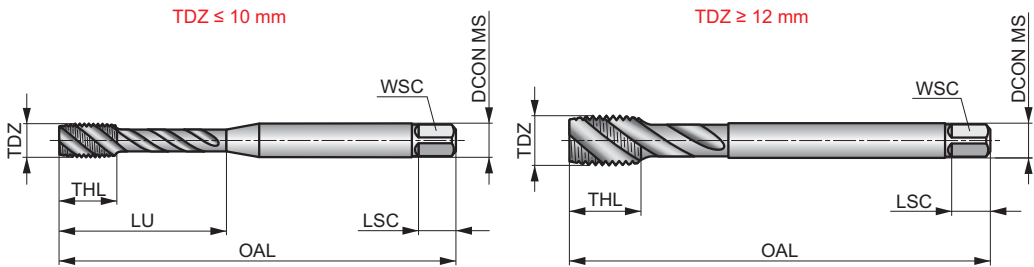

Workpiece material group suitability and starting values for cutting speed (ft/min).

P1.1 ■ 115	P1.2 ■ 131	P1.3 ■ 138	P2.1 ■ 102	P2.2 ■ 89	P2.3 ■ 79	P3.1 ■ 62	P3.2 ■ 49	P3.3 ▣ 39	P4.1 ■ 36	P4.2 ▣ 30	M1.1 ■ 46	M1.2 ■ 36	M2.1 ■ 39
M2.2 ■ 33	M3.1 ■ 30	M3.2 ■ 23	M3.3 ▣ 20	M4.1 ▣ 13	N1.3 ▣ 36	N2.1 ▣ 115	N2.2 ▣ 105	N2.3 ▣ 75	N3.1 ▣ 197				

Product	TDZ	TP	OAL	THL	DCON MS	WSC	LSC	NOF	PHD	PHD	Limits	LU	Pack Qty	MID
		(mm)	(mm)	(mm)	(inch)	(inch)	(mm)		(mm)	(inch)		(mm)		
E698M8X1.0	8	1.00	90.0	13	.318	.236	10	3	7.00	J	D5	35.00	1	8464257
E698M10X1.0	10	1.00	90.0	15	.381	.284	11	3	9.00	T	D6	39.00	1	8464258
E698M10X1.25	10	1.25	100.0	15	.381	.284	11	3	8.80	11/32	D6	39.00	1	8464259
E698M12X1.25	12	1.25	100.0	15	.367	.273	11	3	10.80	27/64	D6	-	1	8464260
E698M12X1.5	12	1.50	100.0	15	.367	.273	11	3	10.50	Z	D6	-	1	8464261
E698M14X1.5	14	1.50	100.0	15	.429	.320	13	3	12.50	31/64	D7	-	1	8464262
E698M16X1.5	16	1.50	100.0	15	.480	.358	14	4	14.50	9/16	D7	-	1	8464263



T8415 VERSATILE PVD TURNING GRADE

INTRODUCTION



Introducing the Pramet T8415, our cutting-edge PVD turning grade. Versatile across steels, stainless steels, and heat-resistant super alloys (HRSA), it minimizes friction with a top TiBN layer and optimizes performance in lighter cuts across many types of workpiece materials. With a wide chip-breaker range in positive and negative ISO inserts, the T8415 redefines turning performance and efficiency.



APPLICATION AREA OF PVD GRADES

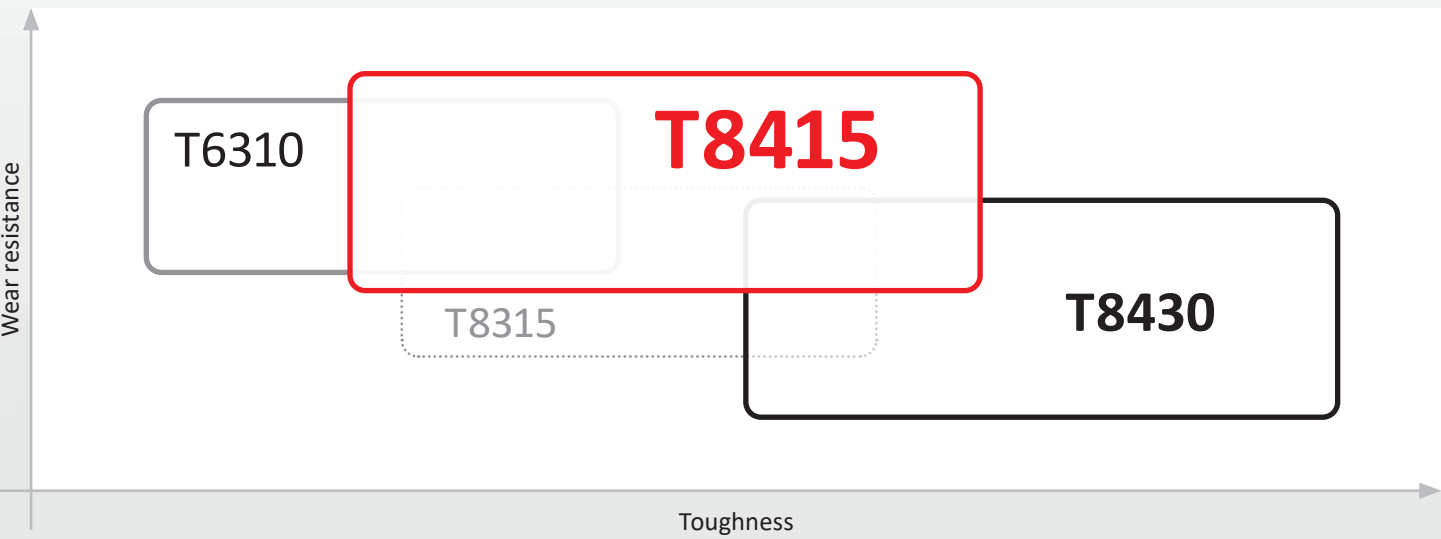



TURNING INSERTS

FEATURES AND BENEFITS

New generation multi-layered PVD coating combined with high-end sub-micron carbide grade.



VERSATILE USE

for a broad range of workpieces.

Unique TiBN sliding top layer reduces build-up edge.



IMPROVED SECURITY

in medium and high cutting speeds with coolant.

Thick TiN layer with low compressive residual stress.



LONG TOOL LIFE

even in adverse cutting conditions.

Hard AlTiN layer with newly developed composition.



HIGH WEAR RESISTANCE

against abrasive and thermal wear.

High-end ion cleaning improves adhesion of the coating to the substrate.



PROCESS REPEATABILITY

and long-term stability of tool life.

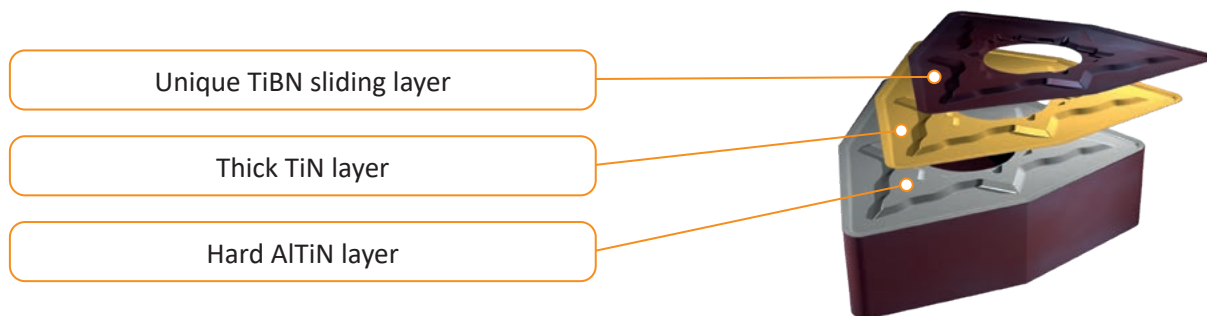

TECHNICAL INFORMATION

Grade code	Application area	Application	Feed	Cutting speed	Resistance to adverse working conditions	Coating	Colour	Substrate	Coolant benefit
T8415	P05 – P20	■				PVD		submicron H	++
	M05 – M20	■							
	K05 – K25	■							
	N05 – N25	▣							
	S05 – S15	■							
H05 – H15	■								

Grade description

A versatile, high performance turning grade primarily intended for steel machining, but well suitable for stainless steels and heat resistant super alloys (HRSA) too, possibly applicable for hardened steels. It is suitable for machining at wide range of cutting speeds, light to medium feeds and under good cutting conditions, preferably with coolant.



T8415

VERSATILE PVD TURNING GRADE

SUCCESS STORIES – T8415

Segment: Automotive parts sub-contractor (India)
Component: Slim intermediate shaft
Material: EN8 / C40 / 1.0511 (Carbon steel, 220 HB)
Coolant: Yes, water soluble oil emulsion (8%)
Application: Outer diameter semi-finish turning
Previous results: Customer had stable tool life at 160 workpieces per cutting edge with competitor insert, which was satisfactory at the time.

Results with T8415: One cutting edge of the Pramet insert has 120% tool life, but with an even higher feed rate, which boosted productivity to 125%!

Dormer Pramet solution:

DNMG 150608E-SM:T8415

Machining data:

v_c	f_n	a_p
820 (250)	.010 (0.25)	.020 (0.5)



WMG P2.2

Segment: Petrochemical industry sub-contractor (Brazil)
Component: Pump flange
Material: AISI 316 (Forged stainless steel, 210 HB)
Coolant: Yes, water soluble oil emulsion (12%)
Application: External turning with interruptions
Previous results: Competing inserts had problems keeping tool life at an acceptable level, especially with interrupted cutting that caused the insert to break suddenly.

Results with T8415: Our PVD inserts do not break during interrupted cuts and have 120% overall life than the second best competing insert tested!

Dormer Pramet solution:

WNMG 080408E-SM:T8415

Machining data:

v_c	f_n	a_p
180 (55)	.012 (0.3)	.118 (3.0)



WMG M3.2

Segment: Maintenance and repair sub-contractor (Brazil)
Component: Repair of press machine shaft with weld-on layer
Material: CrV weld (55 HRC)
Coolant: No
Application: Interrupted cut of weld-on layer with crust on top
Previous results: The competitors CVD grade had quite satisfactory results and a stable tool life ending at 10 minutes.

Results with T8415: We achieved almost triple the tool life compared to the competition, increasing from 10 to 28 minutes! The customer is thrilled with this result and can't wait to buy our insert and use it for such demanding jobs.

Dormer Pramet solution:

TNMG 160404E-FM:T8415

Machining data:

v_c	f_n	a_p
82 (25)	.006 (0.15)	.157 (4)

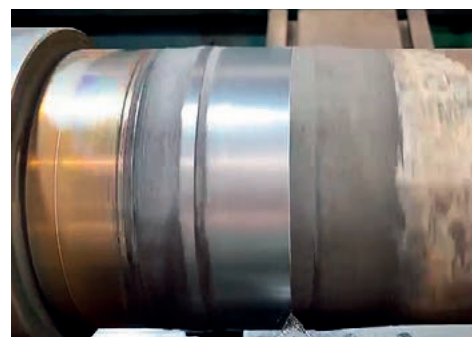

WMG H3.2



TURNING INSERTS

Segment: Automotive parts mass producer (Brazil)
Component: Trapezoidal connecting rod
Material: SAE 4140 (Alloy steel, 250 HB)
Coolant: Yes, water soluble oil emulsion (8%)
Application: Hole diameter boring
Previous results: The setup is very strict and all aspects of machining productivity vs. economy are taken into account. The competitor insert has tool life stability for 100 workpieces.

Dormer Pramet solution:

TCMT 110204E-FM:T8415

Machining data:

v_c	f_n	a_p
709 (216)	.003 (0.07)	.039 (1.0)



WMG P3.2

Results with T8415: After long-term testing, the Pramet insert confirms a stable tool life of 130 workpieces, which is 130% to a competing PVD insert of similar type!

Segment: Oil & gas industry parts producer (France)
Component: Shaft for extremely corrosive environment
Material: Inconel 718 (Ni-based HRSA, 36 HRC)
Coolant: Yes, water soluble oil emulsion (12%)
Application: Continuous longitudinal roughing
Previous results: The competing insert had a tool life set to 12 minutes for process safety. The customer needs to avoid sudden breakage because the workpiece is very expensive.

Dormer Pramet solution:

SNMG 120408E-SM:T8415

Machining data:

v_c	f_n	a_p
131 (40)	.010 (0.25)	.098 (2.5)



WMG S3.2

Results with T8415: Long-term repeated testing has shown that we are able to achieve double tool life with the same cutting parameters without any problem or sudden failure.

Segment: Chemical industry sub-contractor (Poland)
Component: Sleeve for chemicals pump shaft
Material: Hastelloy C-276 weld-on layer
Coolant: Yes, water soluble oil emulsion (8%)
Application: Continuous longitudinal semi-roughing
Previous results: All competing inserts failed to complete a single pass through the welded layer, which is 70 mm long. The best competitor lasts up to 30 mm, then burns out from the heat.

Dormer Pramet solution:

CNMG 120408E-NF:T8415

Machining data:

v_c	f_n	a_p
33 (10)	.005 – .006 (0.12 – 0.15)	.039 (1.0)

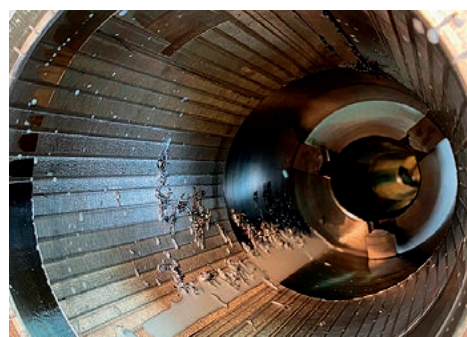

WMG S3.2

Results with T8415: Long-term repeated testing has shown that we are able to achieve double tool life with the same cutting parameters without any problem or sudden failure.



ISO INSERTS POSITIVE – CHIPBREAKER NAVIGATOR

Very unstable working conditions









Unstable working conditions



Stable working conditions



Thin-walled and slim workpieces

-  1st choice (ISO-P)
-  Possible use (ISO-P)
-  1st choice (ISO-M)
-  Possible use (ISO-M)
-  1st choice (ISO-K)
-  Possible use (ISO-K)
-  1st choice (ISO-S)
-  Possible use (ISO-S)
-  1st choice (ISO-H)
-  Possible use (ISO-H)

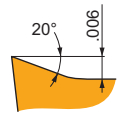
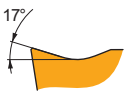
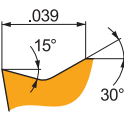

					
	.002 – .008 in/rev 0.05 – 0.2 mm/rev		.008 – .016 in/rev 0.2 – 0.4 mm/rev	.016 – .039 in/rev 0.4 – 1.0 mm/rev	> .039 in/rev > 1.0 mm/rev
	.002 – .079 in 0.05 – 2 mm		.078 – .157 in 2 – 4 mm	.157 – .394 in 4 – 10 mm	> .394 in > 10 mm

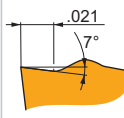
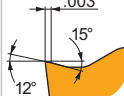
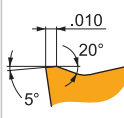
SF3		Highly positive precisely ground design for fine finishing continuous cuts, suitable for super alloys, stainless steels and non-ferrous materials, potentially steel, cast irons and hard materials.
NF2		Positive design for fine finishing up to medium continuous cuts, suitable for stainless steels and super alloys, potentially steels.
UR		Positive design for fine finishing up to semi-roughing continuous cuts, suitable for steels, potentially stainless steels and cast irons.

FF2		Slightly positive design for fine finishing up to medium continuous cuts, suitable for steels, potentially cast irons.
FM		Versatile design for moderately interrupted finishing cuts up to continuous semi-rough cuts, suitable for steels and stainless steels, potentially cast irons and non-ferrous materials.
RM3		Robust design with negative T-land for medium up to rough interrupted cuts, suitable for cast irons, steels, potentially hard materials.



ISO INSERTS NEGATIVE – CHIPBREAKER NAVIGATOR



Very unstable working conditions



Unstable working conditions



Stable working conditions



Thin-walled and slim workpieces

- 1st choice (ISO-P)
- Possible use (ISO-P)
- 1st choice (ISO-M)
- Possible use (ISO-M)
- 1st choice (ISO-K)
- Possible use (ISO-K)
- 1st choice (ISO-S)
- Possible use (ISO-S)
- 1st choice (ISO-H)
- Possible use (ISO-H)



	.002 – .008 in/rev 0.05 – 0.2 mm/rev		.008 – .016 in/rev 0.2 – 0.4 mm/rev	.016 – .039 in/rev 0.4 – 1.0 mm/rev	> .039 in/rev > 1.0 mm/rev
	.002 – .079 in 0.05 – 2 mm		.078 – .157 in 2 – 4 mm	.157 – .394 in 4 – 10 mm	> .394 in > 10 mm

FF		Highly positive design for fine finish continuous cuts, suitable for steels and stainless steels, potentially cast irons.	FM		Positive design for fine moderately interrupted cuts to semi-rough continuous cuts, suitable for steels, cast irons, potentially stainless steels and super alloys.
SF		Positive design for fine finish continuous cuts, suitable for super alloys, stainless steels, steels, potentially cast irons, hard and non-ferrous materials.	SM		Versatile design for light interrupted cuts up to semi-rough continuous cuts, suitable for stainless steels, super alloys, steels and cast irons, potentially non-ferrous and hard materials.
NM		Highly positive design for semi-finish up to semi-rough continuous cuts, suitable for stainless steels, soft steels and super alloys, potentially non-ferrous materials.	RM		Versatile design stable T-land for medium interrupted cuts up to rough continuous cuts, suitable for steels, stainless steels and cast irons, potentially super alloys.

FF2

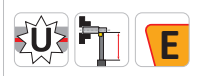
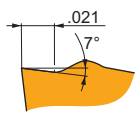

FF2 chip breaker is sharp and the first choice for fine-finishing of Steels. It features slightly positive rake angle without T-land. It's also suitable for Cast irons.



VCGT

	IC	D1	L	S
	(inch)	(inch)	(inch)	(inch)
1.21.5	.156	.087	.272	.094

VCGX

	IC	D1	L	S
	(inch)	(inch)	(inch)	(inch)
2.52	.313	.134	.543	.125

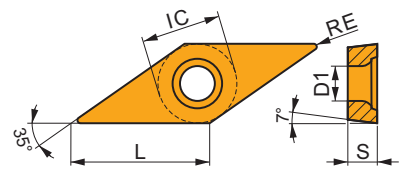
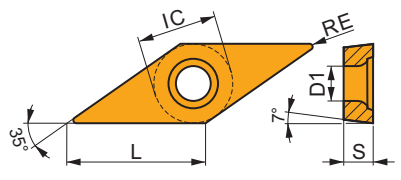

Suitability and starting values for cutting speed (vc), feed (f) and depth of cut (ap). Refer to our cutting conditions app for further options.

Product	RE (inch)	P			M			K			N			S			H			MID
		vc (ft/min)	f (in/rev)	ap (inch)	vc (ft/min)	f (in/rev)	ap (inch)	vc (ft/min)	f (in/rev)	ap (inch)	vc (ft/min)	f (in/rev)	ap (inch)	vc (ft/min)	f (in/rev)	ap (inch)	vc (ft/min)	f (in/rev)	ap (inch)	

			FF2 chip breaker is sharp and the first choice for fine-finishing of Steels. It features slightly positive rake angle without T-land. It's also suitable for Cast irons.																	
VCGT 1.21.50.5-FF2	T8415	.008	607	.002	.031	-	-	-	541	.002	.031	-	-	-	-	-	-	-	-	8553267
VCGT 1.21.51-FF2	T8415	.016	509	.0047	.031	-	-	-	459	.0047	.031	-	-	-	-	-	-	-	-	8553269

			FF2 chip breaker is sharp and the first choice for fine-finishing of Steels. It features slightly positive rake angle without T-land. It's also suitable for Cast irons.																	
VCGX 2.520.2FR-FF2	T8415	.004	591	.002	.039	-	-	-	525	.002	.039	-	-	-	-	-	-	-	-	8553287
VCGX 2.520FR-FF2	T8415	.000	591	.002	.039	-	-	-	525	.002	.039	-	-	-	-	-	-	-	-	8553285

			FF2 chip breaker is sharp and the first choice for fine-finishing of Steels. It features slightly positive rake angle without T-land. It's also suitable for Cast irons.																	
VCGX 2.520.2FL-FF2	T8415	.004	591	.002	.039	-	-	-	525	.002	.039	-	-	-	-	-	-	-	-	8553286
VCGX 2.520FL-FF2	T8415	.000	591	.002	.039	-	-	-	525	.002	.039	-	-	-	-	-	-	-	-	8553284

SF3

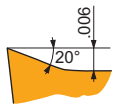

SF3 chip breaker is sharp and the first choice for fine-finishing of Stainless steels and Super-alloys. It features highly positive rake angle without T-land. It's also suitable for Non-ferrous alloys, and conditionally for Steels, Cast irons and Hard materials.

CCGT

	IC	D1	L	S
	(inch)	(inch)	(inch)	(inch)
2.52-SF3	.313	.134	.319	.135
21.5-SF3	.250	.110	.252	.102
32.5-SF3	.375	.173	.382	.166
43-SF3	.500	.217	.508	.197

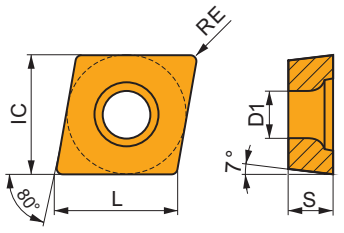

DCGT

	IC	D1	L	S
	(inch)	(inch)	(inch)	(inch)
21.5-SF3	.250	.110	.307	.102
32.5-SF3	.375	.173	.457	.166

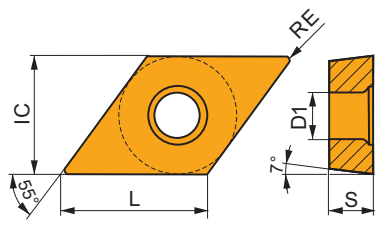

ECGT

	IC	D1	L	S
	(inch)	(inch)	(inch)	(inch)
2.52-SF3	.313	.134	.323	.135
21.5-SF3	.250	.110	.256	.102

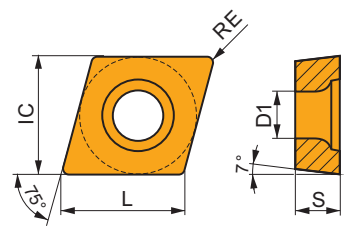

SCGT

	IC	D1	L	S
	(inch)	(inch)	(inch)	(inch)
32.5-SF3	.375	.173	.375	.166

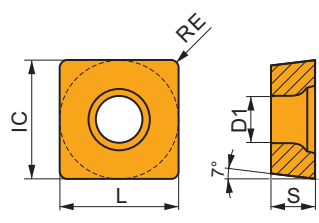

TCGT

	IC	D1	L	S
	(inch)	(inch)	(inch)	(inch)
21.5-SF3	.250	.110	.433	.102
32.5-SF3	.375	.173	.650	.166

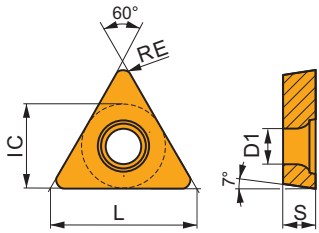

VCGT

	IC	D1	L	S
	(inch)	(inch)	(inch)	(inch)
1.21.5	.156	.087	.272	.094
2.52-SF3	.313	.134	.543	.135
21.5-SF3	.250	.110	.437	.102
22	.250	.110	.437	.135
33	.375	.173	.654	.197

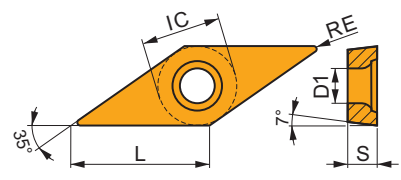

Suitability and starting values for cutting speed (vc), feed (f) and depth of cut (ap). Refer to our cutting conditions app for further options.

Product	RE (inch)	P			M			K			N			S			H			MID
		vc (ft/min)	f (in/rev)	ap (inch)	vc (ft/min)	f (in/rev)	ap (inch)	vc (ft/min)	f (in/rev)	ap (inch)	vc (ft/min)	f (in/rev)	ap (inch)	vc (ft/min)	f (in/rev)	ap (inch)	vc (ft/min)	f (in/rev)	ap (inch)	

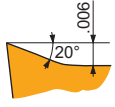
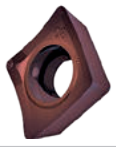

SF3 chip breaker is sharp and the first choice for fine-finishing of Stainless steels and Super-alloys. It features highly positive rake angle without T-land. It's also suitable for Non-ferrous alloys, and conditionally for Steels, Cast irons and Hard materials.

CCGT 2.520.5-SF3	T8415	.008	886	.002	.031	459	.0018	.031	804	.002	.031	2215	.0024	.031	197	.0014	.025	148	.002	.006	8553193
CCGT 2.521-SF3	T8415	.016	738	.0039	.039	377	.0035	.039	673	.0039	.039	1870	.0047	.039	164	.0028	.031	115	.0039	.013	8553194
CCGT 21.50.5-SF3	T8415	.008	886	.002	.031	459	.0018	.031	804	.002	.031	2215	.0024	.031	197	.0014	.025	148	.002	.006	8553190
CCGT 21.51-SF3	T8415	.016	755	.0039	.031	394	.0035	.031	689	.0039	.031	1919	.0047	.031	164	.0028	.025	131	.0028	.013	8553192
CCGT 32.50.5-SF3	T8415	.008	886	.002	.031	459	.0018	.031	804	.002	.031	2215	.0024	.031	197	.0014	.025	148	.002	.006	8553195
CCGT 32.51-SF3	T8415	.016	738	.0039	.039	377	.0035	.039	673	.0039	.039	1870	.0047	.039	164	.0028	.031	115	.002	.013	8553197
CCGT 32.52-SF3	T8415	.031	902	.0039	.039	459	.0035	.039	820	.0039	.039	2264	.0047	.039	197	.0031	.031	148	.0031	.026	8553198
CCGT 431-SF3	T8415	.016	738	.0039	.039	377	.0035	.039	673	.0039	.039	1870	.0047	.039	164	.0028	.031	115	.0028	.013	8553199
CCGT 432-SF3	T8415	.031	837	.0047	.039	443	.0047	.039	755	.0047	.039	2116	.0057	.039	180	.0043	.031	148	.004	.026	8553200

■ Primary use ▣ Possible use

Suitability and starting values for cutting speed (vc), feed (f) and depth of cut (ap). Refer to our cutting conditions app for further options.

Product	RE <small>(inch)</small>	P			M			K			N			S			H			MID
		vc	f	ap	vc	f	ap	vc	f	ap	vc	f	ap	vc	f	ap	vc	f	ap	
		<small>(ft/min)</small>	<small>(in/rev)</small>	<small>(inch)</small>	<small>(ft/min)</small>	<small>(in/rev)</small>	<small>(inch)</small>	<small>(ft/min)</small>	<small>(in/rev)</small>	<small>(inch)</small>	<small>(ft/min)</small>	<small>(in/rev)</small>	<small>(inch)</small>	<small>(ft/min)</small>	<small>(in/rev)</small>	<small>(inch)</small>	<small>(ft/min)</small>	<small>(in/rev)</small>	<small>(inch)</small>	

SF3 chip breaker is sharp and the first choice for fine-finishing of Stainless steels and Super-alloys. It features highly positive rake angle without T-land. It's also suitable for Non-ferrous alloys, and conditionally for Steels, Cast irons and Hard materials.

DCGT 21.50.5-SF3	T8415	.008	705	.002	.031	361	.0018	.031	640	.002	.031	1772	.0024	.031	148	.0016	.025	115	.002	.006	8553220
DCGT 21.51-SF3	T8415	.016	607	.0039	.031	312	.0035	.031	541	.0039	.031	1526	.0047	.031	131	.0028	.025	98	.0028	.013	8553221
DCGT 32.50.5-SF3	T8415	.008	705	.002	.031	361	.0018	.031	640	.002	.031	1772	.0024	.031	148	.0016	.025	115	.002	.006	8553222
DCGT 32.51-SF3	T8415	.016	607	.0039	.031	312	.0035	.031	541	.0039	.031	1526	.0047	.031	131	.0028	.025	98	.0028	.013	8553223
DCGT 32.52-SF3	T8415	.031	722	.0039	.031	377	.0035	.031	656	.0039	.031	1821	.0047	.031	164	.0031	.025	115	.0031	.026	8553224

SF3 chip breaker is sharp and the first choice for fine-finishing of Stainless steels and Super-alloys. It features highly positive rake angle without T-land. It's also suitable for Non-ferrous alloys, and conditionally for Steels, Cast irons and Hard materials.

ECGT 2.521-SF3	T8415	.016	656	.0039	.039	344	.0035	.039	607	.0039	.039	1673	.0047	.039	148	.0028	.031	115	.002	.013	8553238
ECGT 21.50.5-SF3	T8415	.008	787	.002	.031	410	.0018	.031	705	.002	.031	1969	.0024	.031	180	.0014	.025	131	.002	.006	8553237

SF3 chip breaker is sharp and the first choice for fine-finishing of Stainless steels and Super-alloys. It features highly positive rake angle without T-land. It's also suitable for Non-ferrous alloys, and conditionally for Steels, Cast irons and Hard materials.

SCGT 32.51-SF3	T8415	.016	787	.0039	.039	410	.0035	.039	705	.0039	.039	1969	.0047	.039	180	.0028	.031	131	.002	.013	8553243
SCGT 32.52-SF3	T8415	.031	886	.0047	.039	459	.0047	.039	804	.0047	.039	2215	.0057	.039	197	.0043	.031	148	.004	.026	8553244

SF3 chip breaker is sharp and the first choice for fine-finishing of Stainless steels and Super-alloys. It features highly positive rake angle without T-land. It's also suitable for Non-ferrous alloys, and conditionally for Steels, Cast irons and Hard materials.

TCGT 21.50.5-SF3	T8415	.008	738	.002	.031	377	.0018	.031	673	.002	.031	1870	.0024	.031	164	.0016	.025	115	.002	.006	8553250
TCGT 21.51-SF3	T8415	.016	640	.0039	.031	328	.0035	.031	591	.0039	.031	1624	.0047	.031	148	.0028	.025	98	.0028	.013	8553252
TCGT 32.51-SF3	T8415	.016	640	.0039	.039	328	.0035	.039	591	.0039	.039	1624	.0047	.039	148	.0028	.031	98	.0028	.013	8553253
TCGT 32.52-SF3	T8415	.031	738	.0039	.047	377	.0035	.047	673	.0039	.047	1870	.0047	.047	164	.0031	.038	115	.0031	.026	8553254
TCGT 32.53-SF3	T8415	.047	623	.0079	.047	328	.0071	.047	558	.0079	.047	1575	.0094	.047	131	.0055	.038	98	.0039	.035	8553255

SF3 chip breaker is sharp and the first choice for fine-finishing of Stainless steels and Super-alloys. It features highly positive rake angle without T-land. It's also suitable for Non-ferrous alloys, and conditionally for Steels, Cast irons and Hard materials.

VCGT 1.21.50.5-SF3	T8415	.008	607	.002	.031	312	.0018	.031	541	.002	.031	1526	.0024	.031	131	.0014	.025	98	.002	.006	8553268
VCGT 1.21.51-SF3	T8415	.016	525	.0039	.031	279	.0035	.031	476	.0039	.031	1329	.0047	.031	115	.0028	.025	82	.0028	.013	8553270
VCGT 2.520.5-SF3	T8415	.008	607	.002	.031	312	.0018	.031	541	.002	.031	1526	.0024	.031	131	.0014	.025	98	.002	.006	8553275
VCGT 2.521-SF3	T8415	.016	525	.0039	.039	279	.0035	.039	476	.0039	.039	1329	.0047	.039	115	.0028	.031	82	.0028	.013	8553277
VCGT 2.522-SF3	T8415	.031	623	.0039	.039	328	.0035	.039	558	.0039	.039	1575	.0047	.039	131	.0031	.031	98	.0031	.026	8553279
VCGT 21.50.5-SF3	T8415	.008	607	.002	.031	312	.0018	.031	541	.002	.031	1526	.0024	.031	131	.0014	.025	98	.002	.006	8553271
VCGT 21.51-SF3	T8415	.016	525	.0039	.031	279	.0035	.031	476	.0039	.031	1329	.0047	.031	115	.0028	.025	82	.0028	.013	8553272
VCGT 221-SF3	T8415	.016	525	.0039	.031	279	.0035	.031	476	.0039	.031	1329	.0047	.031	115	.0028	.025	82	.0028	.013	8553273
VCGT 330.5-SF3	T8415	.008	607	.002	.031	312	.0018	.031	541	.002	.031	1526	.0024	.031	131	.0014	.025	98	.002	.006	8553280
VCGT 331-SF3	T8415	.016	525	.0039	.039	279	.0035	.039	476	.0039	.039	1329	.0047	.039	115	.0028	.031	82	.0028	.013	8553281
VCGT 332-SF3	T8415	.031	607	.0039	.047	312	.0035	.047	541	.0039	.047	1526	.0047	.047	131	.0031	.038	98	.0031	.026	8553282
VCGT 333-SF3	T8415	.047	525	.0079	.047	279	.0071	.047	476	.0079	.047	1329	.0094	.047	115	.0055	.038	82	.0039	.035	8553283

■ Primary use ▣ Possible use

FM

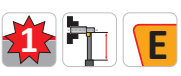
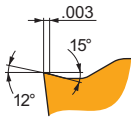

FM chip breaker is versatile and the first choice for finishing of Steels. It features positive rake angle and positive, narrow T-land. It's also suitable for Stainless steels, and conditionally for Cast irons and Non-ferrous alloys.



CCMT

	IC	D1	L	S
	(inch)	(inch)	(inch)	(inch)
21.5	.250	.110	.252	.094
32.5	.375	.173	.382	.156
43	.500	.217	.508	.187

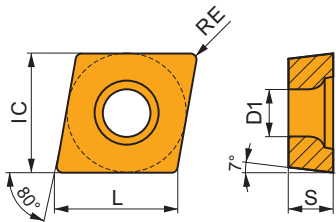

DCMT

	IC	D1	L	S
	(inch)	(inch)	(inch)	(inch)
21.5	.250	.110	.307	.094
32.5	.375	.173	.457	.156

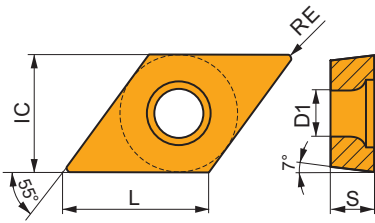

SCMT

	IC	D1	L	S
	(inch)	(inch)	(inch)	(inch)
32.5	.375	.173	.375	.156
43	.500	.217	.500	.187

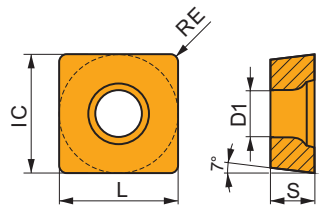

TCMT

	IC	D1	L	S
	(inch)	(inch)	(inch)	(inch)
21.5	.250	.110	.433	.094
32.5	.375	.173	.650	.156

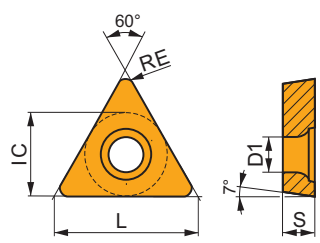

VBMT

	IC	D1	L	S
	(inch)	(inch)	(inch)	(inch)
22	.250	.110	.437	.125
33	.375	.173	.654	.187

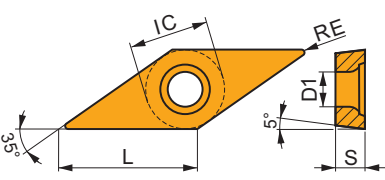

WCMT

	IC	D1	L	S
	(inch)	(inch)	(inch)	(inch)
32	.375	.173	.256	.156

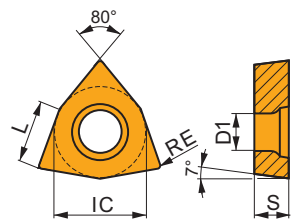

Suitability and starting values for cutting speed (vc), feed (f) and depth of cut (ap). Refer to our cutting conditions app for further options.

Product	RE (inch)	P			M			K			N			S			H			MID
		vc (ft/min)	f (in/rev)	ap (inch)	vc (ft/min)	f (in/rev)	ap (inch)	vc (ft/min)	f (in/rev)	ap (inch)	vc (ft/min)	f (in/rev)	ap (inch)	vc (ft/min)	f (in/rev)	ap (inch)	vc (ft/min)	f (in/rev)	ap (inch)	

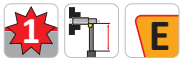
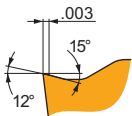
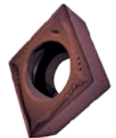

FM chip breaker is versatile and the first choice for finishing of Steels. It features positive rake angle and positive, narrow T-land. It's also suitable for Stainless steels, and conditionally for Cast irons and Non-ferrous alloys.

CCMT 21.50.5-FM	T8415	.008	787	.0039	.039	410	.0035	.039	705	.0039	.039	1969	.0047	.039	—	—	—	—	—	—	8553201
CCMT 21.51-FM	T8415	.016	738	.0059	.039	377	.0053	.039	673	.0059	.039	1870	.0071	.039	—	—	—	—	—	—	8553204
CCMT 32.50.5-FM	T8415	.008	755	.0039	.047	394	.0035	.047	689	.0039	.047	1919	.0047	.047	—	—	—	—	—	—	8553207
CCMT 32.51-FM	T8415	.016	722	.0059	.047	377	.0053	.047	656	.0059	.047	1821	.0071	.047	—	—	—	—	—	—	8553209
CCMT 32.52-FM	T8415	.031	787	.0079	.047	410	.0071	.047	705	.0079	.047	1969	.0094	.047	—	—	—	—	—	—	8553212
CCMT 431-FM	T8415	.016	689	.0059	.067	361	.0053	.067	623	.0059	.067	1722	.0071	.067	—	—	—	—	—	—	8553215
CCMT 432-FM	T8415	.031	755	.0079	.067	394	.0071	.067	689	.0079	.067	1919	.0094	.067	—	—	—	—	—	—	8553216

■ Primary use ▣ Possible use

Suitability and starting values for cutting speed (vc), feed (f) and depth of cut (ap). Refer to our cutting conditions app for further options.

Product	RE (inch)	P			M			K			N			S			H			MID
		vc	f	ap	vc	f	ap	vc	f	ap	vc	f	ap	vc	f	ap	vc	f	ap	
		(ft/min)	(in/rev)	(inch)	(ft/min)	(in/rev)	(inch)	(ft/min)	(in/rev)	(inch)	(ft/min)	(in/rev)	(inch)	(ft/min)	(in/rev)	(inch)	(ft/min)	(in/rev)	(inch)	

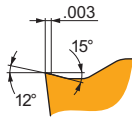
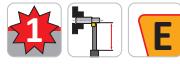
FM chip breaker is versatile and the first choice for finishing of Steels. It features positive rake angle and positive, narrow T-land. It's also suitable for Stainless steels, and conditionally for Cast irons and Non-ferrous alloys.

DCMT 21.50.5-FM	T8415	.008	623	.0039	.031	328	.0035	.031	558	.0039	.031	1575	.0047	.031						8553225
DCMT 21.51-FM	T8415	.016	623	.0047	.031	328	.0043	.031	558	.0047	.031	1575	.0057	.031						8553227
DCMT 32.50.5-FM	T8415	.008	623	.0039	.031	328	.0035	.031	558	.0039	.031	1575	.0047	.031						8553229
DCMT 32.51-FM	T8415	.016	623	.0047	.031	328	.0043	.031	558	.0047	.031	1575	.0057	.031						8553230
DCMT 32.52-FM	T8415	.031	689	.0067	.031	361	.006	.031	623	.0067	.031	1722	.008	.031						8553232

FM chip breaker is versatile and the first choice for finishing of Steels. It features positive rake angle and positive, narrow T-land. It's also suitable for Stainless steels, and conditionally for Cast irons and Non-ferrous alloys.

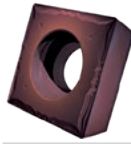
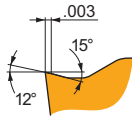
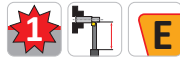
SCMT 32.51-FM	T8415	.016	755	.0059	.047	394	.0053	.047	689	.0059	.047	1919	.0071	.047						8553245
SCMT 32.52-FM	T8415	.031	820	.0079	.047	427	.0071	.047	738	.0079	.047	2067	.0094	.047						8553246
SCMT 431-FM	T8415	.016	738	.0059	.063	377	.0053	.063	673	.0059	.063	1870	.0071	.063						8553247
SCMT 432-FM	T8415	.031	804	.0079	.063	410	.0071	.063	722	.0079	.063	2018	.0094	.063						8553248

FM chip breaker is versatile and the first choice for finishing of Steels. It features positive rake angle and positive, narrow T-land. It's also suitable for Stainless steels, and conditionally for Cast irons and Non-ferrous alloys.

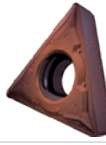
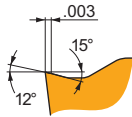
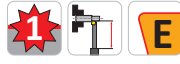
TCMT 21.50.5-FM	T8415	.008	656	.0039	.031	344	.0035	.031	607	.0039	.031	1673	.0047	.031						8553256
TCMT 21.51-FM	T8415	.016	689	.0047	.031	361	.0043	.031	623	.0047	.031	1722	.0057	.031						8553257
TCMT 32.51-FM	T8415	.016	623	.0047	.067	328	.0043	.067	558	.0047	.067	1575	.0057	.067						8553258
TCMT 32.52-FM	T8415	.031	689	.0067	.067	361	.006	.067	623	.0067	.067	1722	.008	.067						8553260

FM chip breaker is versatile and the first choice for finishing of Steels. It features positive rake angle and positive, narrow T-land. It's also suitable for Stainless steels, and conditionally for Cast irons and Non-ferrous alloys.

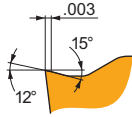
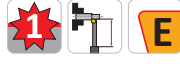
VBMT 220.5-FM	T8415	.008	591	.0039	.031	295	.0035	.031	525	.0039	.031	1476	.0047	.031						8553263
VBMT 221-FM	T8415	.016	591	.0047	.031	295	.0043	.031	525	.0047	.031	1476	.0057	.031						8553264
VBMT 331-FM	T8415	.016	558	.0047	.047	295	.0043	.047	509	.0047	.047	1427	.0057	.047						8553265
VBMT 332-FM	T8415	.031	607	.0067	.047	312	.006	.047	541	.0067	.047	1526	.008	.047						8553266

FM chip breaker is versatile and the first choice for finishing of Steels. It features positive rake angle and positive, narrow T-land. It's also suitable for Stainless steels, and conditionally for Cast irons and Non-ferrous alloys.

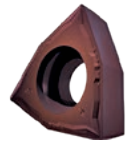
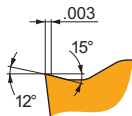
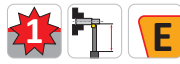
WCMT 32.51-FM	T8415	.016	722	.0059	.047	377	.0053	.047	656	.0059	.047	1821	.0071	.047						8553291
WCMT 32.52-FM	T8415	.031	787	.0079	.047	410	.0071	.047	705	.0079	.047	1969	.0094	.047						8553292

NF2

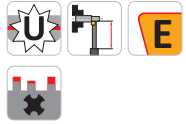
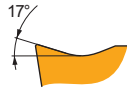

NF2 chip breaker is sharp and the first choice for finishing of Stainless steels. It features positive rake angle without T-land. It's also suitable for Super-alloys, and conditionally for Steels, Cast irons and Non-ferrous alloys.



CCMT

	IC	D1	L	S
	(inch)	(inch)	(inch)	(inch)
21.5	.250	.110	.252	.094
32.5	.375	.173	.382	.156

VCGT

	IC	D1	L	S
	(inch)	(inch)	(inch)	(inch)
2.52	.313	.134	.543	.125

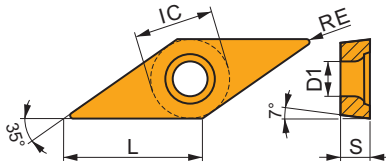
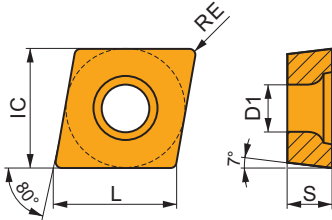

Suitability and starting values for cutting speed (vc), feed (f) and depth of cut (ap). Refer to our cutting conditions app for further options.

Product	RE (inch)	P			M			K			N			S			H			MID
		vc (ft/min)	f (in/rev)	ap (inch)	vc (ft/min)	f (in/rev)	ap (inch)	vc (ft/min)	f (in/rev)	ap (inch)	vc (ft/min)	f (in/rev)	ap (inch)	vc (ft/min)	f (in/rev)	ap (inch)	vc (ft/min)	f (in/rev)	ap (inch)	

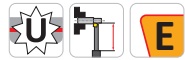
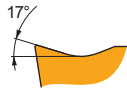
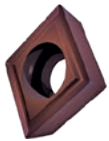

NF2 chip breaker is sharp and the first choice for finishing of Stainless steels. It features positive rake angle without T-land. It's also suitable for Super-alloys, and conditionally for Steels, Cast irons and Non-ferrous alloys.

CCMT 21.50.5-NF2	T8415	.008	722	.0039	.031	377	.0035	.031	656	.0039	.031	1821	.0047	.031	164	.0031	.025	-	-	-	8553202
CCMT 21.51-NF2	T8415	.016	722	.0047	.031	377	.0043	.031	656	.0047	.031	1821	.0057	.031	164	.0043	.025	-	-	-	8553205
CCMT 32.51-NF2	T8415	.016	705	.0047	.047	361	.0043	.047	640	.0047	.047	1772	.0057	.047	148	.0043	.038	-	-	-	8553210
CCMT 32.52-NF2	T8415	.031	804	.0055	.047	410	.005	.047	722	.0055	.047	2018	.0066	.047	180	.005	.038	-	-	-	8553213

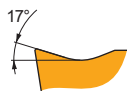

NF2 chip breaker is sharp and the first choice for finishing of Stainless steels. It features positive rake angle without T-land. It's also suitable for Super-alloys, and conditionally for Steels, Cast irons and Non-ferrous alloys.

VCGT 2.520.5-NF2	T8415	.008	525	.0028	.039	279	.0025	.039	476	.0028	.039	1329	.0033	.039	115	.0025	.031	-	-	-	8553274
VCGT 2.521-NF2	T8415	.016	492	.0047	.039	246	.0043	.039	443	.0047	.039	1230	.0057	.039	98	.0043	.031	-	-	-	8553276
VCGT 2.522-NF2	T8415	.031	525	.0067	.039	279	.006	.039	476	.0067	.039	1329	.008	.039	115	.0047	.031	-	-	-	8553278

UR

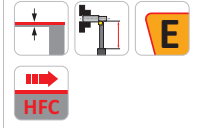
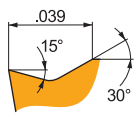

UR chip breaker is versatile and the first choice for finishing of Cast irons. It features positive rake angle without T-land. It's also suitable for Steels, and conditionally for Stainless steels.



CCMT

	IC	D1	L	S
	(inch)	(inch)	(inch)	(inch)
21.5	.250	.110	.252	.094
32.5	.375	.173	.382	.156

DCMT

	IC	D1	L	S
	(inch)	(inch)	(inch)	(inch)
21.5	.250	.110	.307	.094
32.5	.375	.173	.457	.156

RCMT

	INSD	D1	S
	(inch)	(inch)	(inch)
0602	.236	.110	.094
0803	.315	.134	.125
10T3	.394	.173	.156
1204	.472	.173	.187

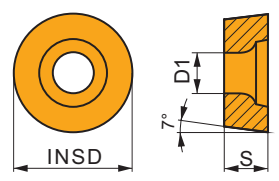
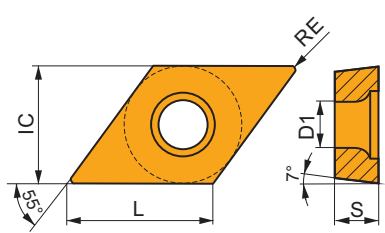
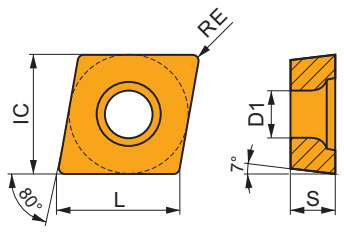

Suitability and starting values for cutting speed (vc), feed (f) and depth of cut (ap). Refer to our cutting conditions app for further options.

Product	RE (inch)	P			M			K			N			S			H			MID
		vc	f	ap	vc	f	ap	vc	f	ap	vc	f	ap	vc	f	ap				
		(ft/min)	(in/rev)	(inch)	(ft/min)	(in/rev)	(inch)	(ft/min)	(in/rev)	(inch)	(ft/min)	(in/rev)	(inch)	(ft/min)	(in/rev)	(inch)	(ft/min)	(in/rev)	(inch)	

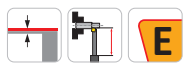
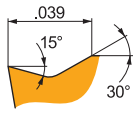
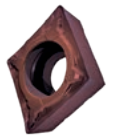

UR chip breaker is versatile and the first choice for finishing of Cast irons. It features positive rake angle without T-land. It's also suitable for Steels, and conditionally for Stainless steels.

CCMT 21.50.5-UR	T8415	.008	689	.0039	.031	361	.0035	.031	623	.0039	.031	-	-	-	-	-	-	-	-	8553203
CCMT 21.51-UR	T8415	.016	623	.0059	.039	328	.0053	.039	558	.0059	.039	-	-	-	-	-	-	-	-	8553206
CCMT 32.50.5-UR	T8415	.008	656	.0039	.039	344	.0035	.039	607	.0039	.039	-	-	-	-	-	-	-	-	8553208
CCMT 32.51-UR	T8415	.016	623	.0059	.047	328	.0053	.047	558	.0059	.047	-	-	-	-	-	-	-	-	8553211
CCMT 32.52-UR	T8415	.031	656	.0079	.047	344	.0071	.047	607	.0079	.047	-	-	-	-	-	-	-	-	8553214

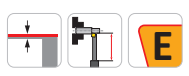
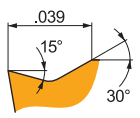

UR chip breaker is versatile and the first choice for finishing of Cast irons. It features positive rake angle without T-land. It's also suitable for Steels, and conditionally for Stainless steels.

DCMT 21.50.5-UR	T8415	.008	541	.0039	.031	279	.0035	.031	492	.0039	.031	-	-	-	-	-	-	-	-	8553226
DCMT 21.51-UR	T8415	.016	541	.0047	.031	279	.0043	.031	492	.0047	.031	-	-	-	-	-	-	-	-	8553228
DCMT 32.51-UR	T8415	.016	541	.0047	.031	279	.0043	.031	492	.0047	.031	-	-	-	-	-	-	-	-	8553231
DCMT 32.52-UR	T8415	.031	591	.0067	.031	295	.006	.031	525	.0067	.031	-	-	-	-	-	-	-	-	8553233

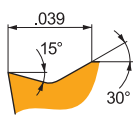
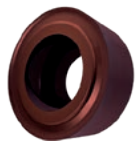

UR chip breaker is versatile and the first choice for finishing of Cast irons. It features positive rake angle without T-land. It's also suitable for Steels, and conditionally for Stainless steels.

RCMT 0602MOE-UR	T8415	-	722	.0157	.047	377	.0142	.047	656	.0157	.047	-	-	-	-	-	-	-	-	8553239
RCMT 0803MOE-UR	T8415	-	656	.0177	.063	344	.0159	.063	607	.0177	.063	-	-	-	-	-	-	-	-	8553240
RCMT 10T3MOE-UR	T8415	-	656	.0197	.055	344	.0177	.055	607	.0197	.055	-	-	-	-	-	-	-	-	8553241
RCMT 1204MOE-UR	T8415	-	623	.0217	.071	328	.0195	.071	558	.0217	.071	-	-	-	-	-	-	-	-	8553242

■ Primary use ▣ Possible use

SI



SI chip breaker is sharp and the first choice for medium machining of Stainless steels. It features highly positive rake angle without T-land. It's also suitable for Steels and Super-alloys, and conditionally for Cast irons.

CCGT

	IC	D1	L	S	
	(inch)	(inch)	(inch)	(inch)	
	21.5	.250	.110	.252	.094
	32.5	.375	.173	.382	.156

TCGT

	IC	D1	L	S	
	(inch)	(inch)	(inch)	(inch)	
	21.5	.250	.110	.433	.094

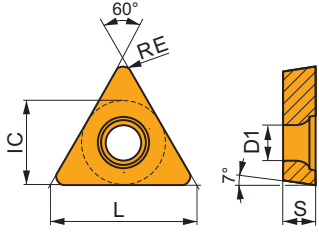
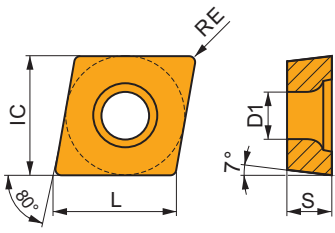

Suitability and starting values for cutting speed (vc), feed (f) and depth of cut (ap). Refer to our cutting conditions app for further options.

Product	RE (inch)	P			M			K			N			S			H			MID
		vc (ft/min)	f (in/rev)	ap (inch)	vc (ft/min)	f (in/rev)	ap (inch)	vc (ft/min)	f (in/rev)	ap (inch)	vc (ft/min)	f (in/rev)	ap (inch)	vc (ft/min)	f (in/rev)	ap (inch)				

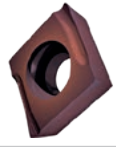

SI chip breaker is sharp and the first choice for medium machining of Stainless steels. It features highly positive rake angle without T-land. It's also suitable for Steels and Super-alloys, and conditionally for Cast irons.

CCGT 21.5L-SI	T8415	.016	■ 902	.0047	.031	■ 459	.0043	.031	■ 820	.0047	.031	■ —	■ —	■ —	■ 197	.0038	.025	■ —	■ —	■ —	8553191
CCGT 32.5L-SI	T8415	.016	■ 820	.0067	.031	■ 427	.006	.031	■ 738	.0067	.031	■ —	■ —	■ —	■ 180	.006	.025	■ —	■ —	■ —	8553196



SI chip breaker is sharp and the first choice for medium machining of Stainless steels. It features highly positive rake angle without T-land. It's also suitable for Steels and Super-alloys, and conditionally for Cast irons.

TCGT 21.50.5L-SI	T8415	.008	■ 755	.0039	.031	■ 394	.0035	.031	■ 689	.0039	.031	■ —	■ —	■ —	■ 164	.0031	.025	■ —	■ —	■ —	8553249
TCGT 21.5L-SI	T8415	.016	■ 755	.0047	.031	■ 394	.0043	.031	■ 689	.0047	.031	■ —	■ —	■ —	■ 164	.0038	.025	■ —	■ —	■ —	8553251



CMW

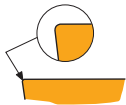

..W flat insert is designed for medium machining of Cast irons. It features neutral rake angle without T-land. It's also conditionally suitable for Hard materials.



CCMW

	IC	D1	L	S
	(inch)	(inch)	(inch)	(inch)
21.5	.250	.110	.252	.094
32.5	.375	.173	.382	.156

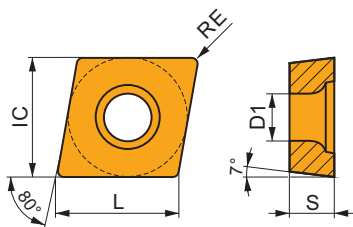

DCMW

	IC	D1	L	S
	(inch)	(inch)	(inch)	(inch)
21.5	.250	.110	.307	.094
32.5	.375	.173	.457	.156

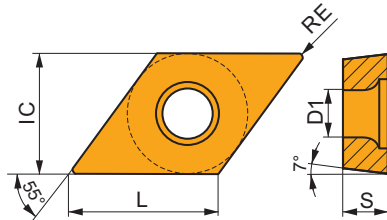

TCMW

	IC	D1	L	S
	(inch)	(inch)	(inch)	(inch)
32.5	.375	.173	.650	.156

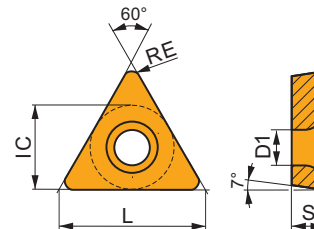

VCMW

	IC	D1	L	S
	(inch)	(inch)	(inch)	(inch)
22	.250	.110	.437	.125
33	.375	.173	.654	.187

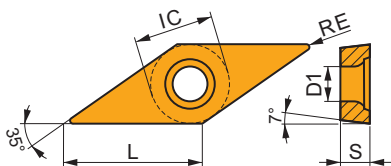

Suitability and starting values for cutting speed (vc), feed (f) and depth of cut (ap). Refer to our cutting conditions app for further options.

Product	RE (inch)	P			M			K			N			S			H			MID
		vc (ft/min)	f (in/rev)	ap (inch)	vc (ft/min)	f (in/rev)	ap (inch)	vc (ft/min)	f (in/rev)	ap (inch)	vc (ft/min)	f (in/rev)	ap (inch)	vc (ft/min)	f (in/rev)	ap (inch)				

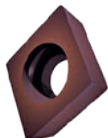

..W flat insert is designed for medium machining of Cast irons. It features neutral rake angle without T-land. It's also conditionally suitable for Hard materials.

CCMW 21.51	T8415	.016	■	-	-	-	■	476	.0039	.079	■	-	-	-	■	82	.0039	.013	8553217
CCMW 32.51	T8415	.016	■	-	-	-	■	443	.0039	.118	■	-	-	-	■	82	.0039	.013	8553218
CCMW 32.52	T8415	.031	■	-	-	-	■	443	.0079	.118	■	-	-	-	■	82	.0043	.026	8553219

■ Primary use ▣ Possible use



Suitability and starting values for cutting speed (vc), feed (f) and depth of cut (ap). Refer to our cutting conditions app for further options.

Product	RE (inch)	P			M			K			N			S			H			MID
		vc (ft/min)	f (in/rev)	ap (inch)	vc (ft/min)	f (in/rev)	ap (inch)	vc (ft/min)	f (in/rev)	ap (inch)	vc (ft/min)	f (in/rev)	ap (inch)	vc (ft/min)	f (in/rev)	ap (inch)	vc (ft/min)	f (in/rev)	ap (inch)	

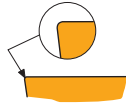
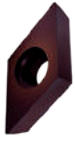

..W flat insert is designed for medium machining of Cast irons. It features neutral rake angle without T-land. It's also conditionally suitable for Hard materials.

DCMW 21.51	T8415	.016	-	-	-	-	-	-	410	.0039	.031	-	-	-	-	-	-	66	.0039	.013	8553234
DCMW 32.51	T8415	.016	-	-	-	-	-	-	394	.0039	.047	-	-	-	-	-	-	66	.0039	.013	8553235
DCMW 32.52	T8415	.031	-	-	-	-	-	-	410	.0071	.047	-	-	-	-	-	-	66	.0043	.026	8553236

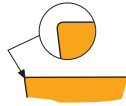
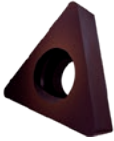

..W flat insert is designed for medium machining of Cast irons. It features neutral rake angle without T-land. It's also conditionally suitable for Hard materials.

TCMW 32.52	T8415	.031	-	-	-	-	-	-	410	.0071	.059	-	-	-	-	-	-	66	.0043	.026	8553262
------------	-------	------	---	---	---	---	---	---	-----	-------	------	---	---	---	---	---	---	----	-------	------	---------



..W flat insert is designed for medium machining of Cast irons. It features neutral rake angle without T-land. It's also conditionally suitable for Hard materials.

VCMW 221	T8415	.016	-	-	-	-	-	-	344	.0039	.047	-	-	-	-	-	-	66	.0039	.013	8553288
VCMW 331	T8415	.016	-	-	-	-	-	-	328	.0039	.059	-	-	-	-	-	-	49	.0039	.013	8553289
VCMW 332	T8415	.031	-	-	-	-	-	-	328	.0071	.059	-	-	-	-	-	-	49	.0043	.026	8553290



RM3

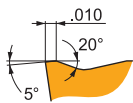

RM3 chip breaker is robust and designed for roughing of Steels and Cast irons. It features positive rake angle and negative, wide T-land. It's also conditionally suitable for Stainless steels and Hard materials.



TCMT

	IC	D1	L	S
	(inch)	(inch)	(inch)	(inch)
32.5	.375	.173	.650	.156

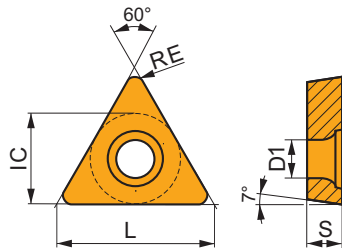

Suitability and starting values for cutting speed (vc), feed (f) and depth of cut (ap). Refer to our cutting conditions app for further options.

Product	RE (inch)	P			M			K			N			S			H			MID
		vc (ft/min)	f (in/rev)	ap (inch)	vc (ft/min)	f (in/rev)	ap (inch)	vc (ft/min)	f (in/rev)	ap (inch)	vc (ft/min)	f (in/rev)	ap (inch)	vc (ft/min)	f (in/rev)	ap (inch)				

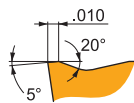
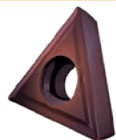

RM3 chip breaker is robust and designed for roughing of Steels and Cast irons. It features positive rake angle and negative, wide T-land. It's also conditionally suitable for Stainless steels and Hard materials.

TCMT 32.51-RM3	T8415	.016	■ 492	.0079	.079	▣ 246	.0079	.079	■ 443	.0079	.079	—	—	—	—	—	—	▣ 82	.0055	.013	8553259
TCMT 32.52-RM3	T8415	.031	■ 525	.0106	.079	▣ 279	.0106	.079	■ 476	.0106	.079	—	—	—	—	—	—	▣ 82	.0053	.026	8553261

■ Primary use ▣ Possible use



FF

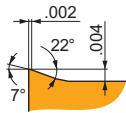

FF chip breaker is sharp and designed for fine-finishing of Steels, Stainless steels. It features positive rake angle and positive, thin T-land. It's also conditionally suitable for Cast irons.



CNMG

	IC	D1	L	S
	(inch)	(inch)	(inch)	(inch)
43	.500	.203	.508	.187

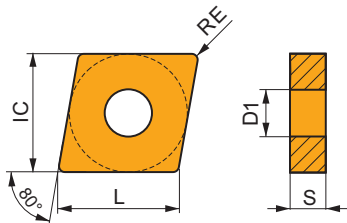

DNMG

	IC	D1	L	S
	(inch)	(inch)	(inch)	(inch)
33	.375	.150	.457	.187
44	.500	.203	.610	.250

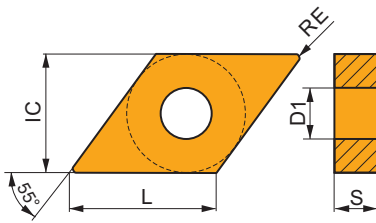

TNMG

	IC	D1	L	S
	(inch)	(inch)	(inch)	(inch)
33	.375	.150	.650	.187

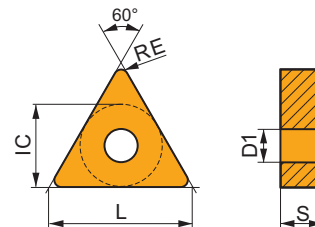

VNMG

	IC	D1	L	S
	(inch)	(inch)	(inch)	(inch)
33	.375	.150	.654	.187

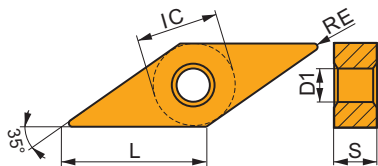

WNMG

	IC	D1	L	S
	(inch)	(inch)	(inch)	(inch)
33	.375	.150	.256	.187
43	.500	.203	.343	.187

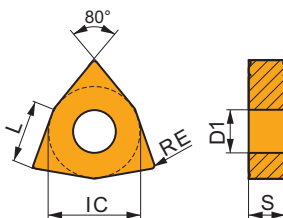



Suitability and starting values for cutting speed (vc), feed (f) and depth of cut (ap). Refer to our cutting conditions app for further options.

Product	RE (inch)	P			M			K			N			S			H			MID
		vc (ft/min)	f (in/rev)	ap (inch)	vc (ft/min)	f (in/rev)	ap (inch)	vc (ft/min)	f (in/rev)	ap (inch)	vc (ft/min)	f (in/rev)	ap (inch)	vc (ft/min)	f (in/rev)	ap (inch)	vc (ft/min)	f (in/rev)	ap (inch)	

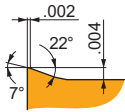
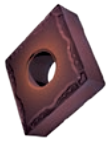

FF chip breaker is sharp and designed for fine-finishing of Steels, Stainless steels. It features positive rake angle and positive, thin T-land. It's also conditionally suitable for Cast irons.

CNMG 431-FF	T8415	.016	853	.0047	.039	443	.0043	.039	787	.0047	.039	-	-	-	-	-	-	-	8552988
CNMG 432-FF	T8415	.031	984	.0059	.039	509	.0053	.039	886	.0059	.039	-	-	-	-	-	-	-	8553062

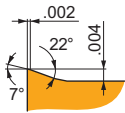

FF chip breaker is sharp and designed for fine-finishing of Steels, Stainless steels. It features positive rake angle and positive, thin T-land. It's also conditionally suitable for Cast irons.

DNMG 330.5-FF	T8415	.016	705	.0039	.031	361	.0035	.031	640	.0039	.031	-	-	-	-	-	-	-	8553078
DNMG 331-FF	T8415	.016	705	.0047	.031	361	.0043	.031	640	.0047	.031	-	-	-	-	-	-	-	8553079
DNMG 332-FF	T8415	.016	787	.0059	.031	410	.0053	.031	705	.0059	.031	-	-	-	-	-	-	-	8553083
DNMG 441-FF	T8415	.031	689	.0047	.039	361	.0043	.039	623	.0047	.039	-	-	-	-	-	-	-	8553092
DNMG 442-FF	T8415	.031	787	.0059	.039	410	.0053	.039	705	.0059	.039	-	-	-	-	-	-	-	8553097

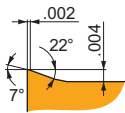
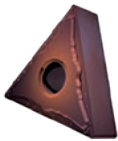

FF chip breaker is sharp and designed for fine-finishing of Steels, Stainless steels. It features positive rake angle and positive, thin T-land. It's also conditionally suitable for Cast irons.

TNMG 331-FF	T8415	.016	738	.0047	.039	377	.0043	.039	673	.0047	.039	-	-	-	-	-	-	-	8553119
TNMG 332-FF	T8415	.031	820	.0059	.039	427	.0053	.039	738	.0059	.039	-	-	-	-	-	-	-	8553125

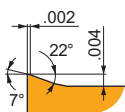

FF chip breaker is sharp and designed for fine-finishing of Steels, Stainless steels. It features positive rake angle and positive, thin T-land. It's also conditionally suitable for Cast irons.

VNMG 331-FF	T8415	.016	607	.0047	.039	312	.0043	.039	541	.0047	.039	-	-	-	-	-	-	-	8553141
-------------	-------	------	-----	-------	------	-----	-------	------	-----	-------	------	---	---	---	---	---	---	---	---------

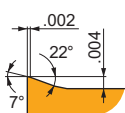
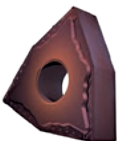

FF chip breaker is sharp and designed for fine-finishing of Steels, Stainless steels. It features positive rake angle and positive, thin T-land. It's also conditionally suitable for Cast irons.

WNMG 330.5-FF	T8415	.008	853	.0039	.039	443	.0035	.039	787	.0039	.039	-	-	-	-	-	-	-	8553150
WNMG 331-FF	T8415	.016	853	.0047	.039	443	.0043	.039	787	.0047	.039	-	-	-	-	-	-	-	8553151
WNMG 431-FF	T8415	.016	853	.0047	.039	443	.0043	.039	787	.0047	.039	-	-	-	-	-	-	-	8553156
WNMG 432-FF	T8415	.031	984	.0059	.039	509	.0053	.039	886	.0059	.039	-	-	-	-	-	-	-	8553162

■ Primary use ▣ Possible use

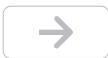

FM

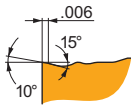

FM chip breaker is versatile and the first choice for finishing of Steels and Cast irons. It features slightly positive rake angle and positive, narrow T-land. It's also conditionally suitable for Stainless steels and Super-alloys.



CNMG

	IC	D1	L	S
	(inch)	(inch)	(inch)	(inch)
43	.500	.203	.508	.187

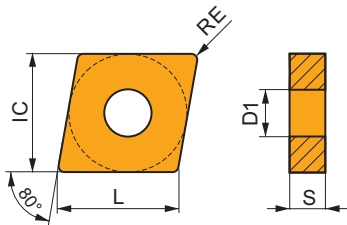

DNMG

	IC	D1	L	S
	(inch)	(inch)	(inch)	(inch)
33	.375	.150	.457	.187
44	.500	.203	.610	.250

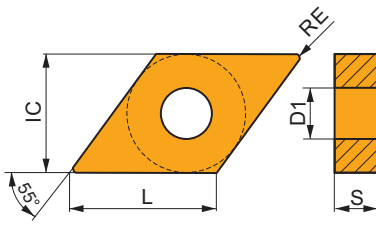

SNMG

	IC	D1	L	S
	(inch)	(inch)	(inch)	(inch)
43	.500	.203	.500	.187

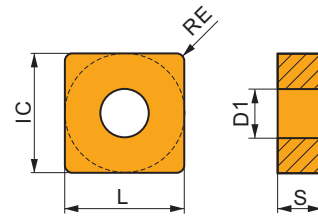

TNMG

	IC	D1	L	S
	(inch)	(inch)	(inch)	(inch)
33	.375	.150	.650	.187

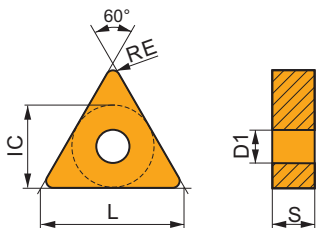

WNMG

	IC	D1	L	S
	(inch)	(inch)	(inch)	(inch)
33	.375	.150	.256	.187
43	.500	.203	.343	.187

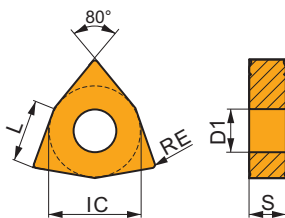

Suitability and starting values for cutting speed (vc), feed (f) and depth of cut (ap). Refer to our cutting conditions app for further options.

Product	RE (inch)	P			M			K			N			S			H			MID
		vc (ft/min)	f (in/rev)	ap (inch)	vc (ft/min)	f (in/rev)	ap (inch)	vc (ft/min)	f (in/rev)	ap (inch)	vc (ft/min)	f (in/rev)	ap (inch)	vc (ft/min)	f (in/rev)	ap (inch)	vc (ft/min)	f (in/rev)	ap (inch)	

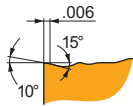
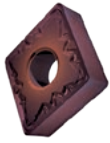

FM chip breaker is versatile and the first choice for finishing of Steels and Cast irons. It features slightly positive rake angle and positive, narrow T-land. It's also conditionally suitable for Stainless steels and Super-alloys.

CNMG 431-FM	T8415	.016	705	.0079	.083	361	.0071	.083	640	.0079	.083	-	-	-	148	.0055	.066	-	-	-	8552989
CNMG 432-FM	T8415	.031	820	.0079	.083	427	.0071	.083	738	.0079	.083	-	-	-	180	.0063	.066	-	-	-	8553063

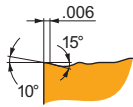

FM chip breaker is versatile and the first choice for finishing of Steels and Cast irons. It features slightly positive rake angle and positive, narrow T-land. It's also conditionally suitable for Stainless steels and Super-alloys.

DNMG 331-FM	T8415	.016	607	.0079	.031	312	.0071	.031	541	.0079	.031	-	-	-	131	.0055	.025	-	-	-	8553080
DNMG 332-FM	T8415	.031	722	.0079	.031	377	.0071	.031	656	.0079	.031	-	-	-	164	.0055	.025	-	-	-	8553084
DNMG 441-FM	T8415	.016	558	.0079	.067	295	.0071	.067	509	.0079	.067	-	-	-	115	.0055	.054	-	-	-	8553093
DNMG 442-FM	T8415	.031	689	.0079	.067	361	.0071	.067	623	.0079	.067	-	-	-	148	.0063	.054	-	-	-	8553098

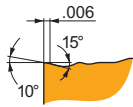
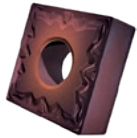

FM chip breaker is versatile and the first choice for finishing of Steels and Cast irons. It features slightly positive rake angle and positive, narrow T-land. It's also conditionally suitable for Stainless steels and Super-alloys.

SNMG 431-FM	T8415	.016	722	.0079	.083	377	.0071	.083	656	.0079	.083	-	-	-	164	.0055	.066	-	-	-	8553107
SNMG 432-FM	T8415	.031	853	.0079	.083	443	.0071	.083	787	.0079	.083	-	-	-	197	.0063	.066	-	-	-	8553108

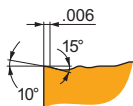
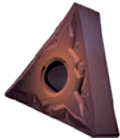

FM chip breaker is versatile and the first choice for finishing of Steels and Cast irons. It features slightly positive rake angle and positive, narrow T-land. It's also conditionally suitable for Stainless steels and Super-alloys.

TNMG 331-FM	T8415	.016	607	.0079	.067	312	.0071	.067	541	.0079	.067	-	-	-	131	.0055	.054	-	-	-	8553120
TNMG 332-FM	T8415	.031	722	.0079	.067	377	.0071	.067	656	.0079	.067	-	-	-	164	.0063	.054	-	-	-	8553126

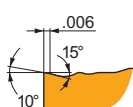
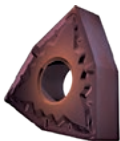

FM chip breaker is versatile and the first choice for finishing of Steels and Cast irons. It features slightly positive rake angle and positive, narrow T-land. It's also conditionally suitable for Stainless steels and Super-alloys.

WNMG 331-FM	T8415	.016	722	.0079	.055	377	.0071	.055	656	.0079	.055	-	-	-	164	.0055	.044	-	-	-	8553152
WNMG 431-FM	T8415	.016	705	.0079	.075	361	.0071	.075	640	.0079	.075	-	-	-	148	.0055	.06	-	-	-	8553157
WNMG 432-FM	T8415	.031	820	.0079	.075	427	.0071	.075	738	.0079	.075	-	-	-	180	.0063	.06	-	-	-	8553163

■ Primary use ▣ Possible use



SF

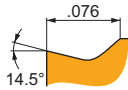

SF chip breaker is sharp and the first choice for finishing of Stainless steels and Super-alloys. It features slightly positive rake angle without T-land. It's also suitable for Steels, Cast irons and Hard materials, and conditionally for Non-ferrous alloys.

CNGG

	IC	D1	L	S
	(inch)	(inch)	(inch)	(inch)
43	.500	.203	.508	.187

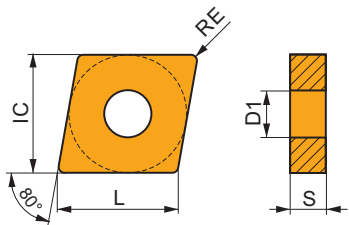

CNMG

	IC	D1	L	S
	(inch)	(inch)	(inch)	(inch)
43	.500	.203	.508	.187

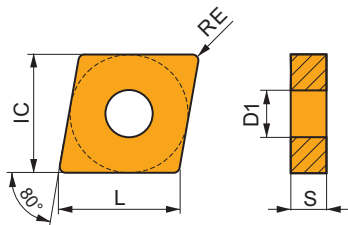

DNMG

	IC	D1	L	S
	(inch)	(inch)	(inch)	(inch)
33	.375	.150	.457	.187
43	.500	.203	.610	.187
44	.500	.203	.610	.250

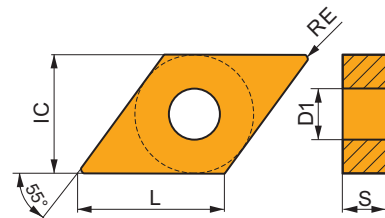

SNMG

	IC	D1	L	S
	(inch)	(inch)	(inch)	(inch)
43	.500	.203	.500	.187

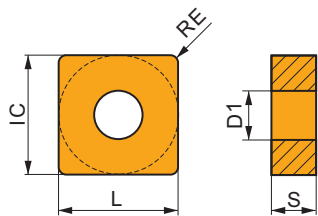

TNMG

	IC	D1	L	S
	(inch)	(inch)	(inch)	(inch)
33	.375	.150	.650	.187
43	.500	.203	.866	.187

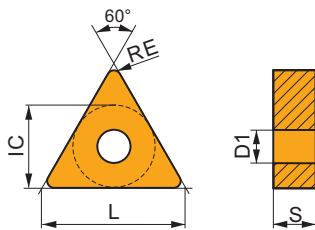

VNMG

	IC	D1	L	S
	(inch)	(inch)	(inch)	(inch)
33	.375	.150	.654	.187

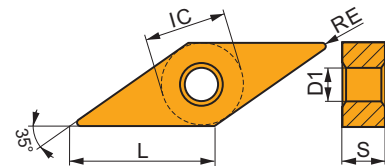

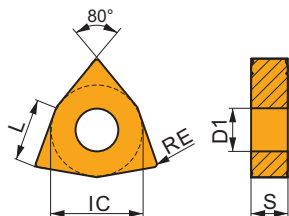

WNMG

	IC	D1	L	S
	(inch)	(inch)	(inch)	(inch)
33	.375	.150	.256	.187
43	.500	.203	.343	.187



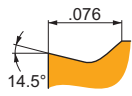

Suitability and starting values for cutting speed (vc), feed (f) and depth of cut (ap). Refer to our cutting conditions app for further options.

Product	RE <small>(inch)</small>	P			M			K			N			S			H			MID
		vc	f	ap	vc	f	ap	vc	f	ap	vc	f	ap	vc	f	ap	vc	f	ap	
		<small>(ft/min)</small>	<small>(in/rev)</small>	<small>(inch)</small>	<small>(ft/min)</small>	<small>(in/rev)</small>	<small>(inch)</small>	<small>(ft/min)</small>	<small>(in/rev)</small>	<small>(inch)</small>	<small>(ft/min)</small>	<small>(in/rev)</small>	<small>(inch)</small>	<small>(ft/min)</small>	<small>(in/rev)</small>	<small>(inch)</small>	<small>(ft/min)</small>	<small>(in/rev)</small>	<small>(inch)</small>	

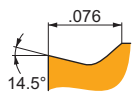

SF chip breaker is sharp and the first choice for finishing of Stainless steels and Super-alloys. It features slightly positive rake angle without T-land. It's also suitable for Steels, Cast irons and Hard materials, and conditionally for Non-ferrous alloys.

CNGG 430.5-SF	T8415	.008	820	.0039	.039	427	.0035	.039	738	.0039	.039	2067	.0047	.039	180	.0031	.031	131	.0039	.006	8552985
----------------------	--------------	------	-----	-------	------	-----	-------	------	-----	-------	------	------	-------	------	-----	-------	------	-----	-------	------	---------

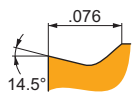

SF chip breaker is sharp and the first choice for finishing of Stainless steels and Super-alloys. It features slightly positive rake angle without T-land. It's also suitable for Steels, Cast irons and Hard materials, and conditionally for Non-ferrous alloys.

CNMG 431-SF	T8415	.016	787	.0059	.039	410	.0053	.039	705	.0059	.039	1969	.0071	.039	180	.0047	.031	131	.0041	.013	8553066
CNMG 432-SF	T8415	.031	837	.0079	.039	443	.0071	.039	755	.0079	.039	2116	.0094	.039	180	.0055	.031	148	.0039	.026	8553066
CNMG 433-SF	T8415	.047	820	.0098	.059	427	.0089	.059	738	.0098	.059	2067	.0118	.059	180	.0069	.047	131	.0049	.039	8553069

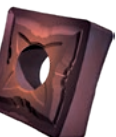
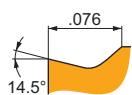

SF chip breaker is sharp and the first choice for finishing of Stainless steels and Super-alloys. It features slightly positive rake angle without T-land. It's also suitable for Steels, Cast irons and Hard materials, and conditionally for Non-ferrous alloys.

DNMG 331-SF	T8415	.016	623	.0059	.031	328	.0053	.031	558	.0059	.031	1575	.0071	.031	131	.0047	.025	98	.0041	.013	8553081
DNMG 332-SF	T8415	.031	722	.0067	.031	377	.006	.031	656	.0067	.031	1821	.008	.031	164	.0054	.025	115	.0044	.026	8553086
DNMG 431-SF	T8415	.016	591	.0059	.059	295	.0053	.059	525	.0059	.059	1476	.0071	.059	131	.0047	.047	98	.0041	.013	8553088
DNMG 432-SF	T8415	.031	689	.0067	.059	361	.006	.059	623	.0067	.059	1722	.008	.059	148	.0054	.047	115	.0044	.026	8553090
DNMG 441-SF	T8415	.016	591	.0059	.059	295	.0053	.059	525	.0059	.059	1476	.0071	.059	131	.0047	.047	98	.0041	.013	8553095
DNMG 442-SF	T8415	.031	689	.0067	.059	361	.006	.059	623	.0067	.059	1722	.008	.059	148	.0054	.047	115	.0044	.026	8553102
DNMG 443-SF	T8415	.047	640	.0098	.059	328	.0089	.059	591	.0098	.059	1624	.0118	.059	148	.0069	.047	98	.0049	.035	8553104

SF chip breaker is sharp and the first choice for finishing of Stainless steels and Super-alloys. It features slightly positive rake angle without T-land. It's also suitable for Steels, Cast irons and Hard materials, and conditionally for Non-ferrous alloys.

SNMG 432-SF	T8415	.031	902	.0079	.039	459	.0071	.039	820	.0079	.039	2264	.0094	.039	197	.0055	.031	148	.0039	.026	8553110
SNMG 433-SF	T8415	.047	853	.0098	.059	443	.0089	.059	787	.0098	.059	2165	.0118	.059	197	.0069	.047	148	.0049	.039	8553113

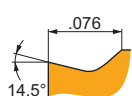
SF chip breaker is sharp and the first choice for finishing of Stainless steels and Super-alloys. It features slightly positive rake angle without T-land. It's also suitable for Steels, Cast irons and Hard materials, and conditionally for Non-ferrous alloys.

TNMG 331-SF	T8415	.016	640	.0059	.051	328	.0053	.051	591	.0059	.051	1624	.0071	.051	148	.0047	.041	98	.0041	.013	8553123
TNMG 332-SF	T8415	.031	738	.0067	.051	377	.006	.051	673	.0067	.051	1870	.008	.051	164	.0054	.041	115	.0044	.026	8553130
TNMG 333-SF	T8415	.047	689	.0098	.059	361	.0089	.059	623	.0098	.059	1722	.0118	.059	148	.0069	.047	115	.0049	.035	8553132
TNMG 431-SF	T8415	.016	607	.0067	.067	312	.006	.067	541	.0067	.067	1526	.008	.067	131	.006	.054	98	.0047	.013	8553134
TNMG 432-SF	T8415	.031	722	.0067	.067	377	.006	.067	656	.0067	.067	1821	.008	.067	164	.006	.054	115	.0047	.026	8553137
TNMG 433-SF	T8415	.047	640	.0118	.067	328	.0106	.067	591	.0118	.067	1624	.0142	.067	148	.0083	.054	98	.0059	.035	8553139



Suitability and starting values for cutting speed (vc), feed (f) and depth of cut (ap). Refer to our cutting conditions app for further options.

Product	RE (inch)	P			M			K			N			S			H			MID
		vc	f	ap	vc	f	ap	vc	f	ap	vc	f	ap	vc	f	ap	vc	f	ap	
		(ft/min)	(in/rev)	(inch)	(ft/min)	(in/rev)	(inch)	(ft/min)	(in/rev)	(inch)	(ft/min)	(in/rev)	(inch)	(ft/min)	(in/rev)	(inch)	(ft/min)	(in/rev)	(inch)	

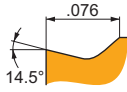

SF chip breaker is sharp and the first choice for finishing of Stainless steels and Super-alloys. It features slightly positive rake angle without T-land. It's also suitable for Steels, Cast irons and Hard materials, and conditionally for Non-ferrous alloys.

VNMG 331-SF	T8415	.016	■ 525	.0059	.047	■ 279	.0053	.047	■ 476	.0059	.047	☑ 1329	.0071	.047	■ 115	.0053	.038	■ 82	.0059	.013	8553143
VNMG 332-SF	T8415	.031	■ 607	.0067	.055	■ 312	.006	.055	■ 541	.0067	.055	☑ 1526	.008	.055	■ 131	.0054	.044	■ 98	.0044	.026	8553146

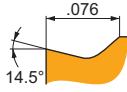
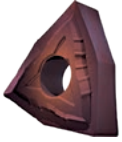

SF chip breaker is sharp and the first choice for finishing of Stainless steels and Super-alloys. It features slightly positive rake angle without T-land. It's also suitable for Steels, Cast irons and Hard materials, and conditionally for Non-ferrous alloys.

WNMG 331-SF	T8415	.016	■ 787	.0059	.039	■ 410	.0053	.039	■ 705	.0059	.039	☑ 1969	.0071	.039	■ 180	.0047	.031	■ 131	.0041	.013	8553153
WNMG 332-SF	T8415	.031	■ 837	.0079	.039	■ 443	.0071	.039	■ 755	.0079	.039	☑ 2116	.0094	.039	■ 180	.0055	.031	■ 148	.0039	.026	8553154
WNMG 431-SF	T8415	.016	■ 787	.0059	.039	■ 410	.0053	.039	■ 705	.0059	.039	☑ 1969	.0071	.039	■ 180	.0047	.031	■ 131	.0041	.013	8553160
WNMG 432-SF	T8415	.031	■ 837	.0079	.039	■ 443	.0071	.039	■ 755	.0079	.039	☑ 2116	.0094	.039	■ 180	.0055	.031	■ 148	.0039	.026	8553165

SM

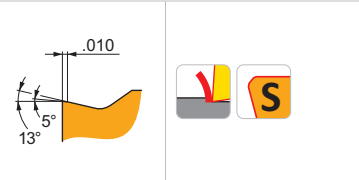

SM chip breaker is versatile and the first choice for medium machining of Steels and Super-alloys. It features slightly positive rake angle and stable, moderate T-land. It's also suitable for Stainless steels, Cast irons, and conditionally for Non-ferrous alloys and Hard materials.



CNMG

	IC	D1	L	S
	(inch)	(inch)	(inch)	(inch)
43	.500	.203	.508	.187
54	.625	.250	.634	.250
64	.750	.313	.760	.250

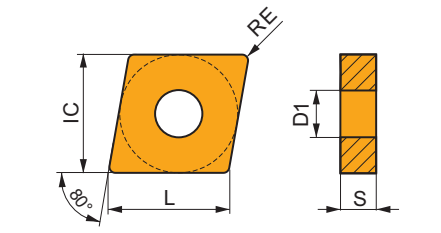

DNMG

	IC	D1	L	S
	(inch)	(inch)	(inch)	(inch)
33	.375	.150	.457	.187
43	.500	.203	.610	.187
44	.500	.203	.610	.250

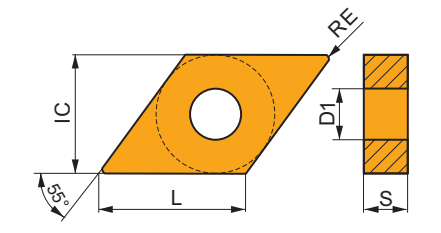

SNMG

	IC	D1	L	S
	(inch)	(inch)	(inch)	(inch)
43	.500	.203	.500	.187
64	.750	.313	.750	.250

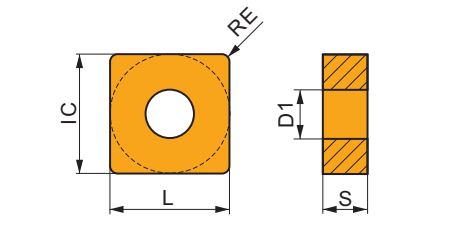

TNMG

	IC	D1	L	S
	(inch)	(inch)	(inch)	(inch)
33	.375	.150	.650	.187
43	.500	.203	.866	.187

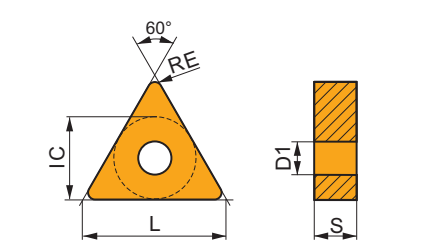

VNMG

	IC	D1	L	S
	(inch)	(inch)	(inch)	(inch)
33	.375	.150	.654	.187

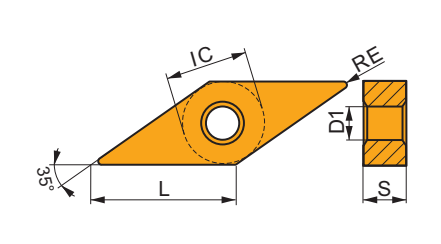

WNMG

	IC	D1	L	S
	(inch)	(inch)	(inch)	(inch)
33	.375	.150	.256	.187
43	.500	.203	.343	.187

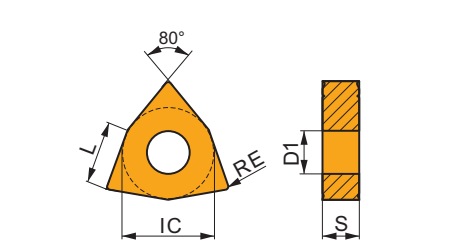

Suitability and starting values for cutting speed (vc), feed (f) and depth of cut (ap). Refer to our cutting conditions app for further options.

Product	RE (inch)	P			M			K			N			S			H			MID
		vc (ft/min)	f (in/rev)	ap (inch)	vc (ft/min)	f (in/rev)	ap (inch)	vc (ft/min)	f (in/rev)	ap (inch)	vc (ft/min)	f (in/rev)	ap (inch)	vc (ft/min)	f (in/rev)	ap (inch)				

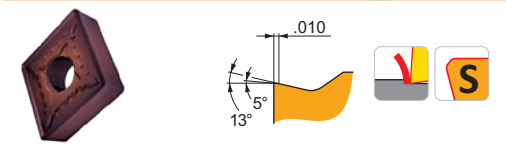

SM chip breaker is versatile and the first choice for medium machining of Steels and Super-alloys. It features slightly positive rake angle and stable, moderate T-land. It's also suitable for Stainless steels, Cast irons, and conditionally for Non-ferrous alloys and Hard materials.

CNMG 431-SM	T8415	.016	656	.0079	.079	344	.0071	.079	607	.0079	.079	1673	.0094	.079	148	.0071	.063	115	.0051	.013	8553061
CNMG 432-SM	T8415	.031	738	.0098	.079	377	.0089	.079	673	.0098	.079	1870	.0118	.079	164	.0079	.063	115	.0049	.026	8553067
CNMG 433-SM	T8415	.047	738	.0118	.079	377	.0106	.079	673	.0118	.079	1870	.0142	.079	164	.0094	.063	115	.0059	.039	8553070
CNMG 543-SM	T8415	.047	705	.0118	.118	361	.0106	.118	640	.0118	.118	1772	.0142	.118	148	.0106	.094	115	.0059	.039	8553072
CNMG 643-SM	T8415	.047	689	.0118	.157	361	.0106	.157	623	.0118	.157	1722	.0142	.157	148	.0106	.126	115	.0059	.039	8553074

■ Primary use ▣ Possible use



Suitability and starting values for cutting speed (vc), feed (f) and depth of cut (ap). Refer to our cutting conditions app for further options.

Product	RE (inch)	P			M			K			N			S			H			MID
		vc (ft/min)	f (in/rev)	ap (inch)	vc (ft/min)	f (in/rev)	ap (inch)	vc (ft/min)	f (in/rev)	ap (inch)	vc (ft/min)	f (in/rev)	ap (inch)	vc (ft/min)	f (in/rev)	ap (inch)	vc (ft/min)	f (in/rev)	ap (inch)	

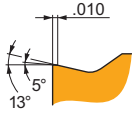

SM chip breaker is versatile and the first choice for medium machining of Steels and Super-alloys. It features slightly positive rake angle and stable, moderate T-land. It's also suitable for Stainless steels, Cast irons, and conditionally for Non-ferrous alloys and Hard materials.

DNMG 331-SM	T8415	.016	591	.0079	.031	295	.0071	.031	525	.0079	.031	1476	.0094	.031	131	.0071	.025	98	.0055	.013	8553082
DNMG 332-SM	T8415	.031	623	.0098	.047	328	.0089	.047	558	.0098	.047	1575	.0118	.047	131	.0079	.038	98	.0049	.026	8553087
DNMG 431-SM	T8415	.016	541	.0079	.067	279	.0071	.067	492	.0079	.067	1378	.0094	.067	115	.0071	.054	82	.0055	.013	8553089
DNMG 432-SM	T8415	.031	607	.0098	.067	312	.0089	.067	541	.0098	.067	1526	.0118	.067	131	.0079	.054	98	.0049	.026	8553091
DNMG 441-SM	T8415	.016	541	.0079	.067	279	.0071	.067	492	.0079	.067	1378	.0094	.067	115	.0071	.054	82	.0055	.013	8553096
DNMG 442-SM	T8415	.031	607	.0098	.067	312	.0089	.067	541	.0098	.067	1526	.0118	.067	131	.0079	.054	98	.0049	.026	8553103
DNMG 443-SM	T8415	.047	607	.0118	.067	312	.0106	.067	541	.0118	.067	1526	.0142	.067	131	.0094	.054	98	.0059	.035	8553105

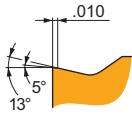
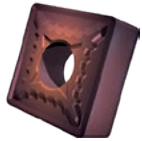

SM chip breaker is versatile and the first choice for medium machining of Steels and Super-alloys. It features slightly positive rake angle and stable, moderate T-land. It's also suitable for Stainless steels, Cast irons, and conditionally for Non-ferrous alloys and Hard materials.

SNMG 432-SM	T8415	.031	787	.0098	.071	410	.0089	.071	705	.0098	.071	1969	.0118	.071	180	.0079	.057	131	.0049	.026	8553111
SNMG 643-SM	T8415	.047	722	.0118	.157	377	.0106	.157	656	.0118	.157	1821	.0142	.157	164	.0106	.126	115	.0059	.039	8553115

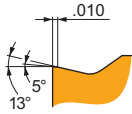

SM chip breaker is versatile and the first choice for medium machining of Steels and Super-alloys. It features slightly positive rake angle and stable, moderate T-land. It's also suitable for Stainless steels, Cast irons, and conditionally for Non-ferrous alloys and Hard materials.

TNMG 331-SM	T8415	.016	558	.0079	.067	295	.0071	.067	509	.0079	.067	1427	.0094	.067	115	.0071	.054	98	.0055	.013	8553124
TNMG 332-SM	T8415	.031	640	.0098	.067	328	.0089	.067	591	.0098	.067	1624	.0118	.067	148	.0079	.054	98	.0049	.026	8553131
TNMG 333-SM	T8415	.047	640	.0118	.067	328	.0106	.067	591	.0118	.067	1624	.0142	.067	148	.0094	.054	98	.0059	.035	8553133
TNMG 431-SM	T8415	.016	558	.0079	.067	295	.0071	.067	509	.0079	.067	1427	.0094	.067	115	.0071	.054	98	.0055	.013	8553135
TNMG 432-SM	T8415	.031	640	.0098	.067	328	.0089	.067	591	.0098	.067	1624	.0118	.067	148	.0079	.054	98	.0049	.026	8553138
TNMG 433-SM	T8415	.047	640	.0118	.067	328	.0106	.067	591	.0118	.067	1624	.0142	.067	148	.0094	.054	98	.0059	.035	8553140

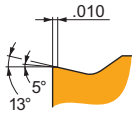

SM chip breaker is versatile and the first choice for medium machining of Steels and Super-alloys. It features slightly positive rake angle and stable, moderate T-land. It's also suitable for Stainless steels, Cast irons, and conditionally for Non-ferrous alloys and Hard materials.

VNMG 331-SM	T8415	.016	509	.0071	.047	262	.0064	.047	459	.0071	.047	1280	.0085	.047	115	.0064	.038	82	.005	.013	8553144
VNMG 332-SM	T8415	.031	525	.0098	.055	279	.0089	.055	476	.0098	.055	1329	.0118	.055	115	.0079	.044	82	.0049	.026	8553147

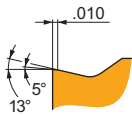
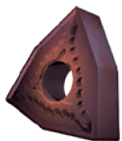

SM chip breaker is versatile and the first choice for medium machining of Steels and Super-alloys. It features slightly positive rake angle and stable, moderate T-land. It's also suitable for Stainless steels, Cast irons, and conditionally for Non-ferrous alloys and Hard materials.

WNMG 332-SM	T8415	.031	738	.0098	.067	377	.0089	.067	673	.0098	.067	1870	.0118	.067	164	.0079	.054	115	.0049	.026	8553155
WNMG 431-SM	T8415	.016	656	.0079	.079	344	.0071	.079	607	.0079	.079	1673	.0094	.079	148	.0071	.063	115	.0051	.013	8553161
WNMG 432-SM	T8415	.031	738	.0098	.079	377	.0089	.079	673	.0098	.079	1870	.0118	.079	164	.0079	.063	115	.0049	.026	8553166
WNMG 433-SM	T8415	.047	738	.0118	.079	377	.0106	.079	673	.0118	.079	1870	.0142	.079	164	.0094	.063	115	.0059	.039	8553168

SI

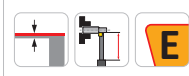
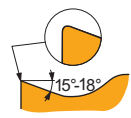

SI chip breaker is sharp and designed for medium machining of Steels, Stainless steels. It features positive rake angle without T-land. It's also conditionally suitable for Non-ferrous alloys and Super-alloys.



DNMG

	IC	D1	L	S
	(inch)	(inch)	(inch)	(inch)
44	.500	.203	.610	.250

TNMG

	IC	D1	L	S
	(inch)	(inch)	(inch)	(inch)
33	.375	.150	.650	.187

WNMG

	IC	D1	L	S
	(inch)	(inch)	(inch)	(inch)
43	.500	.203	.343	.187

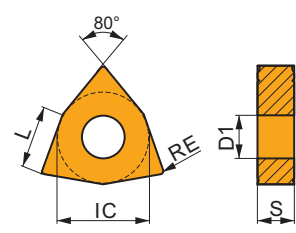
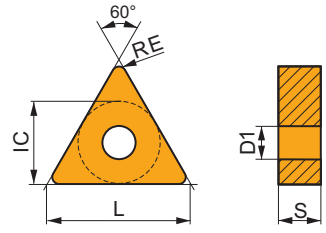
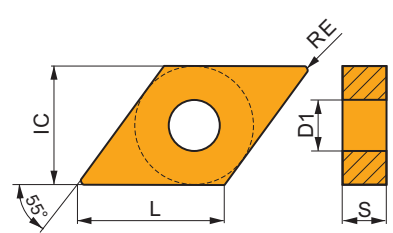

Suitability and starting values for cutting speed (vc), feed (f) and depth of cut (ap). Refer to our cutting conditions app for further options.

Product	RE (inch)	P			M			K			N			S			H			MID
		vc (ft/min)	f (in/rev)	ap (inch)	vc (ft/min)	f (in/rev)	ap (inch)	vc (ft/min)	f (in/rev)	ap (inch)	vc (ft/min)	f (in/rev)	ap (inch)	vc (ft/min)	f (in/rev)	ap (inch)	vc (ft/min)	f (in/rev)	ap (inch)	

				SI chip breaker is sharp and designed for medium machining of Steels, Stainless steels. It features positive rake angle without T-land. It's also conditionally suitable for Non-ferrous alloys and Super-alloys.																	
DNMG 441R-SI	T8415	.016	640	.0079	.059	328	.0071	.059	—	—	—	1624	.0094	.059	148	.0071	.047	—	—	—	8553094
DNMG 442R-SI	T8415	.031	656	.0138	.059	344	.0124	.059	—	—	—	1673	.0165	.059	148	.0096	.047	—	—	—	8553101

				SI chip breaker is sharp and designed for medium machining of Steels, Stainless steels. It features positive rake angle without T-land. It's also conditionally suitable for Non-ferrous alloys and Super-alloys.																	
DNMG 442L-SI	T8415	.031	656	.0138	.059	344	.0124	.059	—	—	—	1673	.0165	.059	148	.0096	.047	—	—	—	8553099





				SI chip breaker is sharp and designed for medium machining of Steels, Stainless steels. It features positive rake angle without T-land. It's also conditionally suitable for Non-ferrous alloys and Super-alloys.																	
TNMG 331R-SI	T8415	.016	689	.0079	.059	361	.0071	.059	—	—	—	1722	.0094	.059	148	.0071	.047	—	—	—	8553122
TNMG 332R-SI	T8415	.031	705	.0138	.059	361	.0124	.059	—	—	—	1772	.0165	.059	148	.0096	.047	—	—	—	8553129

				SI chip breaker is sharp and designed for medium machining of Steels, Stainless steels. It features positive rake angle without T-land. It's also conditionally suitable for Non-ferrous alloys and Super-alloys.																	
TNMG 331L-SI	T8415	.016	689	.0079	.059	361	.0071	.059	—	—	—	1722	.0094	.059	148	.0071	.047	—	—	—	8553121
TNMG 332L-SI	T8415	.031	705	.0138	.059	361	.0124	.059	—	—	—	1772	.0165	.059	148	.0096	.047	—	—	—	8553127

■ Primary use ▣ Possible use

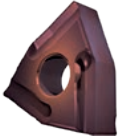
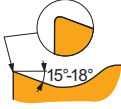

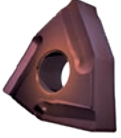
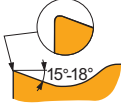
Suitability and starting values for cutting speed (vc), feed (f) and depth of cut (ap). Refer to our cutting conditions app for further options.

Product	RE (inch)	P			M			K			N			S			H			MID		
		vc (ft/min)	f (in/rev)	ap (inch)	vc (ft/min)	f (in/rev)	ap (inch)	vc (ft/min)	f (in/rev)	ap (inch)	vc (ft/min)	f (in/rev)	ap (inch)	vc (ft/min)	f (in/rev)	ap (inch)	vc (ft/min)	f (in/rev)	ap (inch)			
   <p>SI chip breaker is sharp and designed for medium machining of Steels, Stainless steels. It features positive rake angle without T-land. It's also conditionally suitable for Non-ferrous alloys and Super-alloys.</p>	WNGM 431R-SI	T8415	.016	820	.0079	.067	427	.0071	.067	—	—	—	2067	.0094	.067	180	.0071	.054	—	—	—	8553159
	   <p>SI chip breaker is sharp and designed for medium machining of Steels, Stainless steels. It features positive rake angle without T-land. It's also conditionally suitable for Non-ferrous alloys and Super-alloys.</p>	WNGM 431L-SI	T8415	.016	820	.0079	.067	427	.0071	.067	—	—	—	2067	.0094	.067	180	.0071	.054	—	—	—



NM

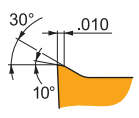

NM chip breaker is sharp and designed for medium machining of Steels, Stainless steels and Super-alloys. It features highly positive rake angle and positive, moderate T-land. It's also conditionally suitable for Non-ferrous alloys.



CNMG

	IC	D1	L	S
	(inch)	(inch)	(inch)	(inch)
43	.500	.203	.508	.187

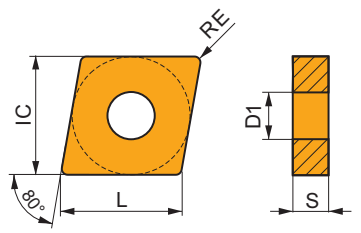

DNMG

	IC	D1	L	S
	(inch)	(inch)	(inch)	(inch)
33	.375	.150	.457	.187
43	.500	.203	.610	.187

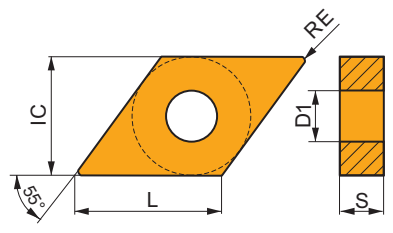

TNMG

	IC	D1	L	S
	(inch)	(inch)	(inch)	(inch)
33	.375	.150	.650	.187
43	.500	.203	.866	.187

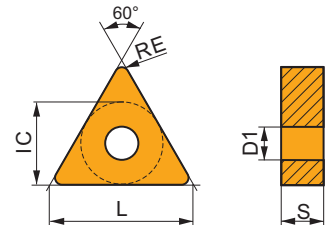

VNMG

	IC	D1	L	S
	(inch)	(inch)	(inch)	(inch)
33	.375	.150	.654	.187

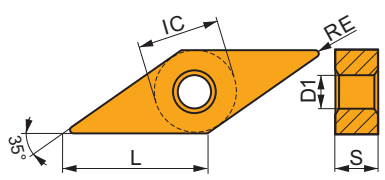

WNMG

	IC	D1	L	S
	(inch)	(inch)	(inch)	(inch)
43	.500	.203	.343	.187

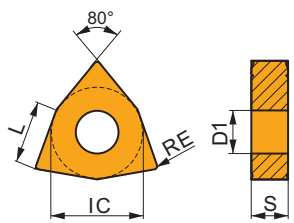

■ Primary use ▣ Possible use



Suitability and starting values for cutting speed (vc), feed (f) and depth of cut (ap). Refer to our cutting conditions app for further options.

Product	RE (inch)	P			M			K			N			S			H			MID
		vc	f	ap	vc	f	ap	vc	f	ap	vc	f	ap	vc	f	ap	vc	f	ap	
		(ft/min)	(in/rev)	(inch)	(ft/min)	(in/rev)	(inch)	(ft/min)	(in/rev)	(inch)	(ft/min)	(in/rev)	(inch)	(ft/min)	(in/rev)	(inch)	(ft/min)	(in/rev)	(inch)	

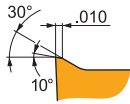
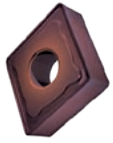

NM chip breaker is sharp and designed for medium machining of Steels, Stainless steels and Super-alloys. It features highly positive rake angle and positive, moderate T-land. It's also conditionally suitable for Non-ferrous alloys.

CNMG 432-NM	T8415	.031	804	.0098	.083	410	.0089	.083	-	-	-	2018	.0118	.083	180	.0079	.066	-	-	-	8553064
--------------------	--------------	------	-----	-------	------	-----	-------	------	---	---	---	------	-------	------	-----	-------	------	---	---	---	---------

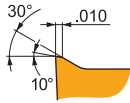
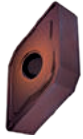

NM chip breaker is sharp and designed for medium machining of Steels, Stainless steels and Super-alloys. It features highly positive rake angle and positive, moderate T-land. It's also conditionally suitable for Non-ferrous alloys.

DNMG 332-NM	T8415	.031	705	.0098	.031	361	.0089	.031	-	-	-	1772	.0118	.031	148	.0079	.025	-	-	-	8553085
--------------------	--------------	------	-----	-------	------	-----	-------	------	---	---	---	------	-------	------	-----	-------	------	---	---	---	---------

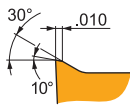
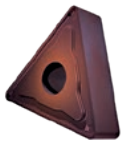

NM chip breaker is sharp and designed for medium machining of Steels, Stainless steels and Super-alloys. It features highly positive rake angle and positive, moderate T-land. It's also conditionally suitable for Non-ferrous alloys.

TNMG 332-NM	T8415	.031	705	.0098	.075	361	.0089	.075	-	-	-	1772	.0118	.075	148	.0079	.06	-	-	-	8553128
--------------------	--------------	------	-----	-------	------	-----	-------	------	---	---	---	------	-------	------	-----	-------	-----	---	---	---	---------

TNMG 432-NM	T8415	.031	705	.0098	.067	361	.0089	.067	-	-	-	1772	.0118	.067	148	.0079	.054	-	-	-	8553136
--------------------	--------------	------	-----	-------	------	-----	-------	------	---	---	---	------	-------	------	-----	-------	------	---	---	---	---------

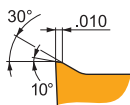

NM chip breaker is sharp and designed for medium machining of Steels, Stainless steels and Super-alloys. It features highly positive rake angle and positive, moderate T-land. It's also conditionally suitable for Non-ferrous alloys.

VNMG 331-NM	T8415	.016	525	.0079	.047	279	.0071	.047	-	-	-	1329	.0094	.047	115	.0079	.038	-	-	-	8553142
--------------------	--------------	------	-----	-------	------	-----	-------	------	---	---	---	------	-------	------	-----	-------	------	---	---	---	---------

VNMG 332-NM	T8415	.031	591	.0098	.055	295	.0089	.055	-	-	-	1476	.0118	.055	131	.0079	.044	-	-	-	8553145
--------------------	--------------	------	-----	-------	------	-----	-------	------	---	---	---	------	-------	------	-----	-------	------	---	---	---	---------

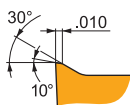
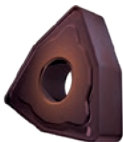

NM chip breaker is sharp and designed for medium machining of Steels, Stainless steels and Super-alloys. It features highly positive rake angle and positive, moderate T-land. It's also conditionally suitable for Non-ferrous alloys.

WNMG 433-NM	T8415	.047	804	.0118	.083	410	.0106	.083	-	-	-	2018	.0142	.083	180	.0094	.066	-	-	-	8553167
--------------------	--------------	------	-----	-------	------	-----	-------	------	---	---	---	------	-------	------	-----	-------	------	---	---	---	---------



NMA

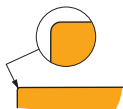

..A flat insert is designed for medium machining of Cast irons. It features neutral rake angle without T-land. It's also conditionally suitable for Hard materials.



CNMA

	IC	D1	L	S
	(inch)	(inch)	(inch)	(inch)
 43	.500	.203	.508	.187

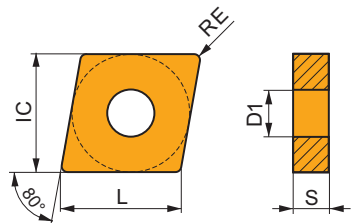

DNMA

	IC	D1	L	S
	(inch)	(inch)	(inch)	(inch)
 44	.500	.203	.610	.250

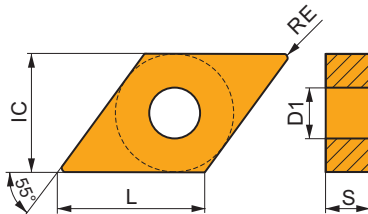

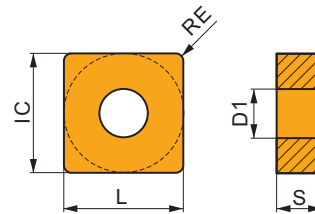

SNMA

	IC	D1	L	S
	(inch)	(inch)	(inch)	(inch)
 43	.500	.203	.500	.187



TNMA

	IC	D1	L	S
	(inch)	(inch)	(inch)	(inch)
 33	.375	.150	.650	.187
 43	.500	.203	.866	.187

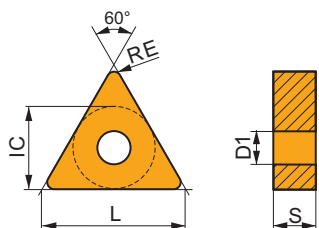

WNMA

	IC	D1	L	S
	(inch)	(inch)	(inch)	(inch)
 43	.500	.203	.343	.187

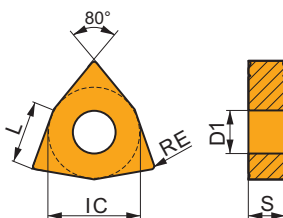



Suitability and starting values for cutting speed (vc), feed (f) and depth of cut (ap). Refer to our cutting conditions app for further options.

Product	RE (inch)	P			M			K			N			S			H			MID
		vc (ft/min)	f (in/rev)	ap (inch)	vc (ft/min)	f (in/rev)	ap (inch)	vc (ft/min)	f (in/rev)	ap (inch)	vc (ft/min)	f (in/rev)	ap (inch)	vc (ft/min)	f (in/rev)	ap (inch)	vc (ft/min)	f (in/rev)	ap (inch)	

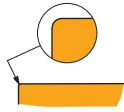
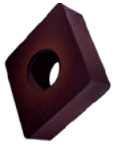

..A flat insert is designed for medium machining of Cast irons. It features neutral rake angle without T-land. It's also conditionally suitable for Hard materials.

CNMA 432	T8415	.031	-	-	-	-	-	-	476	.0079	.157	-	-	-	-	-	-	82	.0055	.02	8552986
CNMA 433	T8415	.047	-	-	-	-	-	-	443	.0118	.157	-	-	-	-	-	-	82	.0083	.02	8552987

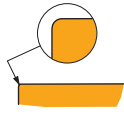

..A flat insert is designed for medium machining of Cast irons. It features neutral rake angle without T-land. It's also conditionally suitable for Hard materials.

DNMA 441	T8415	.016	-	-	-	-	-	-	427	.0039	.067	-	-	-	-	-	-	82	.0028	.02	8553076
DNMA 442	T8415	.031	-	-	-	-	-	-	410	.0079	.067	-	-	-	-	-	-	66	.0055	.02	8553077

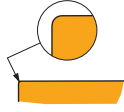
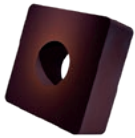

..A flat insert is designed for medium machining of Cast irons. It features neutral rake angle without T-land. It's also conditionally suitable for Hard materials.

SNMA 432	T8415	.031	-	-	-	-	-	-	492	.0079	.157	-	-	-	-	-	-	82	.0055	.02	8553106
----------	-------	------	---	---	---	---	---	---	-----	-------	------	---	---	---	---	---	---	----	-------	-----	---------

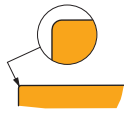
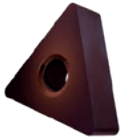

..A flat insert is designed for medium machining of Cast irons. It features neutral rake angle without T-land. It's also conditionally suitable for Hard materials.

TNMA 332	T8415	.031	-	-	-	-	-	-	443	.0079	.059	-	-	-	-	-	-	82	.0055	.02	8553117
TNMA 432	T8415	.031	-	-	-	-	-	-	427	.0079	.079	-	-	-	-	-	-	82	.0055	.02	8553118

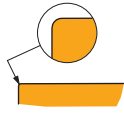
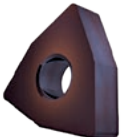

..A flat insert is designed for medium machining of Cast irons. It features neutral rake angle without T-land. It's also conditionally suitable for Hard materials.

WNMA 432	T8415	.031	-	-	-	-	-	-	476	.0079	.157	-	-	-	-	-	-	82	.0055	.02	8553148
WNMA 433	T8415	.047	-	-	-	-	-	-	443	.0118	.157	-	-	-	-	-	-	82	.0083	.02	8553149



RM

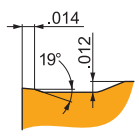

RM chip breaker is robust and the first choice for roughing of Steels. It features positive rake angle and stable, wide T-land. It's also suitable for Stainless steels, Cast irons, and conditionally for Super-alloys.



CNMG

	IC	D1	L	S
	(inch)	(inch)	(inch)	(inch)
43	.500	.203	.508	.187
54	.625	.250	.634	.250
64	.750	.313	.760	.250

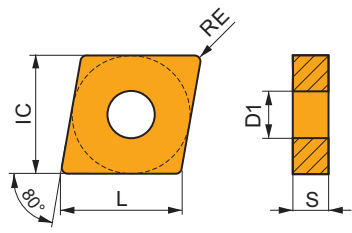

DNMG

	IC	D1	L	S
	(inch)	(inch)	(inch)	(inch)
44	.500	.203	.610	.250

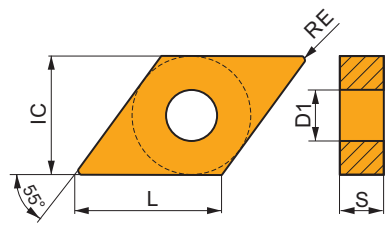

SNMG

	IC	D1	L	S
	(inch)	(inch)	(inch)	(inch)
43	.500	.203	.500	.187
54	.625	.250	.625	.250
64	.750	.313	.750	.250

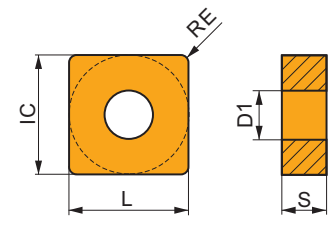

WNMG

	IC	D1	L	S
	(inch)	(inch)	(inch)	(inch)
43	.500	.203	.343	.187

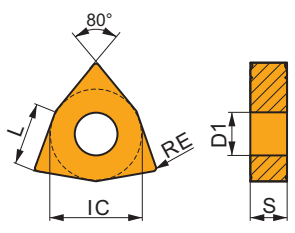



Suitability and starting values for cutting speed (vc), feed (f) and depth of cut (ap). Refer to our cutting conditions app for further options.

Product	RE (inch)	P			M			K			N			S			H			MID
		vc (ft/min)	f (in/rev)	ap (inch)	vc (ft/min)	f (in/rev)	ap (inch)	vc (ft/min)	f (in/rev)	ap (inch)	vc (ft/min)	f (in/rev)	ap (inch)	vc (ft/min)	f (in/rev)	ap (inch)	vc (ft/min)	f (in/rev)	ap (inch)	

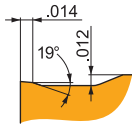

RM chip breaker is robust and the first choice for roughing of Steels. It features positive rake angle and stable, wide T-land. It's also suitable for Stainless steels, Cast irons, and conditionally for Super-alloys.

CNMG 432-RM	T8415	.031	640	.0157	.157	328	.0142	.157	591	.0157	.157	–	–	–	148	.011	.126	–	–	–	8553065
CNMG 433-RM	T8415	.047	656	.0177	.157	344	.0159	.157	607	.0177	.157	–	–	–	148	.0124	.126	–	–	–	8553068
CNMG 543-RM	T8415	.047	640	.0177	.236	328	.0159	.236	591	.0177	.236	–	–	–	148	.0124	.189	–	–	–	8553071
CNMG 643-RM	T8415	.047	640	.0177	.295	328	.0159	.295	591	.0177	.295	–	–	–	148	.0124	.236	–	–	–	8553073
CNMG 644-RM	T8415	.063	640	.0197	.295	328	.0177	.295	591	.0197	.295	–	–	–	148	.0138	.236	–	–	–	8553075

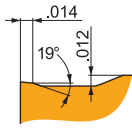

RM chip breaker is robust and the first choice for roughing of Steels. It features positive rake angle and stable, wide T-land. It's also suitable for Stainless steels, Cast irons, and conditionally for Super-alloys.

DNMG 442-RM	T8415	.031	525	.0157	.118	279	.0142	.118	476	.0157	.118	–	–	–	115	.011	.094	–	–	–	8553100
--------------------	--------------	------	-----	-------	------	-----	-------	------	-----	-------	------	---	---	---	-----	------	------	---	---	---	---------

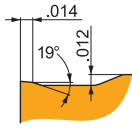
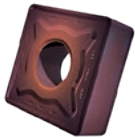

RM chip breaker is robust and the first choice for roughing of Steels. It features positive rake angle and stable, wide T-land. It's also suitable for Stainless steels, Cast irons, and conditionally for Super-alloys.

SNMG 432-RM	T8415	.031	689	.0157	.157	361	.0142	.157	623	.0157	.157	–	–	–	148	.011	.126	–	–	–	8553109
SNMG 433-RM	T8415	.047	705	.0177	.157	361	.0159	.157	640	.0177	.157	–	–	–	148	.0124	.126	–	–	–	8553112
SNMG 543-RM	T8415	.047	705	.0177	.197	361	.0159	.197	640	.0177	.197	–	–	–	148	.0124	.157	–	–	–	8553114
SNMG 644-RM	T8415	.063	689	.0197	.276	361	.0177	.276	623	.0197	.276	–	–	–	148	.0138	.22	–	–	–	8553116

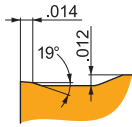
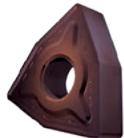

RM chip breaker is robust and the first choice for roughing of Steels. It features positive rake angle and stable, wide T-land. It's also suitable for Stainless steels, Cast irons, and conditionally for Super-alloys.

WNMG 432-RM	T8415	.031	640	.0157	.157	328	.0142	.157	591	.0157	.157	–	–	–	148	.011	.126	–	–	–	8553164
--------------------	--------------	------	-----	-------	------	-----	-------	------	-----	-------	------	---	---	---	-----	------	------	---	---	---	---------



SSO12 VERSATILE HIGH FEED MILLING

INTRODUCTION





Introducing Pramet SSO12 – a new versatile high-feed milling family tailored for challenging workpieces in die and mold industry. Reliable tools with low vibrations, reduced noise, and exceptional power efficiency. Experience smooth cutting action, extended tool life, and significant energy savings – a smart investment into versatility and performance.



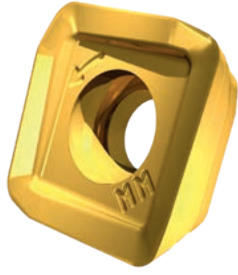

SOHT-M

- Versatile 4-edged HFC insert
- Steels, Cast irons, Hard steels
- Medium up to rough cuts

SOHT-MM

- Sharp 4-edged HFC insert
- Soft steels, Stainless steels, HRSA
- Light up to medium cuts



MILLING CUTTERS AND INSERTS

INSERTS FEATURES & BENEFITS

Two reliable geometries M with neutral T-land and MM with positive T-land design.



EASY TO CHOOSE, SIMPLE TO USE
M for strong materials, MM for soft materials.

Precisely ground positive flank and negative seating flats improves clamping stability.



LONG TOOL LIFE AND CONSISTENCY
in any high feed milling operation.

Positive axial setting angle and positive rake angle and T-land.



PERFECT CHIP EVACUATION UPWARDS
makes it ideal for deep pocketing and milling across holes.

Precise cutters with low runout prevent overcutting of chips against the wall.



SMOOTH WALL SURFACE FINISH,
no more chips sticking on the wall.

Long and highly positive wiper edge parallel to both face and wall.



SMOOTH FACE FINISH
after face milling operations.





SSO12 VERSATILE HIGH FEED MILLING

CUTTERS SSO12 – FEATURES & BENEFITS

- Optimized shape of insert pocket. ▶ **SIMPLE INDEXING**
and handling of insert.

- Optimized shape of tooth pocket in balance with dense teeth pitch. ▶ **SECURE CHIP EVACUATION**
in any HFC milling application.

- Connection diameter of shell mills according to standard arbor connection diameter. ▶ **RELIABLE TRANSMISSION OF TORQUE**
from spindle until the cutting edge.

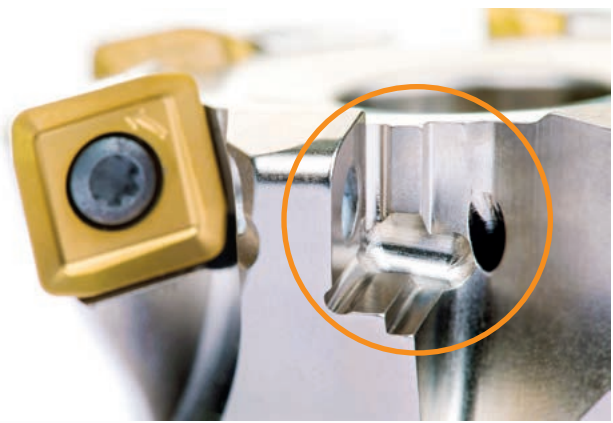

Easily accessible large clamping screws.



SSO12

- Modular shank
- Imperial range: 1.50"
- Metric range: 35 – 40 mm



SSO12

- Cylindrical shank
- Imperial range: 1.50"
- Metric range: 35 – 40 mm



SSO12

- Shell body
- Imperial range: 2.0 – 5.0"
- DC range: 42 – 125 mm



HIGH FEED MILLING EXAMPLES

Workpiece: Steel plate face milling
Material: S355NL / 1.0546 (160 HB)
Cutter: 63A06R-SMOSO12-C
Coolant: No (just pressed air)

Cutting conditions:

v_c	f_z	a_p	a_e	TOH
820 (250)	.038 (0.96)	.024 (0.6)	1.732 (44)	6.3 (160)

Insert geometry test

Tool life

SOHT 120514SR-MM:M8330

175 min (+133%)



WMG P2.1

Pramet SSO12 runs significantly smoother than competitor, and according to small wear it would last many more minutes. Even faster table feed rate $F = 10\ 800\ \text{mm/min}$ (+50%) was tested, still completely stable and fluent cutting!

Workpiece: Stainless steel turbine blade
Material: 1.4301 / X5CrNi18 – 10 / SUS304 (170 HB)
Cutter: 50A05R-SMOSO12-C
Coolant: Yes (external, soluble oil emulsion)

Cutting conditions:

v_c	f_z	a_p	a_e	TOH
410 (125)	.012 (0.31)	.039 (1.0)	.689 (17.5)	5.5 (140)

Insert geometry test

Tool life

SOHT 120514SR-MM:M6330

35 min (+133%)



WMG M3.1

All competing cutters were all the time buried in chips, there were sudden breakages of inserts and cutters happening. Pramet SSO12 finished the job thanks to improved chip evacuation.

Workpiece: Cast steel face and copy milling
Material: G20Mn6N / 1.6220 (180 HB)
Cutter: 63A06R-SMOSO12-C
Coolant: No (just pressed air)

Cutting conditions:

v_c	f_z	a_p	a_e	TOH
843 (257)	.025 (0.64)	.055 (1.4)	2.362 (60)	2.4 (60)

Insert geometry test

Tool life

SOHT 120514SR-M:8215

56 min (+35%)



WMG P3.1

Pramet SSO12 cutters achieved better tool life, beating the competitor by making four workpieces instead of just three!

Workpiece: Base plate for wind turbine
Material: 26NiCrMoV11-5 / 1.6948 (360 HB)
Cutter: 63A06R-SMOSO12-C
Coolant: No (just pressed air)

Cutting conditions:

v_c	f_z	a_p	a_e	TOH
531 (162)	.061 (1.55)	.026 (0.65)	1.496 (38)	5.5 (140)

Insert geometry test

Tool life

SOHT 120514SR-M:M8330

150 min (+42%)



WMG P3.3

Pramet SSO12 solution increased tool life to 142% and achieved better surface quality ($Ra\ 1.0$) than competitor.

(I)SSO12



PRAMET

S

VER S012 12° High Feed Milling with Internal Coolant

Highly versatile 12° high feed mill utilising single sided SO.. 12 style inserts with APMX of .075 in (1.9 mm). Suited for a wide range of applications in most workpiece materials. Cylindrical, modular and arbor style available, with differential tooth pitch. Coolant through channels and body treated for longer tool life.



KAPR	12°
APMX	.075 in (1.9 mm)

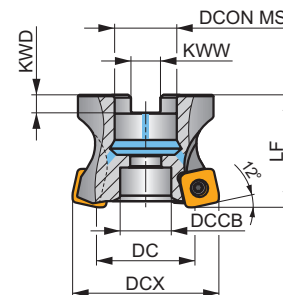
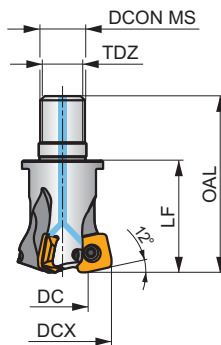
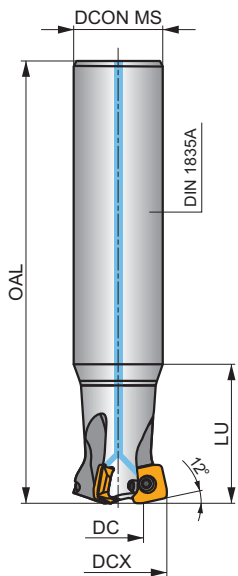
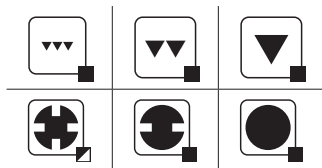
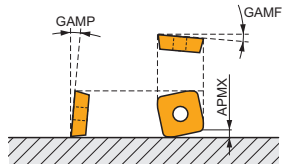

	.004 – .037 in 0.09 – 0.93 mm
	.004 – .037 in 0.09 – 0.93 mm



Product	DCX	DC	OAL	DCON MS	DCCB	LU	LF	TDZ	KWW	KWD	GAMP	GAMP	max.	lbs	MID					
	(inch)	(inch)	(inch)	(inch)	(inch)	(inch)	(inch)	(inch)	(inch)	(inch)	(°)	(°)								
150E3R472C125-ISSO12-C	1.500	.803	7.874	1.250	-	4.724	-	-	-	-	-5	5	3	-	15000	✓	2.18	GI350	SQ501	8551876
150E4R472C125-ISSO12-C	1.500	.803	7.874	1.250	-	4.724	-	-	-	-	-5	5	4	-	15000	✓	2.18	GI350	SQ501	8551877
150E3R170M16-ISSO12-C	1.500	.803	2.598	.669	-	-	1.693	M16	-	-	-5	5	3	-	15000	✓	.37	GI350	SQ501	8551878
150E4R170M16-ISSO12-C	1.500	.803	2.598	.669	-	-	1.693	M16	-	-	-5	5	4	-	15000	✓	.37	GI350	SQ501	8551879
200A05R-ISMOSO12-C	2.000	1.303	-	.750	.630	-	1.575	-	.321	.193	-5	5	5	✓	13000	✓	.57	GI350	SQ506	8551880
250A06R-ISMOSO12-C	2.500	1.803	-	.750	.630	-	1.575	-	.321	.193	-5	5	6	✓	11600	✓	.84	GI350	SQ506	8551881
300A07R-ISMOSO12-C	3.000	2.303	-	1.000	.827	-	1.969	-	.382	.224	-5	5	7	✓	10600	✓	1.76	GI350	SQ507	8551882
400A08R-ISMOSO12-C	4.000	3.303	-	1.500	1.417	-	1.969	-	.630	.382	-5	5	8	✓	9200	✓	3.55	GI350	SQ508	8551883
500A10R-ISMOSO12-C	5.000	4.303	-	1.500	1.417	-	2.480	-	.630	.382	-5	5	10	✓	8200	✓	6.15	GI350	SQ508	8551884

Product	DCX	DC	OAL	DCON MS	DCCB	LU	LF	TDZ	KWW	KWD	GAMP	GAMP	max.	lbs	MID						
	(mm)	(mm)	(mm)	(mm)	(mm)	(mm)	(mm)	(mm)	(mm)	(mm)	(°)	(°)									
35E3R050A32-SSO12-C	35	17.3	200	32	-	50	-	-	-	-	-5	5	3	-	15700	✓	2.36	GI350	SQ501	-	8551763
35E3R120A32-SSO12-C	35	17.3	200	32	-	120	-	-	-	-	-5	5	3	-	15700	✓	2.09	GI350	SQ501	-	8551764
40E4R120A32-SSO12-C	40	22.3	200	32	-	120	-	-	-	-	-5	5	4	-	14700	✓	3.22	GI350	SQ501	-	8551765
35E3R040M16-SSO12-C	35	17.3	63	17	-	-	40	M16	-	-	-5	5	3	-	15700	✓	.33	GI350	SQ501	-	8551766
40E4R043M16-SSO12-C	40	22.3	66	17	-	-	43	M16	-	-	-5	5	4	-	14700	✓	.40	GI350	SQ501	-	8551767
42A04R-SMOSO12-C	42	24.3	-	16	12.4	-	40	-	8.4	5.6	-5	5	4	-	14300	✓	.35	GI350	SQ502	-	8551768
50A05R-SMOSO12-C	50	32.3	-	22	18.1	-	40	-	10.4	6.3	-5	5	5	✓	13100	✓	.51	GI350	SQ503	-	8551769
52A05R-SMOSO12-C	52	34.3	-	22	18.1	-	40	-	10.4	6.3	-5	5	5	✓	12800	✓	.55	GI350	SQ503	-	8551870
63A06R-SMOSO12-C	63	45.3	-	27	22.1	-	50	-	12.4	7	-5	5	6	✓	11700	✓	1.06	GI350	SQ504	-	8551871
66A06R-SMOSO12-C	66	48.3	-	27	22.1	-	50	-	12.4	7	-5	5	6	✓	11400	✓	1.12	GI350	SQ504	-	8551872
80A07R-SMOSO12-C	80	62.3	-	27	22.1	-	50	-	12.4	7	-5	5	7	✓	10400	✓	1.68	GI350	SQ504	-	8551873
100A08R-SMOSO12-C	100	82.3	-	32	45.1	-	50	-	14.4	8	-5	5	8	✓	9300	✓	2.91	GI350	SQ505	AC002	8551874
125A10R-SMOSO12-C	125	107.3	-	40	56.1	-	63	-	16.4	9	-5	5	10	✓	8300	✓	5.42	GI350	SQ505	AC003	8551875



GI350

SOHT 1205..



SQ501

US 4011-T15P

3.5

M 4

0.417

FLAG T15P

-

-

SQ506

US 4011-T15P

3.5

M 4

0.417

SDR T15P-T

HS 037100

SQ507

US 4011-T15P

3.5

M 4

0.417

SDR T15P-T

HS 050125

SQ508

US 4011-T15P

3.5

M 4

0.417

SDR T15P-T

HCS 075175

SOHT 12



IC

D1

S

(inch)

(inch)

(inch)

1205

.500

.177

.203

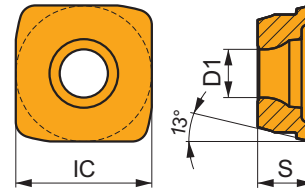

Suitability and starting values for cutting speed (vc), feed (f) and depth of cut (ap). Refer to our cutting conditions app for further options.

Product	RE (inch)	P			M			K			N			S			H			MID
		vc (ft/min)	f (in/tooth)	ap (inch)	vc (ft/min)	f (in/tooth)	ap (inch)	vc (ft/min)	f (in/tooth)	ap (inch)	vc (ft/min)	f (in/tooth)	ap (inch)	vc (ft/min)	f (in/tooth)	ap (inch)	vc (ft/min)	f (in/tooth)	ap (inch)	

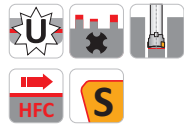
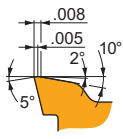

M geometry is versatile for a wide range of working conditions. Designed with positive rake, medium T-land and rounding of cutting edge for smooth HFC milling. First choice for steels, cast irons and hardened steels.

SOHT 120514SR-M:8215	.055	705	.0394	.039	410	.0354	.039	656	.0394	.039	-	-	-	164	.0276	.031	131	.0268	.031	8551713
SOHT 120514SR-M:M8310	.055	738	.0394	.039	361	.0354	.039	689	.0394	.039	-	-	-	-	-	-	148	.0268	.031	8551714
SOHT 120514SR-M:M8330	.055	722	.0394	.039	427	.0354	.039	673	.0394	.039	-	-	-	180	.0276	.031	131	.0268	.031	8551715
SOHT 120514SR-M:M8340	.055	673	.0394	.039	394	.0354	.039	623	.0394	.039	-	-	-	164	.0276	.031	-	-	-	8551716
SOHT 120514SR-M:M9325	.055	804	.0394	.039	-	-	-	755	.0394	.039	-	-	-	-	-	-	148	.0268	.031	8551717
SOHT 120514SR-M:M9340	.055	705	.0394	.039	410	.0354	.039	-	-	-	-	-	-	164	.0276	.031	-	-	-	8551718

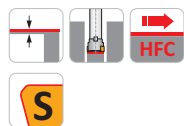
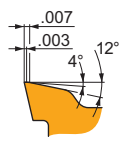

MM geometry is sharp and suitable for large overhang or thin walled and slim workpiece applications. Designed with positive rake, narrow T-land and rounding of cutting edge for smooth HFC milling. First choice for stainless steels and super alloys.

SOHT 120514SR-MM:M6330	.055	623	.0394	.039	443	.0354	.039	-	-	-	-	-	-	180	.0276	.031	-	-	-	8551742
SOHT 120514SR-MM:M8340	.055	673	.0394	.039	394	.0354	.039	-	-	-	-	-	-	164	.0276	.031	-	-	-	8551743
SOHT 120514SR-MM:M8345	.055	541	.0394	.039	312	.0354	.039	-	-	-	-	-	-	131	.0276	.031	-	-	-	8551744
SOHT 120514SR-MM:M9325	.055	804	.0394	.039	-	-	-	-	-	-	-	-	-	-	-	-	-	-	-	8551747
SOHT 120514SR-MM:M9340	.055	705	.0394	.039	410	.0354	.039	-	-	-	-	-	-	164	.0276	.031	-	-	-	8551748

■ Primary use ▣ Possible use



(inch)



SOHT	R	T
SOHT 120514	.133	.047



(mm)



SOHT	R	T
SOHT 120514	3.37	1.21



a_e / DCX	5%	10%	15%	20%	25%	30%	40%	50%	60%	70%	75%	80%	90%	100%
	1.48	1.35	1.27	1.22	1.19	1.16	1.11	1.08	1.05	1.03	1.00	1.00	1.00	1.00
	2.20	1.60	1.35	1.20	1.10	.95	.85	.75	.85	.95	1.00	1.00	1.00	1.00
	.64	.64	.64	.64	.64	.65	.65	.67	.68	.71	.72	.74	.79	1.00

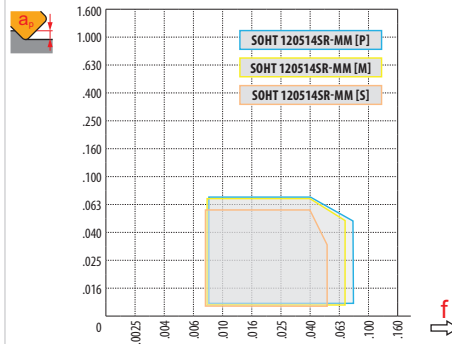
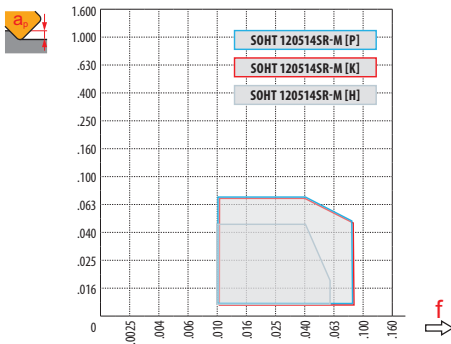

	SOHT 12-M	SOHT 12-MM
	.055	.055
	.079	.079
	1.4	1.4
	2.00	2.00



a_e	.008	.024	.040	.060	.075
	.079	.063	.048	.032	.020



a_e	0.2	0.6	1.0	1.5	1.9
	2.0	1.6	1.2	0.8	0.5



DCX	DMIN	DMAX		
1.500	2.039	2.992	.075	.075
2.000	3.031	3.992	.075	.075
2.500	4.031	4.992	.075	.075
3.000	5.031	5.992	.075	.075
4.000	7.031	7.992	.075	.075
5.000	9.031	9.992	.075	.075



DCX	RPMX	APMX/I
1.500	6.9	.075/1.551
2.000	4.2	.075/1.023
2.500	2.6	.075/1.653
3.000	2.0	.075/2.165
4.000	1.3	.075/3.196
5.000	1.0	.075/3.937



DCX	a_e	f_{max}
1.500	.063	.007
2.000	.063	.004
2.500	.063	.002
3.000	.063	.002
4.000	.063	.002
5.000	.063	.002

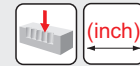

DCX	$a_{e,max}$	f_{max}
1.500	.394	.004
2.000	.394	.005
2.500	.394	.006
3.000	.394	.008
4.000	.394	.008
5.000	.394	.008



DCX	DMIN	DMAX		
35	46.0	69.8	1.9	1.9
40	56.0	79.8	1.9	1.9
42	60.0	83.8	1.9	1.9
50	76.0	99.8	1.9	1.9
52	80.0	103.8	1.9	1.9
63	102.0	125.8	1.9	1.9
66	108.0	131.8	1.9	1.9
80	136.0	159.8	1.9	1.9
100	176.0	199.8	1.9	1.9
125	226.0	249.8	1.9	1.9



DCX	RPMX	APMX/I
35	9.6	1.9/11
40	6.9	1.9/16
42	6.1	1.9/18
50	4.3	1.9/25
52	4.0	1.9/27
63	2.6	1.9/41
66	2.5	1.9/44
80	1.9	1.9/59
100	1.4	1.9/79
125	1.0	1.9/105

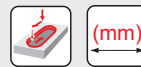

DCX	a_e	f_{max}
35	1.6	0.17
40	1.6	0.17
42	1.6	0.15
50	1.6	0.10
52	1.6	0.10
63	1.6	0.05
66	1.6	0.05
80	1.6	0.05
100	1.6	0.05
125	1.6	0.05

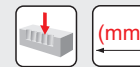

DCX	$a_{e,max}$	f_{max}
35	10.0	0.10
40	10.0	0.10
42	10.0	0.12
50	10.0	0.12
52	10.0	0.12
63	10.0	0.15
66	10.0	0.15
80	10.0	0.20
100	10.0	0.20
125	10.0	0.20

(inch)		HFC												
DCX		.00	.008	.016	.024	.032	.040	.048	.056	.060	.063	.067	.071	.075
1.500		.803	.878	.952	1.026	1.100	1.174	1.248	1.322	1.359	1.396	1.425	1.443	1.455
2.000		1.303	1.378	1.452	1.526	1.600	1.674	1.748	1.822	1.859	1.896	1.925	1.943	1.955
2.500		1.803	1.878	1.952	2.026	2.100	2.174	2.248	2.322	2.359	2.396	2.425	2.443	2.455
3.000		2.303	2.378	2.452	2.526	2.600	2.674	2.748	2.822	2.859	2.896	2.925	2.943	2.955
4.000		3.303	3.378	3.452	3.526	3.600	3.674	3.748	3.822	3.859	3.896	3.925	3.943	3.955
5.000		4.303	4.378	4.452	4.526	4.600	4.674	4.748	4.822	4.859	4.896	4.925	4.943	4.955
		.00	.008	.016	.024	.032	.040	.048	.056	.060	.063	.067	.071	.075
		-	.087	.079	.071	.063	.056	.048	.044	.040	.036	.032	.028	.024

(mm)		HFC												
DCX		0.00	0.20	0.40	0.60	0.80	1.00	1.20	1.40	1.50	1.60	1.70	1.80	1.90
35		17.3	19.2	21.1	22.9	24.8	26.7	28.6	30.5	31.4	32.4	33.1	33.5	33.9
40		22.3	24.2	26.1	27.9	29.8	31.7	33.6	35.5	36.4	37.4	38.1	38.5	38.9
42		24.3	26.2	28.1	29.9	31.8	33.7	35.6	37.5	38.4	39.4	40.1	40.5	40.9
50		32.3	34.2	36.1	37.9	39.8	41.7	43.6	45.5	46.4	47.4	48.1	48.5	48.9
52		34.3	36.2	38.1	39.9	41.8	43.7	45.6	47.5	48.4	49.4	50.1	50.5	50.9
63		45.3	47.2	49.1	50.9	52.8	54.7	56.6	58.5	59.4	60.4	61.1	61.5	61.9
66		48.3	50.2	52.1	53.9	55.8	57.7	59.6	61.5	62.4	63.4	64.1	64.5	64.9
80		62.3	64.2	66.1	67.9	69.8	71.7	73.6	75.5	76.4	77.4	78.1	78.5	78.9
100		82.3	84.2	86.1	87.9	89.8	91.7	93.6	95.5	96.4	97.4	98.1	98.5	98.9
125		107.3	109.2	111.1	112.9	114.8	116.7	118.6	120.5	121.4	122.4	123.1	123.5	123.9
		0.00	0.20	0.40	0.60	0.80	1.00	1.20	1.40	1.50	1.60	1.70	1.80	1.90
		-	2.20	2.00	1.80	1.60	1.40	1.20	1.10	1.00	0.90	0.80	0.70	0.60

(inch)												
DCX		3	5	10	15	20	30	40	50	60	80	100
1.500		.027	.034	.049	.060	.069	.084	.097	.109	.119	.137	.154
2.000		.031	.040	.056	.069	.079	.097	.112	.125	.137	.159	.177
2.500		.034	.044	.063	.077	.089	.109	.125	.140	.154	.177	.198
3.000		.038	.049	.069	.084	.097	.119	.137	.154	.168	.194	.217
4.000		.043	.056	.079	.097	.112	.137	.159	.177	.194	.224	.251
5.000		.049	.063	.089	.109	.125	.154	.177	.198	.217	.251	.281

(mm)												
DCX		3	5	10	15	20	30	40	50	60	80	100
35		0.648	0.837	1.183	1.449	1.673	2.049	2.366	2.646	2.898	3.347	3.742
40		0.693	0.894	1.265	1.549	1.789	2.191	2.530	2.828	3.098	3.578	4.000
42		0.710	0.917	1.296	1.587	1.833	2.245	2.592	2.898	3.175	3.666	4.099
50		0.775	1.000	1.414	1.732	2.000	2.449	2.828	3.162	3.464	4.000	4.472
52		0.790	1.020	1.442	1.766	2.040	2.498	2.884	3.225	3.533	4.079	4.561
63		0.869	1.122	1.587	1.944	2.245	2.750	3.175	3.550	3.888	4.490	5.020
66		0.890	1.149	1.625	1.990	2.298	2.814	3.250	3.633	3.980	4.596	5.138
80		0.980	1.265	1.789	2.191	2.530	3.098	3.578	4.000	4.382	5.060	5.657
100		1.095	1.414	2.000	2.449	2.828	3.464	4.000	4.472	4.899	5.657	6.325
125		1.225	1.581	2.236	2.739	3.162	3.873	4.472	5.000	5.477	6.325	7.071



E559

ECONOMICAL HAND AND SERIAL TAPS

INTRODUCTION



Introducing the Dormer E559 series, a fresh line of cost-effective hand and serial taps. The reliable tapping design ensures a smooth cutting action and efficient chip evacuation. Our extensive selection includes the most popular M, MF, UNC and UNF thread forms, available in a wide range of sizes. The Dormer E559 is the right economical choice for maintenance mechanics, field service engineers, craftspeople, contract engineers, and educational institutions.



EXPLANATION HAND TAPS

- + Hand taps cut always a full thread profile
- + Any tap lead can be used for tapping in through holes
- Limitations on usable thread lengths in blind holes



E559N01

- Taper lead



E599N02

- Plug lead



E559N03

- Bottoming lead (Finishing tap)



HAND TAPS OVERVIEW

Straight Flute Taper Lead Hand Tap, ISO Standard

Versatile tap design for hand use or machine tapping in medium strength, medium carbon and alloy steel. With a taper lead chamfer which produces the thinnest chips providing a very gradual and smooth cutting action. Considered to be the best choice for producing short through holes up to 1.5xD.

E559NO1(M)

- Metric range: M3 – M20

E559NO1(MF)

- Metric-fine range: M8x1 – M16x1.5

E559NO1(UNC)

- UNC range: No. 10-24 – 1/2"

E559NO1(UNF)

- UNF range: No. 10-32 – 1/2"-20

Straight Flute Plug Lead Hand Tap, ISO Standard

Versatile tap design for hand use or machine tapping in medium strength, medium carbon and alloy steel. With a plug lead chamfer which gives the tap a gradual cutting action. Great for producing through holes, as they are almost as easy as taper lead taps to start, yet also offer a more complete set of threads.

E559NO2(M)

- Metric range: M3 – M20

E559NO2(MF)

- Metric-fine range: M8x1 – M16x1.5

E559NO2(UNC)

- UNC range: No. 10-24 – 1/2"

E559NO2(UNF)

- UNF range: No. 10-32 – 1/2"-20

Straight Flute Bottoming Lead Hand Tap, ISO Standard

Versatile tap for medium strength carbon and alloy steel. With bottoming lead, which though it is hard to start threading with is capable of cutting thread almost all of the way to the bottom of a blind hole. Best used as machine tap or if by hand in sequence after taper and plug lead or starter and intermediate serial tap.

E559NO3(M)

- Metric range: M3 – M20

E559-NO3(MF)

- Metric-fine range: M8x1 – M16x1.5

E559-NO3(UNC)

- UNC range: No. 10-24 – 1/2"

E559-NO3(UNF)

- UNF range: No. 10-32 – 1/2"-20

Set of 3 Straight Flute Hand Taps, ISO Standard

The most versatile taps for hand use or machine tapping through or blind holes in medium strength, medium carbon and alloy steel. Set including taps with 3 different chamfer lengths; taper lead which is ideally for short through holes, plug perfect for deeper through holes and bottoming best suited for blind holes.

E559NO6(M)

- Metric range: M3 – M20

E559NO6(MF)

- Metric-fine range: M8x1 – M16x1.5

E559NO6(UNC)

- UNC range: No. 10-24 – 1/2"

E559NO6(UNF)

- UNF range: No. 10-32 – 1/2"-20



E559

ECONOMICAL HAND AND SERIAL TAPS

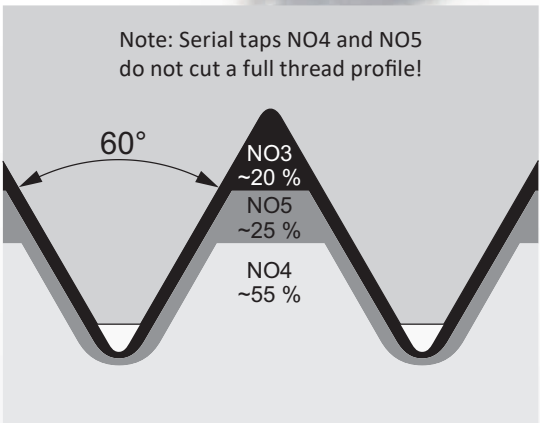

EXPLANATION SERIAL TAPS

- + This set of serial taps requires lower cutting force, ideal to use with wrench.
- + This set of serial taps can be a problem solver for harder materials tapping.
- Serial taps always need to be used in sequence from NO4 to NO3.

E559NO4

- Starter tap

E559NO5

- Seconding tap

E559NO3

- Finishing tap (Bottoming lead)



SERIAL TAPS OVERVIEW

Set of 3 Straight Flute Serial Hand Taps, ISO Standard

Ideal for hand tapping tough materials. The straight flute design makes it suitable for both through and blind holes. Set of 3 taps to be used in sequence, first the starter tap to make a roughing cut, second the intermediate to cut the thread a little fuller and third the finisher for smoothing the thread and making it exact.



E559NO8(M)

- Metric range: M3 – M20



E559NO8(UNC)

- UNC range:
No. 10-24 – 1/2"-8

Set of 2 Straight Flute Serial Hand Taps, ISO Standard

Ideal for hand tapping tough materials. The straight flute design makes it suitable for both through and blind holes. Set of 2 taps to be used in sequence, first the starter tap to make a roughing cut and a finisher for smoothing the thread and making it exact.



E559NO9(MF)

- Metric Fine range:
M8x1 – M16x1.5



E559NO9(UNF)

- UNF range:
No. 10-32 – 1/2"-20



TOOL BITS

HSS-E TOOL BITS

INTRODUCTION



Presenting comprehensive range of Dormer turning tool bits. Made from T2000S HSS-E bright steel with a 10% Cobalt content, ground in accordance with DIN 4964 standards. These tools achieve a robust hardness level of 65 – 67 HRC, ensuring precise and reliable turning performance.





F



- HSS-E
- Rectangular Tool bit
- Metric range:
8 × 6 – 30 × 20 mm



R





- HSS-E
- Round Tool bit
- Metric range:
D3 – D20 mm





S



- HSS-E
- Square Tool bit
- Metric range:
4 × 4 – 25 × 25 mm

SA



- HSS-E
- Square Tool bit with Bevel
- Imperial range:
3/16 × 3/16 – 5/8 × 5/8"
- Metric range:
4 × 4 – 25 × 25 mm



TOOL BITS F

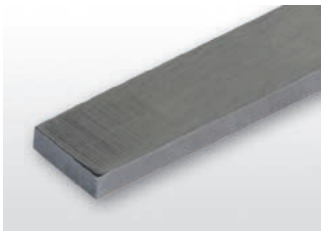

HSS-E Rectangular Tool bit

Ground rectangular tool bit according to DIN 4964 D standard. T2000S HSS-E bright steel with 10% Cobalt content in hardness 65 – 67 HRC.



HSS-E	DIN 4964D	Bright
h13		

Product	H (mm)	B (mm)	OAL (mm)
8X6X200:T2000S	8	6	200.0
10X2X200:T2000S	10	2	200.0
10X3X200:T2000S	10	3	200.0
10X4X200:T2000S	10	4	200.0
10X5X200:T2000S	10	5	200.0
10X6X200:T2000S	10	6	200.0
10X8X200:T2000S	10	8	200.0
12X3X200:T2000S	12	3	200.0
12X4X200:T2000S	12	4	200.0
12X6X200:T2000S	12	6	200.0
12X8X200:T2000S	12	8	200.0
15X3X200:T2000S	15	3	200.0
15X4X200:T2000S	15	4	200.0
15X5X200:T2000S	15	5	200.0
15X6X200:T2000S	15	6	200.0
15X8X200:T2000S	15	8	200.0
15X10X200:T2000S	15	10	200.0
16X8X200:T2000S	16	8	200.0
16X10X200:T2000S	16	10	200.0

Product	H (mm)	B (mm)	OAL (mm)
16X12X200:T2000S	16	12	200.0
20X3X200:T2000S	20	3	200.0
20X4X200:T2000S	20	4	200.0
20X5X200:T2000S	20	5	200.0
20X6X200:T2000S	20	6	200.0
20X8X200:T2000S	20	8	200.0
20X10X200:T2000S	20	10	200.0
20X12X200:T2000S	20	12	200.0
20X15X200:T2000S	20	15	200.0
25X5X200:T2000S	25	5	200.0
25X6X200:T2000S	25	6	200.0
25X10X200:T2000S	25	10	200.0
25X12X200:T2000S	25	12	200.0
30X4X200:T2000S	30	4	200.0
30X5X200:T2000S	30	5	200.0
30X10X200:T2000S	30	10	200.0
30X15X200:T2000S	30	15	200.0
30X20X200:T2000S	30	20	200.0



TOOL BITS R



HSS-E Round Tool bit

Ground round tool bit according to DIN 4964 A standard. T2000S HSS-E bright steel with 10% Cobalt content in hardness 65 – 67 HRC.

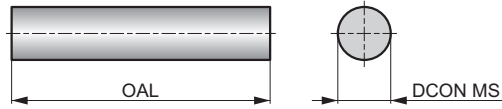

HSS-E	DIN 4964A	Bright
h9		

Product	DCON MS	OAL
	(mm)	(mm)
3X200 T:T2000S	3.00	200.0
4X200 T:T2000S	4.00	200.0
5X200 T:T2000S	5.00	200.0
6X200 T:T2000S	6.00	200.0
7X200 T:T2000S	7.00	200.0
8X200 T:T2000S	8.00	200.0
10X200 T:T2000S	10.00	200.0
12X200 T:T2000S	12.00	200.0
14X200 T:T2000S	14.00	200.0
16X200 T:T2000S	16.00	200.0
20X200 T:T2000S	20.00	200.0



TOOL BITS S

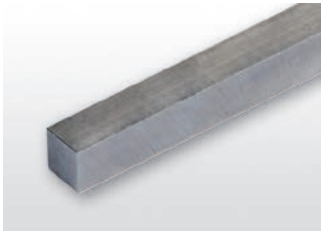

HSS-E Square Tool bit

Ground square tool bit according to DIN 4964 B standard. T2000S HSS-E bright steel with 10% Cobalt content in hardness 65 – 67 HRC.



HSS-E	DIN 4964B	Bright
+0 -0.1		

Product	H (mm)	B (mm)	OAL (mm)
4X4X200:T2000S	4	4	200.0
6X6X200:T2000S	6	6	200.0
8X8X200:T2000S	8	8	200.0
10X10X200:T2000S	10	10	200.0
12X12X200:T2000S	12	12	200.0
14X14X200:T2000S	14	14	200.0
15X15X200:T2000S	15	15	200.0
16X16X200:T2000S	16	16	200.0
20X20X200:T2000S	20	20	200.0
25X25X200:T2000S	25	25	200.0



TOOL BITS SA

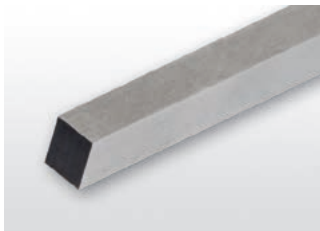

HSS-E Square Tool bit with Bevel

Ground square tool bit with beveled ends according to DIN 4964 B standard. T2000S HSS-E bright steel with 10% Cobalt content in hardness 65 – 67 HRC.

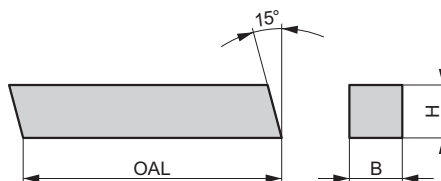

HSS-E	DIN 4964B	Bright
h13		

Product	H	B	OAL	H	B	OAL
	(mm)	(mm)	(mm)	(inch)	(inch)	(inch)
4X4X200A:T2000S	4	4	200.0	—	—	—
6X6X100A:T2000S	6	6	100.0	—	—	—
6X6X200A:T2000S	6	6	200.0	—	—	—
8X8X100A:T2000S	8	8	100.0	—	—	—
8X8X160A:T2000S	8	8	160.0	—	—	—
8X8X200A:T2000S	8	8	200.0	—	—	—
10X10X100A:T2000S	10	10	100.0	—	—	—
10X10X160A:T2000S	10	10	160.0	—	—	—
10X10X200A:T2000S	10	10	200.0	—	—	—
12X12X100A:T2000S	12	12	100.0	—	—	—
12X12X200A:T2000S	12	12	200.0	—	—	—
14X14X200A:T2000S	14	14	200.0	—	—	—
15X15X200A:T2000S	15	15	200.0	—	—	—
16X16X200A:T2000S	16	16	200.0	—	—	—
20X20X200A:T2000S	20	20	200.0	—	—	—
25X25X200A:T2000S	25	25	200.0	—	—	—
3/16X3/16X2.1/2A:T2000S	—	—	—	3/16	3/16	2.500
1/4X1/4X2.1/2A:T2000S	—	—	—	1/4	1/4	2.500
1/4X1/4X4A:T2000S	—	—	—	1/4	1/4	4.000
5/16X5/16X2.1/2A:T2000S	—	—	—	5/16	5/16	2.500
5/16X5/16X4A:T2000S	—	—	—	5/16	5/16	4.000
3/8X3/8X3A:T2000S	—	—	—	3/8	3/8	3.000
3/8X3/8X4A:T2000S	—	—	—	3/8	3/8	4.000
3/8X3/8X6A:T2000S	—	—	—	3/8	3/8	6.000
1/2X1/2X4A:T2000S	—	—	—	1/2	1/2	4.000
1/2X1/2X6A:T2000S	—	—	—	1/2	1/2	6.000
5/8X5/8X6A:T2000S	—	—	—	5/8	5/8	6.000



TECHNICAL INFORMATION



CORRECTION FACTORS – TURNING

Correction factors for specific type of operation C_{VcO}

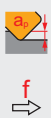
 	FF			F			M			R			HR		
	0.5			1.5			2.5			5.0			12.0		
	I	II	III	I	II	III	I	II	III	I	II	III	I	II	III
	0.05	0.08	0.10	0.10	0.15	0.20	0.20	0.30	0.40	0.40	0.60	0.80	0.80	1.00	1.30
Chip-breakers for fine finishing (FF, FF2...)	1.15	1.00	0.95	0.85	0.80	–	–	–	–	–	–	–	–	–	–
Chip-breakers for finishing (NF, SF...)	–	–	1.20	1.05	1.00	1.05	1.00	0.90	–	–	–	–	–	–	–
Chip-breakers for medium machining (FM, M, NM, NMR, SM...)	–	–	–	–	–	1.15	1.10	1.00	0.95	0.85	–	–	–	–	–
Chip-breakers for roughing (RM, NRM, NR, R...)	–	–	–	–	–	–	–	–	1.25	1.10	1.00	0.95	0.65	–	–
Chip-breakers for heavy roughing (HR, HR2, NR2, OR...) for 45 min durability	–	–	–	–	–	–	–	–	–	1.25	1.20	1.15	1.05	1.00	0.95

Correction factors for required durability C_{VcT}

	minutes	10	15	20	30	45	60
	General machining operations (fine finishing up to roughing)		1.13	1.00	0.93	0.84	0.76
Heavy machining operations (heavy roughing)		–	–	–	1.10	1.00	0.93

Additional correction factors C_{VcA}

Machining environment	C_{VcA}
Condition of the work-material (hard skin due to forging or casting)	0.70
Internal turning	0.75
Parting and grooving (radial)	0.88
Face grooving	0.80
Interrupted cut	0.80
Unstable machining conditions	0.85
Common machining conditions	1.00
Stable machining conditions	1.20

Resulting corrected cutting speed v_{cc}

$$v_{cc} = v_c \times k_{VG} \times C_{VcO} \times C_{VcT} \times C_{VcA}$$





v_c – starting speed from catalogue page

k_{VG} – coefficient of used material



CORRECTION FACTORS – INDEXABLE MILLS

Correction factors for specific type of cutter and operation C_{VcO}

			
Face mills with KAPR 45° – 60° and negative inserts (SHN06C, SHN09C, CHN09, ...)	1.15	1.00	0.85
Face mills with KAPR 45° and positive inserts (SOE06Z, SOE09Z, SOD05,...)	1.15	1.00	0.85
Shoulder mills with KAPR 90° (SAD07D, SAD11E, SAD16E, SLN12, SLN16..)	1.10	1.00	0.90
Copy face mills (SRC10 – SRC20, SRD05 – SRD16, ...)	1.10	1.00	0.90
Copy end mills (K2-PPH, K2-SLC, K2-SRC, K3-CXP...)	1.10	1.00	0.90
Disc mills (S90CN(XN), S90SN...)	1.10	1.00	0.90
Shoulder mills with extended flute J(T)-CSD12X, J(T)-SAD11E, J(T)-SAD16E...)	1.25	1.00	0.80
Face mills for heavy duty (FSB22X, SPN13..)	1.30	1.00	0.85
Shoulder mills for heavy duty (FTB27X..)	1.25	1.00	0.85

Correction factors for required durability C_{VcT}

	minutes	15	20	30	45	60	90	120
General machining operations (fine finishing up to roughing)		1.23	1.13	1.00	0.89	0.81	0.72	–
Heavy machining operations (heavy roughing)		–	–	1.23	1.13	1.00	0.89	0.81

Additional correction factors C_{VcA}

Machining environment	C_{VcA}
Condition of the work-material (hard skin due to forging or casting)	0.70
Unstable machining conditions	0.85
Common machining conditions	1.00
Stable machining conditions	1.20

Correction factors for cutting speed when face and shoulder milling with < 100 % radial immersion C_{VcRCT}

$\frac{a_e}{DC}$	5 %	10 %	15 %	20 %	25 %	30 %	40 %	50 %	60 %	70 %	75 %	80 %	90 %	100 %
	1.48	1.35	1.27	1.22	1.19	1.16	1.11	1.08	1.05	1.03	1.00	1.00	1.00	1.00

Resulting corrected cutting speed v_{cc}

$$v_{cc} = v_c \times k_{VG} \times C_{VcO} \times C_{VcT} \times C_{VcA} \times C_{fzRCT}$$

v_c – starting speed from catalogue page

k_{VG} – coefficient of used material

WMG (WORK MATERIAL GROUP)

ISO group	WMG (Work Material Group)	Hardness (HB or HRC)	Ultimate Tensile Strength (MPa)	Correction factor kvG	
P	P1 Free machining steel (carbon steels with increased machinability)	Sulfurized	< 240 HB	≤ 830	1.33
		Sulfurized and phosphorized	< 180 HB	≤ 620	1.49
		Sulfurized/phosphorized and leaded	< 180 HB	≤ 620	1.53
	P2 Plain carbon steel (steels comprised of mainly iron and carbon)	Containing < 0.25 % C	< 180 HB	≤ 620	1.14
		Containing < 0.55 % C	< 240 HB	≤ 830	1.00
		Containing > 0.55 % C	< 300 HB	≤ 1030	0.89
	P3 Alloy steel (carbon steels with an alloying content ≤ 10 %)	Annealed	< 180 HB	≤ 620	0.92
		Hardened and tempered	180 – 260 HB	> 620 ≤ 900	0.74
			260 – 360 HB	> 900 ≤ 1240	0.63
	P4 Tool steel (special alloy steel for tools, dies and molds)	Annealed	< 26 HRC	≤ 900	0.55
Hardened and tempered		26 – 39 HRC	> 900 ≤ 1240	0.47	
		39 – 45 HRC	> 1240 ≤ 1450	0.38	
M	M1 Ferritic stainless steel (straight chromium non-hardenable alloys)	< 160 HB	≤ 520	1.22	
		160 – 220 HB	> 520 ≤ 700	1.03	
	M2 Martensitic stainless steel (straight chromium hardenable alloys)	Annealed	< 200 HB	≤ 670	1.08
		Quenched and tempered	200 – 280 HB	> 670 ≤ 950	0.89
		Precipitation-hardened	280 – 380 HB	> 950 ≤ 1300	0.75
	M3 Austenitic stainless steel (chromium-nickel and chromium-nickel-manganese alloys)	< 200 HB	≤ 750	1.00	
		200 – 260 HB	> 750 ≤ 870	0.86	
		260 – 300 HB	> 870 ≤ 1040	0.77	
	M4 Austenitic-ferritic (DUPLEX) or super-austenitic stainless steel	< 300 HB	≤ 990	0.75	
		M4.2 Precipitation hardening austenitic stainless steel	300 – 380 HB	≤ 1320	0.64
K	K1 Gray iron or Automotive Gray iron (GG) (iron-carbon castings with a lamellar graphite microstructure)	Ferritic or ferritic-pearlitic	< 180 HB	≤ 190	1.35
		Ferritic-pearlitic or pearlitic	180 – 240 HB	> 190 ≤ 310	1.00
		Pearlitic	240 – 280 HB	> 310 ≤ 390	0.75
	K2 Malleable iron (GTS/GTW) (iron-carbon castings with a graphite-free microstructure)	Ferritic	< 160 HB	≤ 400	1.39
		Ferritic or pearlitic	160 – 200 HB	> 400 ≤ 550	1.13
		Pearlitic	200 – 240 HB	> 550 ≤ 660	0.90
	K3 Ductile iron (GGG) (iron-carbon castings with a nodular graphite microstructure)	Ferritic	< 180 HB	≤ 560	1.23
		Ferritic or pearlitic	180 – 220 HB	> 560 ≤ 680	0.94
		Pearlitic	220 – 260 HB	> 680 ≤ 800	0.76
	K4 Austenitic gray iron (ASTM A436) (iron-carbon alloy castings with an austenitic lamellar graphite microstructure)	< 180 HB	≤ 190	1.14	
		Austenitic ductile iron (ASTM A439 or ASTM A571) (iron-carbon alloy castings with an austenitic nodular graphite microstructure)	< 240 HB	≤ 740	0.86
			< 280 HB	> 840 ≤ 980	0.63
			280 – 320 HB	> 980 ≤ 1130	0.54
			320 – 360 HB	> 1130 ≤ 1280	0.45
	K5 Compacted graphite iron CGI (ASTM A842) (iron-carbon castings with a vermicular graphite structure)	Ferritic	< 180 HB	≤ 400	1.29
Ferritic-pearlitic		180 – 220 HB	> 400 ≤ 450	0.97	
Pearlitic		220 – 260 HB	> 450 ≤ 500	0.75	
N	N1 Commercially pure wrought aluminium	< 60 HB	≤ 240	1.33	
		Wrought aluminium alloys	60 – 100 HB	> 240 ≤ 400	1.00
			100 – 150 HB	> 400 ≤ 590	0.67
	N2 Cast aluminium alloys	< 75 HB	≤ 240	0.67	
		75 – 90 HB	> 240 ≤ 270	0.60	
		90 – 140 HB	> 270 ≤ 440	0.43	
	N3 Free-cutting copper-alloys materials with excellent machining properties	–	–	0.70	
		Short-chip copper-alloys with good to moderate machining properties	–	–	0.41
		Electrolytic copper and long-chip copper-alloys with moderate to poor machining properties	–	–	0.21
	N4 Thermoplastic polymers	–	–	0.70	
Thermosetting polymers		–	–	0.27	
Reinforced polymers or composites		–	–	0.29	
N5 Graphite	–	–	1.00		
S	S1 Titanium or titanium alloys	< 200 HB	≤ 660	1.94	
		200 – 280 HB	> 660 ≤ 950	1.72	
		280 – 360 HB	> 950 ≤ 1200	1.44	
	S2 Fe-based high-temperature alloys	< 200 HB	≤ 690	1.33	
		200 – 280 HB	> 690 ≤ 970	1.17	
	S3 Ni-based high-temperature alloys	< 280 HB	≤ 940	1.00	
		280 – 360 HB	> 940 ≤ 1200	0.83	
	S4 Co-based high-temperature alloys	< 240 HB	≤ 800	0.78	
240 – 320 HB		> 800 ≤ 1070	0.67		
H	H1 Chilled cast iron	< 440 HB	–	1.52	
		< 55 HRC	–	0.90	
	H2 Hardened cast iron	> 55 HRC	–	0.77	
		< 51 HRC	–	1.00	
	H3 Hardened steel < 55 HRC	51 – 55 HRC	–	0.82	
		55 – 59 HRC	–	0.64	
	H4 Hardened steel > 55 HRC	> 59 HRC	–	0.54	

SIMPLY RELIABLE

As a professional you can judge the quality of work by just looking at the chip. Our chip is a clean and uncomplicated shape that in itself tells a story. It is a clear and consistent signal and that's why we use it as a symbol for being **Simply Reliable**.

DORMER PRAMET

www.dormerpramet.com



**CONTACTS TO LOCAL
SALES SUPPORT
ALWAYS UP TO DATE!**



DP-BRO-NEWS-2024-US

FOLLOW US...



ONLINE



SEGMENTS



LIBRARY APP.



CALCULATOR APP.