

DORMER PRAMET

NEW PRODUCTS

2024



 DORMER

 PRAMET



NEW PRODUCTS 2024 – CONTENT

2	R003 R023	VERSATILE SOLID CARBIDE DRILLS WITH TIN TIP
10	E397 E398	HIGHLY PRODUCTIVE MULTI APPLICATION TAPS (DIN)
22	T8415	VERSATILE PVD TURNING GRADE
56	SSO12	VERSATILE HIGH FEED MILLING
64	E559	ECONOMICAL HAND AND SERIAL TAPS
68	A113	BRIGHT HSS DRILL
73		HSS-E TOOL BITS
79		TECHNICAL INFORMATION



R003
R023

VERSATILE SOLID CARBIDE DRILLS WITH TIN TIP

INTRODUCTION



Introducing Dormer R003 and R023 – new general purpose, versatile solid carbide jobber and stub drills with a TiN tip coating. New design features result in excellent tool life, low cost per hole and high tool life consistency. The Dormer R003 and R023 also offer low thrust force making them versatile for both CNC and conventional machines operations.



R003



- Solid carbide jobber drill
- Versatile, cost-effective
- Metric range: 1 – 14 mm
- Imperial range: N60 – 1/2"



R023



- Solid carbide stub drill
- Versatile, cost-effective
- Metric range: 1 – 12 mm



FEATURES AND BENEFITS

Specifically designed four facet split point provides excellent self-centering.



REDUCED THRUST FORCE

eases the operation whilst maintaining precision.

Titanium Nitride (TiN) tip coating on only the cutting action part of the drill.



EXTENDED AND CONSISTENT TOOL LIFE

provides cost-effective reliability.

CTW grinding technology provides Continuously Thinned Web along the entire flute length.



MULTIPLE REGRINDING POSSIBLE

without loss of chip evacuation performance.

Balanced combination of flute geometry and 120° point angle for broader application range.



VERSATILE USAGE

on both CNC and conventional machines.

Optimized point geometry with four facet split point

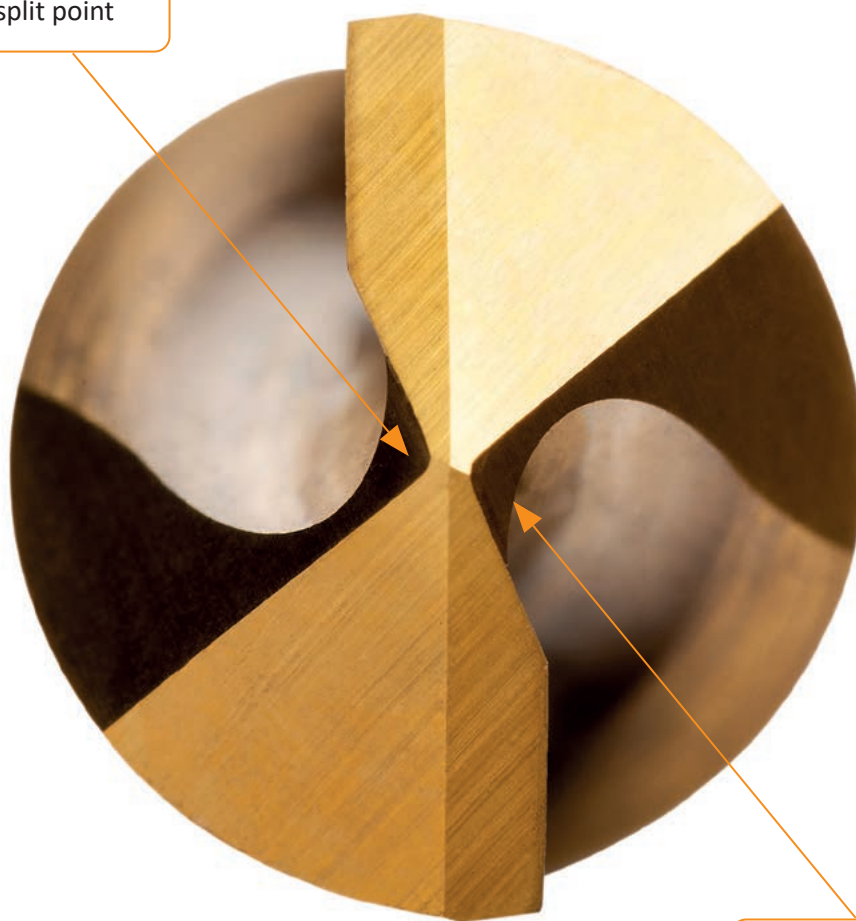

CTW
(Continuously thinned web)



R003
R023

VERSATILE SOLID CARBIDE DRILLS WITH TIN TIP

SUCCESS STORIES – R003 & R023

Segment: Power generation industry (Mexico)
Component: Assembly for electrical harnesses
Material: SAE 4140 / 1.7225 / 42CrMo4 (alloy steel, 190 HB)
Coolant: Yes, external, synthetic emulsion
Application: Haas CNC machine drilling with pecking, through holes
Previous results: Currently best competing drill has a high-end coating and a double margin, described to be a high performance drill.

Result with R003: Customer noticed lower thrust force when compared to other competing tools. R003 also provides comparable tool life and good hole finish, simply better cost effectiveness!

Dormer Pramet solution:

R0031/4

Machining data:

v_c	f_n	a_p
54	0.2	12.7

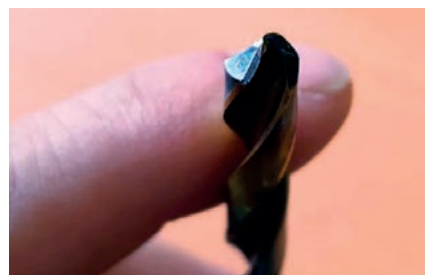

WMG P3.2

Segment: Agriculture machinery sub-contractor (India)
Component: Cast iron flywheel for tractor
Material: FG260 / GG25 (180 – 220 HB)
Coolant: Dry, no coolant
Application: Vertical CNC drilling, through holes without pecking
Previous results: Competitor drill had abnormal wear, usually after 260 holes the drill couldn't be used any further, or sometimes prematurely broke.

Result with R003: Dormer with TiN tip had better tool life compared to all competitors, finishing tests without breaking or with excessive wear after 264 holes, while using the same cutting parameters!

Dormer Pramet solution:

R0036.8

Machining data:

v_c	f_n	a_p
25.6	0.126	30

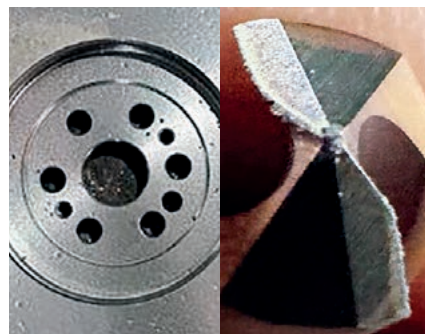

WMG K1.2

Segment: Powder metal parts producer (Canada)
Component: Fixture plates
Material: SAE 4340 / 1.6582 / 34CrNiMo6 (quenched alloy steel, 53 HRC)
Coolant: Yes, external, water soluble oil emulsion (8%)
Application: Manually driven pillar drill machine, Locating dowel holes
Previous results: Competing drill needs lot of manual pressure to penetrate through the hardened material, it took 30 seconds to make the hole. The drill is worn out after 1 hole.

Result with R003: Dormer drill is able to penetrate the material in just 12 seconds with radically lower drilling effort, and it's still in good shape to continue on another hole.

Dormer Pramet solution:

R0031/4

Machining data:

v_c	f_n	a_p
29	0.08	7.6



WMG H3.1



DRILLING TOOLS

Segment: Hydraulic pumps parts sub-contractor (Italy)
Component: Hydraulic flow control valve
Material: 11SMnPb37 / 1.0737 (Free machining steel, 145 HB)
Coolant: Yes, external, water soluble oil emulsion (8%)
Application: Bridgeport CNC drilling before M8 thread, 35 mm deep with pecking
Previous results: Competing premium drill has setup according to manufacturer's recommendation ($v_c = 64$ m/min, $f_n = 0.25$ mm/rev), but tool life of 2300 holes is not satisfactory.

Result with R003: Our drill outperforms competing premium drill by slightly better tool life and also productivity, proves to be the best cost-effective choice for the job!

Dormer Pramet solution:
R0036.8

Machining data:		
v_c	f_n	a_p
96	0.2	35

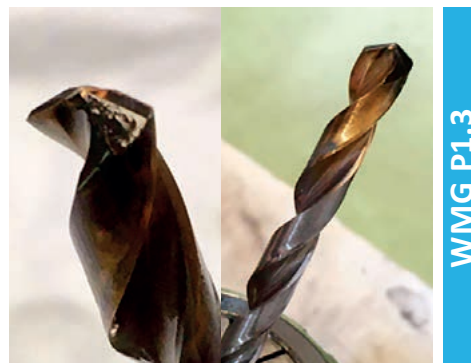

WMG P1.3

Segment: Machinery parts sub-contractor (China)
Component: Gearbox casing
Material: C45 / 1.0503 (Carbon steel, 225 HB)
Coolant: Yes, external, water soluble oil emulsion (8%)
Application: Vertical CNC drilling, through holes
Previous results: Long-term tests running to evaluate precisely cost per hole on most common job – steel case drilling.

Result with R003: Our drill with TiN tip achieved +15% longer tool life than similar competitor drill and a number of holes very close to a premium competitor drill.

Dormer Pramet solution:
R0032.5

Machining data:		
v_c	f_n	a_p
90	0.05	4



WMG P2.1

Segment: General engineering, Automotive parts sub-contractor (Italy)
Component: Splined shaft coupling
Material: 11SMnPb37 / 1.0737 (Free machining steel, 145 HB)
Coolant: Yes, external, water soluble oil emulsion (8%)
Application: Doosan CNC lathe pre-drilling for M3 thread, 12 mm deep with pecking
Previous results: Competing uncoated carbide drill had stable tool life set on 1400 workpieces with $v_c = 27$ m/min. It was difficult to regrind the drill afterwards as it was almost destroyed.

Result with R003: Our TiN tip coated drill finished whole batch of 2000 workpieces with no visible wear with even higher cutting speed, improving productivity by 48%.

Dormer Pramet solution:
R0032.8

Machining data:		
v_c	f_n	a_p
40	0.08	12

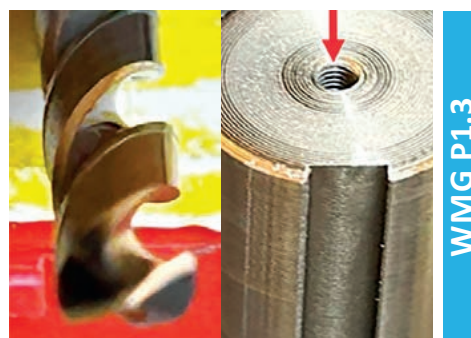

WMG P1.3



R003



Solid Carbide Jobber Drill, TiN tip Coated

Versatile entry-level drill with 120° point angle with four facet split point geometry for reduced thrust force and CTW flute construction for enhanced penetration rates. TiN tip coating improves performance and extends tool life. Suitable for both CNC machines and conventional machines across a wide range of workpiece materials.

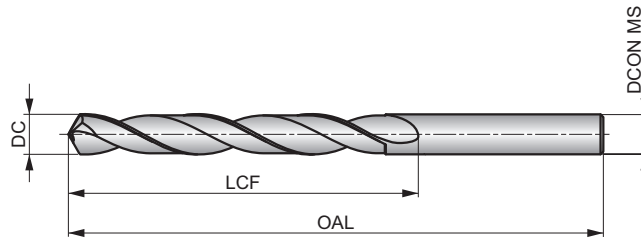

HM	DIN 338	4xD
120°	TiN-Tip	
λ 20-35°	R	DC h7

Workpiece material group suitability, starting values for cutting speed (m/min) and feed Alpha Code. Tables with feed per revolution can be found starting from page 10.

P1.1 ■ 99 S	P1.2 ■ 111 S	P1.3 ■ 115 S	P2.1 ■ 85 S	P2.2 ■ 75 S	P2.3 ■ 66 S	P3.1 ■ 66 S	P3.2 ■ 53 S	P3.3 ■ 45 S	P4.1 ■ 40 S	P4.2 ■ 34 S	P4.3 ■ 27 S	K1.1 ■ 75 T	K1.2 ■ 56 T
K1.3 ■ 42 T	K2.1 ■ 68 T	K2.2 ■ 55 T	K2.3 ■ 44 T	K3.1 ■ 60 T	K3.2 ■ 46 T	K3.3 ■ 37 T	K4.1 ■ 55 T	K4.2 ■ 42 T	K4.3 ■ 31 T	K4.4 ■ 26 T	K4.5 ■ 22 T	K5.1 ■ 63 T	K5.2 ■ 47 T
K5.3 ■ 37 T	N1.1 ■ 150 V	N1.2 ■ 113 V	N1.3 ■ 75 V	N2.1 ■ 129 V	N2.2 ■ 116 V	N2.3 ■ 84 V	N3.1 ■ 317 V	N3.2 ■ 190 V	N4.1 ■ 60 U	N4.2 ■ 100 U	H1.1 ■ 34 S	H2.1 ■ 20 S	H3.1 ■ 22 S

Product	DC (inch)	DC (mm)	DC (inch)	LCF (mm)	OAL (mm)	DCON MS (mm)
R0031.0	-	1.00	0.0394	12.0	34.0	1.00
R003N60	N60	1.02	0.0400	12.0	34.0	1.02
R0031.1	-	1.10	0.0433	14.0	36.0	1.10
R003N56	N56	1.18	0.0465	16.0	38.0	1.18
R0033/64	3/64	1.19	0.0469	16.0	38.0	1.19
R0031.2	-	1.20	0.0472	16.0	38.0	1.20
R0031.3	-	1.30	0.0512	16.0	38.0	1.30
R003N54	N54	1.40	0.0550	18.0	40.0	1.40
R0031.4	-	1.40	0.0551	18.0	40.0	1.40
R0031.5	-	1.50	0.0591	18.0	40.0	1.50
R003N53	N53	1.51	0.0595	20.0	43.0	1.51
R0031/16	1/16	1.59	0.0625	20.0	43.0	1.59
R0031.6	-	1.60	0.0630	20.0	43.0	1.60
R003N52	N52	1.61	0.0635	20.0	43.0	1.61
R0031.7	-	1.70	0.0669	20.0	43.0	1.70
R003N51	N51	1.70	0.0670	22.0	46.0	1.70
R003N50	N50	1.78	0.0700	22.0	46.0	1.78
R0031.8	-	1.80	0.0709	22.0	46.0	1.80
R0031.9	-	1.90	0.0748	22.0	46.0	1.90
R003N48	N48	1.93	0.0760	24.0	49.0	1.93
R0035/64	5/64	1.98	0.0781	24.0	49.0	1.98
R003N47	N47	1.99	0.0785	24.0	49.0	1.99
R0032.0	-	2.00	0.0787	24.0	49.0	2.00
R003N46	N46	2.06	0.0810	24.0	49.0	2.06
R0032.1	-	2.10	0.0827	24.0	49.0	2.10
R003N44	N44	2.18	0.0860	27.0	53.0	2.18
R0032.2	-	2.20	0.0866	27.0	53.0	2.20
R003N43	N43	2.26	0.0890	27.0	53.0	2.26

Product	DC (inch)	DC (mm)	DC (inch)	LCF (mm)	OAL (mm)	DCON MS (mm)
R0032.3	-	2.30	0.0906	27.0	53.0	2.30
R0033/32	3/32	2.38	0.0937	30.0	57.0	2.38
R0032.4	-	2.40	0.0945	30.0	57.0	2.40
R003N41	N41	2.44	0.0960	30.0	57.0	2.44
R0032.5	-	2.50	0.0984	30.0	57.0	2.50
R003N39	N39	2.53	0.0995	30.0	57.0	2.53
R003N38	N38	2.58	0.1015	30.0	57.0	2.58
R0032.6	-	2.60	0.1024	30.0	57.0	2.60
R003N37	N37	2.64	0.1040	30.0	57.0	2.64
R0032.7	-	2.70	0.1063	33.0	61.0	2.70
R003N36	N36	2.71	0.1065	33.0	61.0	2.71
R0037/64	7/64	2.78	0.1094	33.0	61.0	2.78
R0032.8	-	2.80	0.1102	33.0	61.0	2.80
R003N33	N33	2.87	0.1130	33.0	61.0	2.87
R0032.9	-	2.90	0.1142	33.0	61.0	2.90
R003N32	N32	2.95	0.1160	33.0	61.0	2.95
R0033.0	-	3.00	0.1181	33.0	61.0	3.00
R003N31	N31	3.05	0.1200	36.0	65.0	3.05
R0033.1	-	3.10	0.1220	36.0	65.0	3.10
R0031/8	1/8	3.17	0.1250	36.0	65.0	3.17
R0033.2	-	3.20	0.1260	36.0	65.0	3.20
R0033.3	-	3.30	0.1299	36.0	65.0	3.30
R0033.4	-	3.40	0.1339	39.0	70.0	3.40
R003N29	N29	3.45	0.1360	39.0	70.0	3.45
R0033.5	-	3.50	0.1378	39.0	70.0	3.50
R003N28	N28	3.57	0.1405	39.0	70.0	3.57
R0039/64	9/64	3.57	0.1406	39.0	70.0	3.57
R0033.6	-	3.60	0.1417	39.0	70.0	3.60



Product	DC	DC	DC	LCF	OAL	D CON MS
	(inch)	(mm)	(inch)	(mm)	(mm)	(mm)
R0033.7	–	3.70	0.1457	39.0	70.0	3.70
R003N26	N26	3.73	0.1470	39.0	70.0	3.73
R003N25	N25	3.80	0.1495	43.0	75.0	3.80
R0033.8	–	3.80	0.1496	43.0	75.0	3.80
R0033.9	–	3.90	0.1535	43.0	75.0	3.90
R0035/32	5/32	3.97	0.1563	43.0	75.0	3.97
R0034.0	–	4.00	0.1575	43.0	75.0	4.00
R003N21	N21	4.04	0.1590	43.0	75.0	4.04
R003N20	N20	4.09	0.1610	43.0	75.0	4.09
R0034.1	–	4.10	0.1614	43.0	75.0	4.10
R0034.2	–	4.20	0.1654	43.0	75.0	4.20
R003N19	N19	4.22	0.1660	43.0	75.0	4.22
R0034.3	–	4.30	0.1693	47.0	80.0	4.30
R00311/64	11/64	4.37	0.1719	47.0	80.0	4.37
R003N17	N17	4.39	0.1730	47.0	80.0	4.39
R0034.4	–	4.40	0.1732	47.0	80.0	4.40
R0034.5	–	4.50	0.1772	47.0	80.0	4.50
R003N15	N15	4.57	0.1800	47.0	80.0	4.57
R0034.6	–	4.60	0.1811	47.0	80.0	4.60
R0034.7	–	4.70	0.1850	47.0	80.0	4.70
R0033/16	3/16	4.76	0.1875	52.0	86.0	4.76
R003N12	N12	4.80	0.1890	52.0	86.0	4.80
R0034.8	–	4.80	0.1890	52.0	86.0	4.80
R003N11	N11	4.85	0.1910	52.0	86.0	4.85
R0034.9	–	4.90	0.1929	52.0	86.0	4.90
R003N10	N10	4.92	0.1935	52.0	86.0	4.92
R0035.0	–	5.00	0.1969	52.0	86.0	5.00
R0035.1	–	5.10	0.2008	52.0	86.0	5.10
R003N7	N7	5.11	0.2010	52.0	86.0	5.11
R00313/64	13/64	5.16	0.2031	52.0	86.0	5.16
R0035.2	–	5.20	0.2047	52.0	86.0	5.20
R0035.3	–	5.30	0.2087	52.0	86.0	5.30
R0035.4	–	5.40	0.2126	57.0	93.0	5.40
R003N3	N3	5.41	0.2130	57.0	93.0	5.41
R0035.5	–	5.50	0.2165	57.0	93.0	5.50
R0037/32	7/32	5.56	0.2187	57.0	93.0	5.56
R0035.6	–	5.60	0.2205	57.0	93.0	5.60
R003N2	N2	5.61	0.2210	57.0	93.0	5.61
R0035.7	–	5.70	0.2244	57.0	93.0	5.70
R0035.8	–	5.80	0.2283	57.0	93.0	5.80
R0035.9	–	5.90	0.2323	57.0	93.0	5.90
R00315/64	15/64	5.95	0.2344	57.0	93.0	5.95
R0036.0	–	6.00	0.2362	57.0	93.0	6.00
R0036.1	–	6.10	0.2402	63.0	101.0	6.10
R003C	C	6.15	0.2420	63.0	101.0	6.15
R0036.2	–	6.20	0.2441	63.0	101.0	6.20
R0036.3	–	6.30	0.2480	63.0	101.0	6.30
R0031/4	1/4	6.35	0.2500	63.0	101.0	6.35
R0036.4	–	6.40	0.2520	63.0	101.0	6.40
R0036.5	–	6.50	0.2559	63.0	101.0	6.50
R003F	F	6.53	0.2570	63.0	101.0	6.53
R0036.6	–	6.60	0.2598	63.0	101.0	6.60
R0036.7	–	6.70	0.2638	63.0	101.0	6.70
R00317/64	17/64	6.75	0.2656	69.0	109.0	6.75
R0036.8	–	6.80	0.2677	69.0	109.0	6.80
R0036.9	–	6.90	0.2717	69.0	109.0	6.90

Product	DC	DC	DC	LCF	OAL	D CON MS
	(inch)	(mm)	(inch)	(mm)	(mm)	(mm)
R003I	I	6.91	0.2720	69.0	109.0	6.91
R0037.0	–	7.00	0.2756	69.0	109.0	7.00
R0037.1	–	7.10	0.2795	69.0	109.0	7.10
R0039/32	9/32	7.14	0.2813	69.0	109.0	7.14
R0037.2	–	7.20	0.2835	69.0	109.0	7.20
R0037.3	–	7.30	0.2874	69.0	109.0	7.30
R0037.4	–	7.40	0.2913	69.0	109.0	7.40
R0037.5	–	7.50	0.2953	69.0	109.0	7.50
R00319/64	19/64	7.54	0.2969	75.0	117.0	7.54
R0037.6	–	7.60	0.2992	75.0	117.0	7.60
R0037.7	–	7.70	0.3031	75.0	117.0	7.70
R0037.8	–	7.80	0.3071	75.0	117.0	7.80
R0037.9	–	7.90	0.3110	75.0	117.0	7.90
R0035/16	5/16	7.94	0.3125	75.0	117.0	7.94
R0038.0	–	8.00	0.3150	75.0	117.0	8.00
R0038.1	–	8.10	0.3189	75.0	117.0	8.10
R0038.2	–	8.20	0.3228	75.0	117.0	8.20
R0038.3	–	8.30	0.3268	75.0	117.0	8.30
R00321/64	21/64	8.33	0.3281	75.0	117.0	8.33
R0038.4	–	8.40	0.3307	75.0	117.0	8.40
R003Q	Q	8.43	0.3320	75.0	117.0	8.43
R0038.5	–	8.50	0.3346	75.0	117.0	8.50
R0038.6	–	8.60	0.3386	81.0	125.0	8.60
R003R	R	8.61	0.3390	81.0	125.0	8.61
R0038.7	–	8.70	0.3425	81.0	125.0	8.70
R00311/32	11/32	8.73	0.3437	81.0	125.0	8.73
R0038.8	–	8.80	0.3465	81.0	125.0	8.80
R0038.9	–	8.90	0.3504	81.0	125.0	8.90
R0039.0	–	9.00	0.3543	81.0	125.0	9.00
R0039.1	–	9.10	0.3583	81.0	125.0	9.10
R00323/64	23/64	9.13	0.3594	81.0	125.0	9.13
R0039.2	–	9.20	0.3622	81.0	125.0	9.20
R0039.3	–	9.30	0.3661	81.0	125.0	9.30
R003U	U	9.35	0.3680	81.0	125.0	9.35
R0039.4	–	9.40	0.3701	81.0	125.0	9.40
R0039.5	–	9.50	0.3740	81.0	125.0	9.50
R0033/8	3/8	9.53	0.3750	87.0	133.0	9.53
R0039.6	–	9.60	0.3780	87.0	133.0	9.60
R0039.7	–	9.70	0.3819	87.0	133.0	9.70
R0039.8	–	9.80	0.3858	87.0	133.0	9.80
R003W	W	9.80	0.3860	87.0	133.0	9.80
R0039.9	–	9.90	0.3898	87.0	133.0	9.90
R00310.0	–	10.00	0.3937	87.0	133.0	10.00
R00310.2	–	10.20	0.4016	87.0	133.0	10.20
R00313/32	13/32	10.32	0.4063	87.0	133.0	10.32
R00310.5	–	10.50	0.4134	87.0	133.0	10.50
R00327/64	27/64	10.72	0.4219	94.0	142.0	10.72
R00311.0	–	11.00	0.4331	94.0	142.0	11.00
R0037/16	7/16	11.11	0.4375	94.0	142.0	11.11
R00311.5	–	11.50	0.4528	94.0	142.0	11.50
R00329/64	29/64	11.51	0.4531	94.0	142.0	11.51
R00315/32	15/32	11.91	0.4687	101.0	151.0	11.91
R00312.0	–	12.00	0.4724	101.0	151.0	12.00
R0031/2	1/2	12.70	0.5000	101.0	151.0	12.70
R00313.0	–	13.00	0.5118	101.0	151.0	13.00
R00314.0	–	14.00	0.5512	108.0	160.0	14.00



R023



Solid Carbide Stub Drill, TiN tip Coated

Versatile entry-level drill with 120° point angle with four facet split point geometry for reduced thrust force and CTW flute construction for enhanced penetration rates. TiN tip coating improves performance and extends tool life. Suitable for both CNC machines and conventional machines across a wide range of workpiece materials.

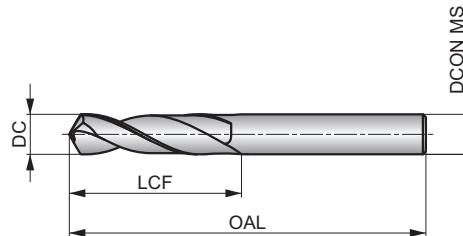

HM	DIN 6539	2.5×D
120°	TiN-Tip	
λ 20-35°	R	DC h7

Workpiece material group suitability, starting values for cutting speed (m/min) and feed Alpha Code. Tables with feed per revolution can be found starting from page 10.

P1.1 ■ 99 T	P1.2 ■ 111 T	P1.3 ■ 115 T	P2.1 ■ 85 T	P2.2 ■ 75 T	P2.3 ■ 66 T	P3.1 ■ 66 T	P3.2 ■ 53 T	P3.3 ■ 45 T	P4.1 ■ 40 S	P4.2 ■ 34 S	P4.3 ■ 27 S	K1.1 ■ 75 U	K1.2 ■ 56 U
K1.3 ■ 42 U	K2.1 ■ 68 U	K2.2 ■ 55 U	K2.3 ■ 44 U	K3.1 ■ 60 U	K3.2 ■ 46 U	K3.3 ■ 37 U	K4.1 ■ 55 T	K4.2 ■ 42 T	K4.3 ■ 31 T	K4.4 ■ 26 T	K4.5 ■ 22 T	K5.1 ■ 63 U	K5.2 ■ 47 U
K5.3 ■ 37 U	N1.1 ■ 150 W	N1.2 ■ 113 W	N1.3 ■ 75 W	N2.1 ■ 129 W	N2.2 ■ 116 W	N2.3 ■ 84 W	N3.1 ■ 317 W	N3.2 ■ 190 W	N4.1 ■ 60 V	N4.2 ■ 100 V	H1.1 ■ 34 S	H2.1 ■ 20 S	H3.1 ■ 22 S

Product	DC	DC	LCF	OAL	DCON MS
	(mm)	(inch)			
R0231.0	1.00	0.0394	6.0	26.0	1.00
R0231.1	1.10	0.0433	7.0	28.0	1.10
R0231.2	1.20	0.0472	8.0	30.0	1.20
R0231.3	1.30	0.0512	8.0	30.0	1.30
R0231.4	1.40	0.0551	9.0	32.0	1.40
R0231.5	1.50	0.0591	9.0	32.0	1.50
R0231.6	1.60	0.0630	10.0	34.0	1.60
R0231.7	1.70	0.0669	10.0	34.0	1.70
R0231.8	1.80	0.0709	11.0	36.0	1.80
R0231.9	1.90	0.0748	11.0	36.0	1.90
R0232.0	2.00	0.0787	12.0	38.0	2.00
R0232.1	2.10	0.0827	12.0	38.0	2.10
R0232.2	2.20	0.0866	13.0	40.0	2.20
R0232.3	2.30	0.0906	13.0	40.0	2.30
R0232.4	2.40	0.0945	14.0	43.0	2.40
R0232.5	2.50	0.0984	14.0	43.0	2.50
R0232.6	2.60	0.1024	14.0	43.0	2.60
R0232.7	2.70	0.1063	16.0	46.0	2.70
R0232.8	2.80	0.1102	16.0	46.0	2.80
R0232.9	2.90	0.1142	16.0	46.0	2.90
R0233.0	3.00	0.1181	16.0	46.0	3.00
R0233.1	3.10	0.1220	18.0	49.0	3.10
R0233.2	3.20	0.1260	18.0	49.0	3.20
R0233.3	3.30	0.1299	18.0	49.0	3.30
R0233.4	3.40	0.1339	20.0	52.0	3.40
R0233.5	3.50	0.1378	20.0	52.0	3.50
R0233.6	3.60	0.1417	20.0	52.0	3.60
R0233.7	3.70	0.1457	20.0	52.0	3.70

Product	DC	DC	LCF	OAL	DCON MS
	(mm)	(inch)			
R0233.8	3.80	0.1496	22.0	55.0	3.80
R0233.9	3.90	0.1535	22.0	55.0	3.90
R0234.0	4.00	0.1575	22.0	55.0	4.00
R0234.1	4.10	0.1614	22.0	55.0	4.10
R0234.2	4.20	0.1654	22.0	55.0	4.20
R0234.3	4.30	0.1693	24.0	58.0	4.30
R0234.4	4.40	0.1732	24.0	58.0	4.40
R0234.5	4.50	0.1772	24.0	58.0	4.50
R0234.6	4.60	0.1811	24.0	58.0	4.60
R0234.7	4.70	0.1850	24.0	58.0	4.70
R0234.8	4.80	0.1890	26.0	62.0	4.80
R0234.9	4.90	0.1929	26.0	62.0	4.90
R0235.0	5.00	0.1969	26.0	62.0	5.00
R0235.1	5.10	0.2008	26.0	62.0	5.10
R0235.2	5.20	0.2047	26.0	62.0	5.20
R0235.3	5.30	0.2087	26.0	62.0	5.30
R0235.4	5.40	0.2126	28.0	66.0	5.40
R0235.5	5.50	0.2165	28.0	66.0	5.50
R0235.6	5.60	0.2205	28.0	66.0	5.60
R0235.7	5.70	0.2244	28.0	66.0	5.70
R0235.8	5.80	0.2283	28.0	66.0	5.80
R0235.9	5.90	0.2323	28.0	66.0	5.90
R0236.0	6.00	0.2362	28.0	66.0	6.00
R0236.1	6.10	0.2402	31.0	70.0	6.10
R0236.2	6.20	0.2441	31.0	70.0	6.20
R0236.3	6.30	0.2480	31.0	70.0	6.30
R0236.4	6.40	0.2520	31.0	70.0	6.40
R0236.5	6.50	0.2559	31.0	70.0	6.50



Product	DC	DC	LCF	OAL	DCON MS
	(mm)	(inch)	(mm)	(mm)	(mm)
R0236.6	6.60	0.2598	31.0	70.0	6.60
R0236.7	6.70	0.2638	31.0	70.0	6.70
R0236.8	6.80	0.2677	34.0	74.0	6.80
R0236.9	6.90	0.2717	34.0	74.0	6.90
R0237.0	7.00	0.2756	34.0	74.0	7.00
R0237.1	7.10	0.2795	34.0	74.0	7.10
R0237.2	7.20	0.2835	34.0	74.0	7.20
R0237.3	7.30	0.2874	34.0	74.0	7.30
R0237.4	7.40	0.2913	34.0	74.0	7.40
R0237.5	7.50	0.2953	34.0	74.0	7.50
R0237.6	7.60	0.2992	37.0	79.0	7.60
R0237.7	7.70	0.3031	37.0	79.0	7.70
R0237.8	7.80	0.3071	37.0	79.0	7.80
R0237.9	7.90	0.3110	37.0	79.0	7.90
R0238.0	8.00	0.3150	37.0	79.0	8.00
R0238.1	8.10	0.3189	37.0	79.0	8.10
R0238.2	8.20	0.3228	37.0	79.0	8.20
R0238.3	8.30	0.3268	37.0	79.0	8.30
R0238.4	8.40	0.3307	37.0	79.0	8.40
R0238.5	8.50	0.3346	37.0	79.0	8.50

Product	DC	DC	LCF	OAL	DCON MS
	(mm)	(inch)	(mm)	(mm)	(mm)
R0238.6	8.60	0.3386	40.0	84.0	8.60
R0238.7	8.70	0.3425	40.0	84.0	8.70
R0238.8	8.80	0.3465	40.0	84.0	8.80
R0238.9	8.90	0.3504	40.0	84.0	8.90
R0239.0	9.00	0.3543	40.0	84.0	9.00
R0239.1	9.10	0.3583	40.0	84.0	9.10
R0239.2	9.20	0.3622	40.0	84.0	9.20
R0239.3	9.30	0.3661	40.0	84.0	9.30
R0239.4	9.40	0.3701	40.0	84.0	9.40
R0239.5	9.50	0.3740	40.0	84.0	9.50
R0239.6	9.60	0.3780	43.0	89.0	9.60
R0239.7	9.70	0.3819	43.0	89.0	9.70
R0239.8	9.80	0.3858	43.0	89.0	9.80
R0239.9	9.90	0.3898	43.0	89.0	9.90
R02310.0	10.00	0.3937	43.0	89.0	10.00
R02310.2	10.20	0.4016	43.0	89.0	10.20
R02310.5	10.50	0.4134	43.0	89.0	10.50
R02311.0	11.00	0.4331	47.0	95.0	11.00
R02311.5	11.50	0.4528	47.0	95.0	11.50
R02312.0	12.00	0.4724	51.0	102.0	12.00

DRILLING FEED RATE CHART

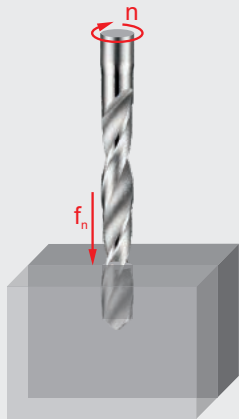

Feed per revolution (f_n in mm/rev)
Depending on the working conditions
it might be necessary to adjust these
values $\pm 25\%$.

How to use this table to find the feed per revolution (f_n):

1. Find your Alpha Code on the product page
(example: 60 T, "T" is the Alpha Code).
2. Find the closest diameter for your cutting application in the top row of the table.
3. Find your Alpha Code in the left column of the table.
4. The intersection (cell) of the Diameter and Alpha Code is the feed per revolution (f_n).

		\varnothing DC (mm)																		
		0.15	0.50	1.00	2.00	3.00	4.00	5.00	6.00	8.00	10.00	12.00	15.00	16.00	20.00	25.00	30.00	40.00	50.00	100.00
Feed rates (mm/rev)	A	0.003	0.006	0.012	0.023	0.029	0.032	0.036	0.042	0.054	0.062	0.069	0.082	0.086	0.110	0.125	0.135	0.155	0.175	0.263
	B	0.004	0.007	0.014	0.028	0.037	0.041	0.046	0.053	0.067	0.080	0.090	0.103	0.108	0.135	0.153	0.165	0.188	0.208	0.312
	C	0.004	0.008	0.015	0.032	0.044	0.050	0.056	0.064	0.080	0.098	0.110	0.125	0.130	0.160	0.180	0.195	0.220	0.240	0.360
	D	0.004	0.008	0.016	0.038	0.053	0.060	0.068	0.078	0.098	0.119	0.130	0.149	0.155	0.188	0.210	0.228	0.253	0.275	0.413
	E	0.004	0.009	0.017	0.043	0.062	0.071	0.080	0.092	0.115	0.140	0.150	0.173	0.180	0.215	0.240	0.260	0.285	0.310	0.465
	F	0.005	0.009	0.018	0.050	0.073	0.084	0.095	0.109	0.138	0.165	0.178	0.202	0.210	0.248	0.275	0.295	0.320	0.343	0.515
	G	0.005	0.010	0.019	0.056	0.084	0.096	0.109	0.126	0.160	0.190	0.205	0.231	0.240	0.280	0.310	0.330	0.355	0.375	0.563
	H	0.005	0.010	0.020	0.066	0.102	0.116	0.130	0.150	0.190	0.228	0.243	0.271	0.280	0.320	0.355	0.375	0.398	0.418	0.627
	I	0.005	0.011	0.021	0.076	0.119	0.134	0.150	0.173	0.220	0.265	0.280	0.310	0.320	0.360	0.400	0.420	0.440	0.460	0.690
	J	0.006	0.012	0.024	0.084	0.135	0.152	0.170	0.197	0.250	0.298	0.315	0.349	0.360	0.405	0.445	0.465	0.485	0.503	0.755
	K	0.007	0.013	0.026	0.092	0.150	0.170	0.190	0.220	0.280	0.330	0.350	0.388	0.400	0.450	0.490	0.510	0.530	0.545	0.818
	L	0.007	0.014	0.028	0.101	0.165	0.186	0.208	0.240	0.305	0.360	0.385	0.419	0.430	0.485	0.525	0.545	0.568	0.588	0.882
	M	0.008	0.015	0.030	0.110	0.180	0.202	0.225	0.260	0.330	0.390	0.420	0.450	0.460	0.520	0.560	0.580	0.605	0.630	0.945
	N	0.008	0.016	0.032	0.119	0.195	0.218	0.242	0.280	0.355	0.420	0.455	0.481	0.490	0.555	0.595	0.615	0.642	0.672	1.008
	S	0.002	0.004	0.008	0.014	0.020	0.025	0.030	0.037	0.050	0.080	0.100	0.123	0.130	0.150	0.170	0.190	0.220	0.240	-
	T	0.004	0.008	0.015	0.028	0.040	0.050	0.060	0.070	0.090	0.110	0.130	0.160	0.170	0.190	0.210	0.230	0.260	0.275	-
	U	0.007	0.013	0.026	0.048	0.070	0.080	0.090	0.107	0.140	0.170	0.200	0.223	0.230	0.240	0.270	0.300	0.360	0.375	-
	V	0.010	0.019	0.038	0.069	0.100	0.115	0.130	0.153	0.200	0.250	0.280	0.310	0.320	0.340	0.400	0.440	0.510	0.530	-
	W	0.012	0.025	0.049	0.089	0.130	0.150	0.170	0.200	0.260	0.330	0.380	0.418	0.430	0.450	0.470	0.490	0.520	0.540	-
	X	0.014	0.028	0.056	0.103	0.150	0.180	0.210	0.250	0.330	0.420	0.480	0.533	0.550	0.580	-	-	-	-	-
Y	0.017	0.034	0.068	0.124	0.180	0.220	0.260	0.317	0.430	0.550	0.700	0.700	0.700	0.740	-	-	-	-	-	
Z	0.024	0.047	0.094	0.172	0.250	0.325	0.400	0.533	0.800	1.000	1.100	1.175	1.200	1.200	-	-	-	-	-	



E397
E398

HIGHLY PRODUCTIVE MULTI APPLICATION TAPS (DIN)

INTRODUCTION



Introducing Dormer E397 and E398 taps – the epitome of versatility and performance. Engineered for 2.5xD tapping depth with a specific geometry to conquer medium to high strength materials while preventing oversized threads in softer ones. The modified edge treatment ensures a long tool life with consistent results, and the 3-radii flute profile provides precision and process security. With a TiCN coating for wear resistance and a unique powder metallurgy substrate, Dormer E397 and E398 taps deliver high performance without compromise.



 **DORMER**



E397(M)

- For through holes only
- Standard DIN 371 / 376
- Metric range: M3 – M30



E397(MF)

- For through holes only
- Standard DIN 374
- Metric Fine range: M8x1 – M20x1.5



E397(UNC)

- For through holes only
- Standard DIN 2184-1
- UNC range: No. 8-32 – 1/2"-13



E397(UNF)

- For through holes only
- Standard DIN 2184-1
- UNF range: 1/4"-28 – 1/2"-20



THREADING TOOLS

FEATURES AND BENEFITS

Versatile geometry prevents both clamping in medium to high strength materials, and oversized threads in soft materials.



EXCELLENT IN STEELS

and versatile for a variety of other materials.

Modified edge treatment and rounding increases cutting edge stability and reduces the risk of edge chipping.



EXTENDED TOOL LIFE

and long term consistency.

3-Radii flute profile provides maximum control of the cutting properties and secures proper swarf flow.



HIGH PROCESS RELIABILITY

secured by nesting prevention.

TiCN coating grants high wear resistance combined with low coefficient of friction.



COLD WELDING PROTECTION

throughout the whole life span.

Unique Powder Metallurgy HSS-E PM substrate provides excellent combination of toughness and edge hardness.



HIGH PERFORMANCE

without compromise on tool life.



DIN/ANSI



DIN/ANSI standard taps also available!



JIS



JIS standard taps also available!



E398(M)

- Primarily for blind holes
- Standard DIN 371 / 376
- Metric range: M3 – M30



E398(MF)

- Primarily for blind holes
- Standard DIN 374
- Metric Fine range: M8x1 – M20x1.5



E398(UNC)

- Primarily for blind holes
- Standard DIN 2184-1
- UNC range: No. 8-32 – 1/2"-13



E398(UNF)

- Primarily for blind holes
- Standard DIN 2184-1
- UNF range: 1/4"-28 – 1/2"-20



E397
E398

HIGHLY PRODUCTIVE MULTI APPLICATION TAPS (DIN)

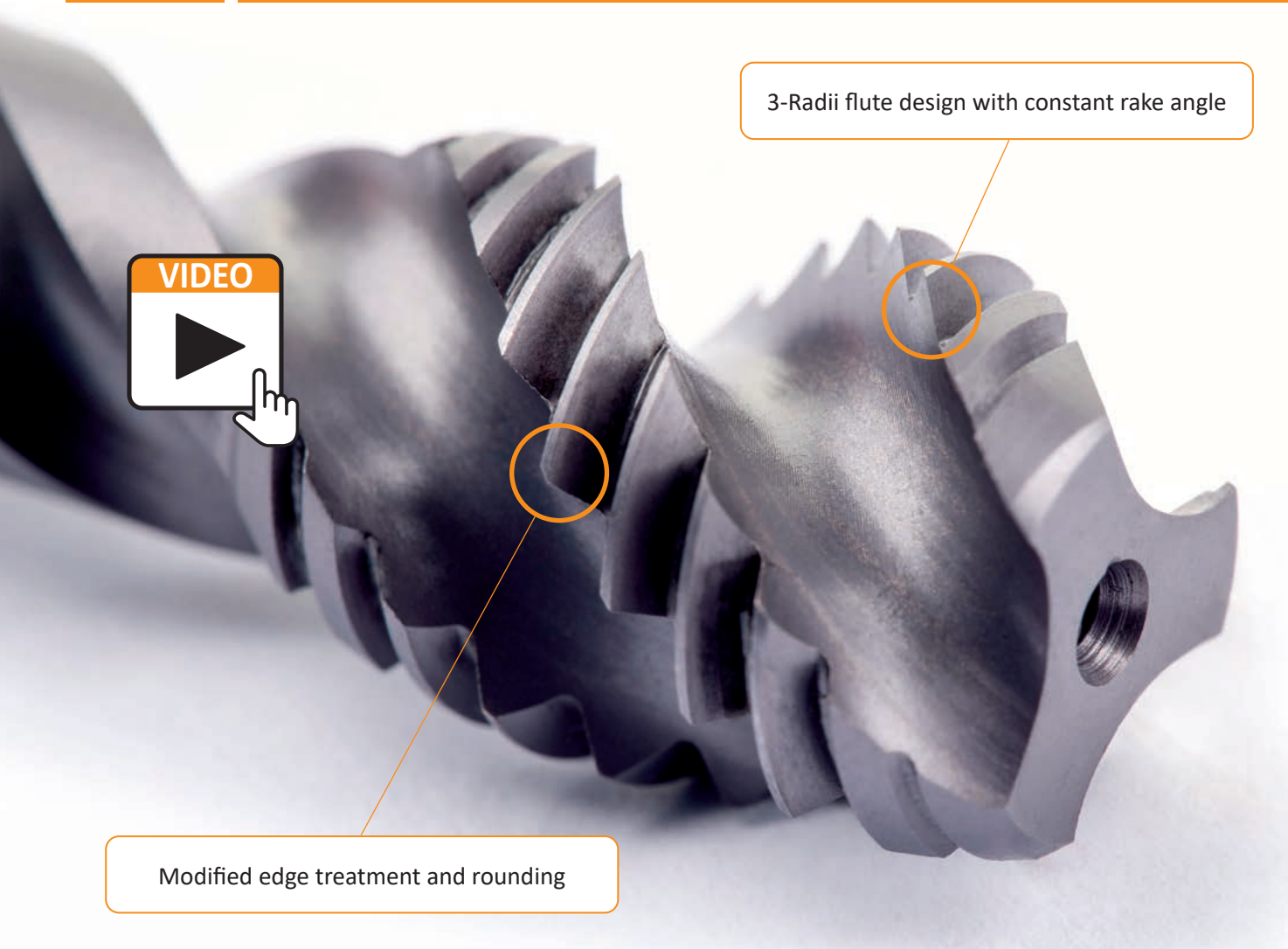

3-Radii flute design with constant rake angle

VIDEO



Modified edge treatment and rounding

SUCCESS STORY – E398

Segment:	General Engineering (Czech republic)
Component:	Hydraulic circuit parts
Material:	42CrMo4 / EN 10083 (Alloy steel, 250 HB)
Coolant:	Yes, external, water soluble oil emulsion (~8%)
Application:	Blind hole threading of M6 at 2.5xD, pre-drilled Ø 5.1 mm hole is 21 mm deep and made by solid carbide drill. Run in Tajmac MCFV 1060 CNC using a Tapmatic SynchroFlex SFT II75 tap holder.
Previous results:	Serious problems caused by nesting, an average of 1000 threads was reached current taps. The best alternative competitor tap improved tool life to 1353 threads in average, but nesting problems still remained frequent.

Result with E398: Our new tap design reached 1645 threads in average (+22%) with higher level of process security and limited nesting, which sum-up in improved productivity!

Dormer Pramet solution:

E398M6

Machining data:

v_c	td
15	15

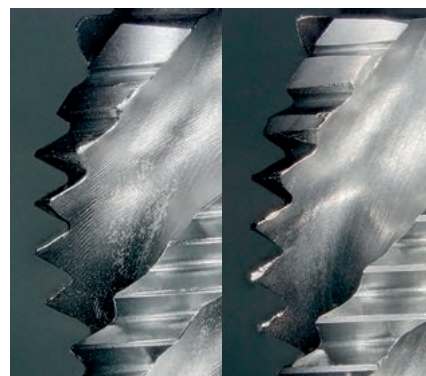

DORMER
after 944 threads

COMPETITOR
after 944 threads

WMG P3.2



Thread form (THFT)									
Basic standard group (BSG)		DIN 371/376	DIN 374	DIN 2184-1	DIN 2184-1	DIN 371/376	DIN 374	DIN 2184-1	DIN 2184-1
Thread tolerance class (TCTR)		6HX	6HX	2BX	2BX	6HX	6HX	2BX	2BX
Threading application									
Usable length (ULDR)		2.5×D	2.5×D	2.5×D	2.5×D	2.5×D	2.5×D	2.5×D	2.5×D
Material code (BMC)		HSS-E PM	HSS-E PM	HSS-E PM	HSS-E PM	HSS-E PM	HSS-E PM	HSS-E PM	HSS-E PM
Tap chamfer style (TCS)		B 3.5-5	B 3.5-5	B 3.5-5	B 3.5-5	C 2-3	C 2-3	C 2-3	C 2-3
Flute Geometry (FDC)									
Flute helix angle (FHA)						λ 48°	λ 48°	λ 48°	λ 48°
Hand (Cutting direction)									
Coating									
Product Family Code		E397(M)	E397(MF)	E397(UNC)	E397(UNF)	E398(M)	E398(MF)	E398(UNC)	E398(UNF)
PSF cutting diameters range		M3 – M30	M8 – M20	No.8 – 1/2"	1/4 – 1/2"	M3 – M30	M8 – M20	No.8 – 1/2"	1/4 – 1/2"
P	P1	■	■	■	■	■	■	■	■
	P2	■	■	■	■	■	■	■	■
	P3	■	■	■	■	■	■	■	■
	P4	■	■	■	■	■	■	■	■
M	M1	■	■	■	■	■	■	■	■
	M2	■	■	■	■	■	■	■	■
	M3	■	■	■	■	■	■	■	■
	M4	☑	☑	☑	☑	☑	☑	☑	☑
K	K1	☑	☑	☑	☑				
	K2	☑	☑	☑	☑				
	K3	☑	☑	☑	☑				
	K4	☑	☑	☑	☑				
	K5								
N	N1	☑	☑	☑	☑	☑	☑	☑	☑
	N2	☑	☑	☑	☑	☑	☑	☑	☑
	N3	☑	☑	☑	☑	☑	☑	☑	☑
	N4	☑	☑	☑	☑				
	N5								
S	S1								
	S2								
	S3								
	S4								
H	H1								
	H2								
	H3								
	H4								

■ Primary use ☑ Possible use



E397(M)



HSS-E-PM Spiral Point Tap, Metric, DIN Standard, TiCN Coated

Machine tap for highly productive applications with spiral point for 2.5xD through holes only. Suited for machining a variety of work-materials. Unique TiCN coated HSS-E-PM substrate to offer superior abrasion resistance, higher cutting speeds, improve thread quality, reduced cycle times and longer tool-life.

	DIN 371/376	6HX
	2.5xD	HSS-E-PM
	B 3.5-5	

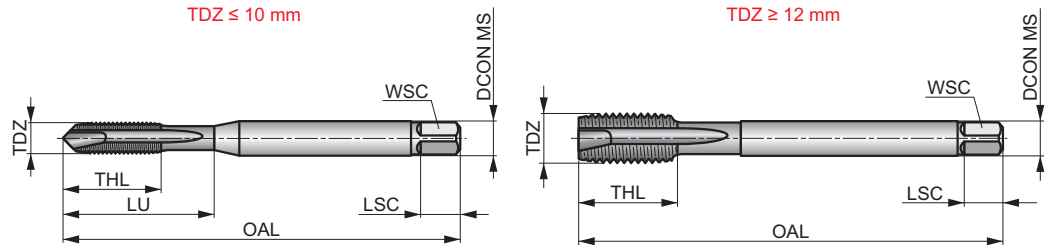

Workpiece material group suitability and starting values for cutting speed (m/min).

P1.1 ■ 37	P1.2 ■ 42	P1.3 ■ 44	P2.1 ■ 33	P2.2 ■ 28	P2.3 ■ 25	P3.1 ■ 20	P3.2 ■ 16	P3.3 ▣ 13	P4.1 ■ 12	P4.2 ▣ 9	M1.1 ■ 15	M1.2 ■ 12	M2.1 ■ 13
M2.2 ■ 11	M3.1 ■ 9	M3.2 ■ 7	M3.3 ▣ 6	M4.1 ▣ 4	K1.1 ▣ 20	K1.2 ▣ 15	K1.3 ▣ 11	K2.1 ▣ 29	K2.2 ▣ 23	K3.1 ▣ 25	K3.2 ▣ 19	K4.1 ▣ 23	K4.2 ▣ 17
N1.3 ▣ 12	N2.1 ▣ 37	N2.2 ▣ 34	N2.3 ▣ 24	N3.1 ▣ 60	N3.2 ▣ 36	N4.1 ▣ 26							

Product	TDZ	TP	OAL	THL	DCON MS	WSC	LSC	NOF	PHD	LU
E397M3	3	0.50	56.0	9	3.50	2.70	6	3	2.50	18.00
E397M4	4	0.70	63.0	12	4.50	3.40	6	3	3.30	21.00
E397M5	5	0.80	70.0	13	6.00	4.90	8	3	4.20	25.00
E397M6	6	1.00	80.0	15	6.00	4.90	8	3	5.00	30.00
E397M8	8	1.25	90.0	18	8.00	6.20	9	3	6.80	35.00
E397M10	10	1.50	100.0	20	10.00	8.00	11	3	8.50	39.00
E397M12	12	1.75	110.0	23	9.00	7.00	10	4	10.30	–
E397M14	14	2.00	110.0	25	11.00	9.00	12	4	12.00	–
E397M16	16	2.00	110.0	25	12.00	9.00	12	4	14.00	–
E397M18	18	2.50	125.0	30	14.00	11.00	14	4	15.50	–
E397M20	20	2.50	140.0	30	16.00	12.00	15	4	17.50	–
E397M22	22	2.50	140.0	34	18.00	14.50	17	4	19.50	–
E397M24	24	3.00	160.0	38	18.00	14.50	17	4	21.00	–
E397M27	27	3.00	160.0	38	20.00	16.00	19	4	24.00	–
E397M30	30	3.50	180.0	45	22.00	18.00	21	4	26.50	–



E397(MF)



HSS-E-PM Spiral Point Tap, Metric Fine, DIN Standard, TiCN Coated

Machine tap for highly productive applications with spiral point for 2.5xD through holes only. Suited for machining a variety of work-materials. Unique TiCN coated HSS-E-PM substrate to offer superior abrasion resistance, higher cutting speeds, improve thread quality, reduced cycle times and longer tool-life.

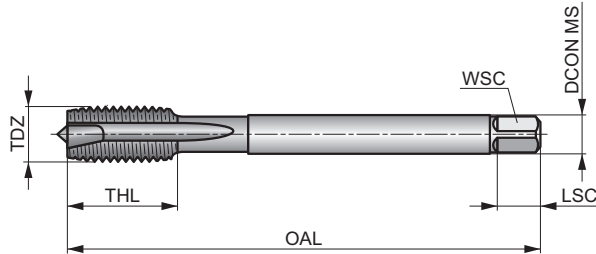

	DIN 374	6HX
	2.5xD	HSS-E PM
B 3.5-5		

Workpiece material group suitability and starting values for cutting speed (m/min).

P1.1 ■ 37	P1.2 ■ 42	P1.3 ■ 44	P2.1 ■ 33	P2.2 ■ 28	P2.3 ■ 25	P3.1 ■ 20	P3.2 ■ 16	P3.3 ■ 13	P4.1 ■ 12	P4.2 ■ 9	M1.1 ■ 15	M1.2 ■ 12	M2.1 ■ 13
M2.2 ■ 11	M3.1 ■ 9	M3.2 ■ 7	M3.3 ■ 6	M4.1 ■ 4	K1.1 ■ 20	K1.2 ■ 15	K1.3 ■ 11	K2.1 ■ 29	K2.2 ■ 23	K3.1 ■ 25	K3.2 ■ 19	K4.1 ■ 23	K4.2 ■ 17
N1.3 ■ 12	N2.1 ■ 37	N2.2 ■ 34	N2.3 ■ 24	N3.1 ■ 60	N3.2 ■ 36	N4.1 ■ 26							

Product	TDZ	TP	OAL	THL	DCON MS	WSC	LSC	NOF	PHD
		(mm)	(mm)	(mm)	(mm)	(mm)	(mm)		(mm)
E397M8X1.0	8	1.00	90.0	18	6.00	4.90	8	3	7.00
E397M10X1.0	10	1.00	90.0	18	7.00	5.50	8	3	9.00
E397M10X1.25	10	1.25	100.0	20	7.00	5.50	8	3	8.80
E397M12X1.0	12	1.00	100.0	21	9.00	7.00	10	4	11.00
E397M12X1.25	12	1.25	100.0	21	9.00	7.00	10	4	10.80
E397M12X1.5	12	1.50	100.0	21	9.00	7.00	10	4	10.50
E397M14X1.5	14	1.50	100.0	21	11.00	9.00	12	4	12.50
E397M16X1.5	16	1.50	100.0	21	12.00	9.00	12	4	14.50
E397M20X1.5	20	1.50	125.0	24	16.00	12.00	15	4	18.50



E397(UNC)



HSS-E-PM Spiral Point Tap, UNC, DIN Standard, TiCN Coated

Machine tap for highly productive applications with spiral point for 2.5xD through holes only. Suited for machining a variety of work-materials. Unique TiCN coated HSS-E-PM substrate to offer superior abrasion resistance, higher cutting speeds, improve thread quality, reduced cycle times and longer tool-life.

	DIN 2184-1	2BX
	2.5xD	HSS-E PM
B 3.5-5		
TiCN		

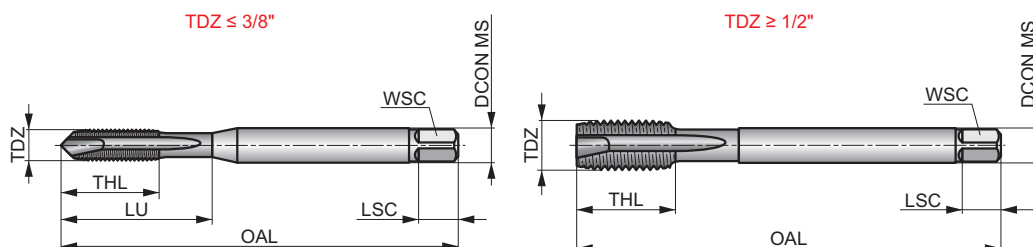

Workpiece material group suitability and starting values for cutting speed (m/min).

P1.1 ■ 37	P1.2 ■ 42	P1.3 ■ 44	P2.1 ■ 33	P2.2 ■ 28	P2.3 ■ 25	P3.1 ■ 20	P3.2 ■ 16	P3.3 ▣ 13	P4.1 ■ 12	P4.2 ▣ 9	M1.1 ■ 15	M1.2 ■ 12	M2.1 ■ 13
M2.2 ■ 11	M3.1 ■ 9	M3.2 ■ 7	M3.3 ▣ 6	M4.1 ▣ 4	K1.1 ▣ 20	K1.2 ▣ 15	K1.3 ▣ 11	K2.1 ▣ 29	K2.2 ▣ 23	K3.1 ▣ 25	K3.2 ▣ 19	K4.1 ▣ 23	K4.2 ▣ 17
N1.3 ▣ 12	N2.1 ▣ 37	N2.2 ▣ 34	N2.3 ▣ 24	N3.1 ▣ 60	N3.2 ▣ 36	N4.1 ▣ 26							

Product	TDZ	TPI	TD	OAL	THL	DCON MS	WSC	LSC	NOF	PHD	LU
			(mm)	(mm)	(mm)	(mm)	(mm)	(mm)		(mm)	(mm)
E397UNC8X32	8	32	4.17	63.0	12	4.50	3.40	6	3	3.50	21.00
E397UNC10X24	10	24	4.83	70.0	13	6.00	4.90	8	3	3.90	25.00
E397UNC1/4	1/4	20	6.35	80.0	15	7.00	5.50	8	3	5.10	30.00
E397UNC5/16	5/16	18	7.94	90.0	18	8.00	6.20	9	3	6.60	35.00
E397UNC3/8	3/8	16	9.53	100.0	20	10.00	8.00	11	3	8.00	39.00
E397UNC1/2	1/2	13	12.70	110.0	23	9.00	7.00	10	4	10.80	-



E397(UNF)



HSS-E-PM Spiral Point Tap, UNF, DIN Standard, TiCN Coated

Machine tap for highly productive applications with spiral point for 2.5xD through holes only. Suited for machining a variety of work-materials. Unique TiCN coated HSS-E-PM substrate to offer superior abrasion resistance, higher cutting speeds, improve thread quality, reduced cycle times and longer tool-life.

	DIN 2184-1	2BX
	2.5xD	HSS-E-PM
B 3.5-5		

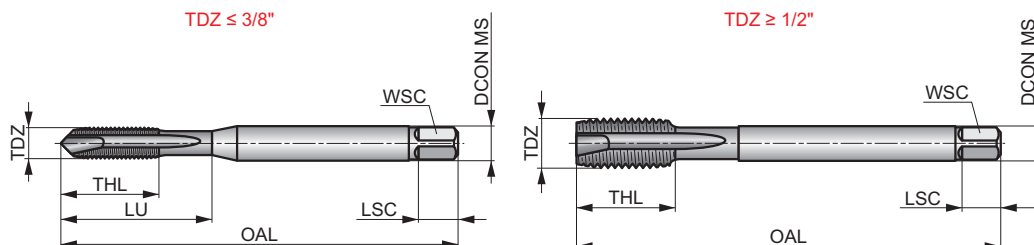

Workpiece material group suitability and starting values for cutting speed (m/min).

P1.1 ■ 37	P1.2 ■ 42	P1.3 ■ 44	P2.1 ■ 33	P2.2 ■ 28	P2.3 ■ 25	P3.1 ■ 20	P3.2 ■ 16	P3.3 ▣ 13	P4.1 ■ 12	P4.2 ▣ 9	M1.1 ■ 15	M1.2 ■ 12	M2.1 ■ 13
M2.2 ■ 11	M3.1 ■ 9	M3.2 ■ 7	M3.3 ▣ 6	M4.1 ▣ 4	K1.1 ▣ 20	K1.2 ▣ 15	K1.3 ▣ 11	K2.1 ▣ 29	K2.2 ▣ 23	K3.1 ▣ 25	K3.2 ▣ 19	K4.1 ▣ 23	K4.2 ▣ 17
N1.3 ▣ 12	N2.1 ▣ 37	N2.2 ▣ 34	N2.3 ▣ 24	N3.1 ▣ 60	N3.2 ▣ 36	N4.1 ▣ 26							

Product	TDZ	TPI	TD	OAL	THL	DCON MS	WSC	LSC	NOF	PHD	LU
			(mm)	(mm)	(mm)	(mm)	(mm)	(mm)		(mm)	(mm)
E397UNF1/4	1/4	28	6.35	80.0	15	7.00	5.50	8	3	5.50	30.00
E397UNF5/16	5/16	24	7.94	90.0	18	8.00	6.20	9	3	6.90	35.00
E397UNF3/8	3/8	24	9.53	100.0	20	10.00	8.00	11	3	8.50	39.00
E397UNF1/2	1/2	20	12.70	110.0	23	9.00	7.00	10	4	11.50	-



E398(M)



HSS-E-PM Spiral Flute Tap, Metric, DIN Standard, TiCN Coated

Machine tap for highly productive applications with spiral flute for 2.5xD blind holes. Suited for a variety of work-materials. Unique TiCN coated HSS-E-PM to offer superior abrasion resistance, higher cutting speeds, improve thread quality, reduced cycle times and longer tool-life. Recommended for synchronous feed tap holders.

	DIN 371/376	6HX
	2.5xD	HSS-E PM
		λ 48°
	TiCN	

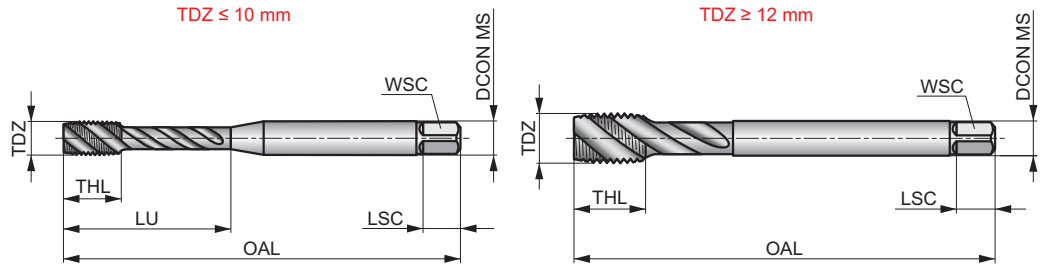

Workpiece material group suitability and starting values for cutting speed (m/min).

P1.1 ■ 35	P1.2 ■ 40	P1.3 ■ 42	P2.1 ■ 31	P2.2 ■ 27	P2.3 ■ 24	P3.1 ■ 19	P3.2 ■ 15	P3.3 ■ 12	P4.1 ■ 11	P4.2 ■ 9	M1.1 ■ 14	M1.2 ■ 11	M2.1 ■ 12
M2.2 ■ 10	M3.1 ■ 9	M3.2 ■ 7	M3.3 ■ 6	M4.1 ■ 4	N1.3 ■ 11	N2.1 ■ 35	N2.2 ■ 32	N2.3 ■ 23	N3.1 ■ 60				

Product	TDZ	TP	OAL	THL	DCON MS	WSC	LSC	NOF	PHD	LU
		(mm)	(mm)	(mm)	(mm)	(mm)	(mm)		(mm)	(mm)
E398M3	3	0.50	56.0	6	3.50	2.70	6	3	2.50	18.00
E398M4	4	0.70	63.0	7	4.50	3.40	6	3	3.30	21.00
E398M5	5	0.80	70.0	8	6.00	4.90	8	3	4.20	25.00
E398M6	6	1.00	80.0	10	6.00	4.90	8	3	5.00	31.00
E398M8	8	1.25	90.0	12	8.00	6.20	9	3	6.80	35.00
E398M10	10	1.50	100.0	15	10.00	8.00	11	3	8.50	39.00
E398M12	12	1.75	110.0	16	9.00	7.00	10	3	10.30	–
E398M14	14	2.00	110.0	20	11.00	9.00	12	3	12.00	–
E398M16	16	2.00	110.0	20	12.00	9.00	12	4	14.00	–
E398M18	18	2.50	125.0	25	14.00	11.00	14	4	15.50	–
E398M20	20	2.50	140.0	25	16.00	12.00	15	4	17.50	–
E398M22	22	2.50	140.0	25	18.00	14.50	17	4	19.50	–
E398M24	24	3.00	160.0	30	18.00	14.50	17	4	21.00	–
E398M27	27	3.00	160.0	30	20.00	16.00	19	4	24.00	–
E398M30	30	3.50	180.0	36	22.00	18.00	21	4	26.50	–



E398(MF)



HSS-E-PM Spiral Flute Tap, Metric Fine, DIN Standard, TiCN Coated

Machine tap for highly productive applications with spiral flute for 2.5xD blind holes. Suited for a variety of work-materials. Unique TiCN coated HSS-E-PM to offer superior abrasion resistance, higher cutting speeds, improve thread quality, reduced cycle times and longer tool-life. Recommended for synchronous feed tap holders.

	DIN 374	6HX
	2.5xD	HSS-E PM
C 2-3		λ 48°

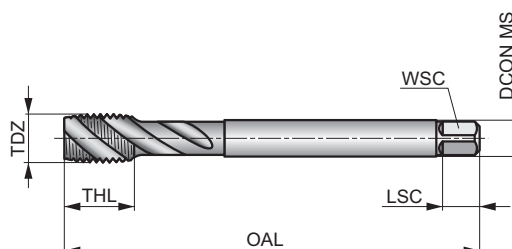

Workpiece material group suitability and starting values for cutting speed (m/min).

P1.1 ■ 35	P1.2 ■ 40	P1.3 ■ 42	P2.1 ■ 31	P2.2 ■ 27	P2.3 ■ 24	P3.1 ■ 19	P3.2 ■ 15	P3.3 ■ 12	P4.1 ■ 11	P4.2 ■ 9	M1.1 ■ 14	M1.2 ■ 11	M2.1 ■ 12
M2.2 ■ 10	M3.1 ■ 9	M3.2 ■ 7	M3.3 ■ 6	M4.1 ■ 4	N1.3 ■ 11	N2.1 ■ 35	N2.2 ■ 32	N2.3 ■ 23	N3.1 ■ 160				

Product	TDZ	TP	OAL	THL	DCON MS	WSC	LSC	NOF	PHD
E398M8X1.0	8	1.00	90.0	13	6.00	4.90	8	3	7.00
E398M10X1.0	10	1.00	90.0	13	7.00	5.50	8	3	9.00
E398M10X1.25	10	1.25	100.0	15	7.00	5.50	8	3	8.80
E398M12X1.0	12	1.00	100.0	15	9.00	7.00	10	3	11.00
E398M12X1.25	12	1.25	100.0	15	9.00	7.00	10	3	10.80
E398M12X1.5	12	1.50	100.0	15	9.00	7.00	10	3	10.50
E398M14X1.5	14	1.50	100.0	15	11.00	9.00	12	3	12.50
E398M16X1.5	16	1.50	100.0	15	12.00	9.00	12	4	14.50
E398M20X1.5	20	1.50	125.0	17	16.00	12.00	15	4	18.50



E398(UNC)



HSS-E-PM Spiral Flute Tap, UNC, DIN Standard, TiCN Coated

Machine tap for highly productive applications with spiral flute for 2.5xD blind holes. Suited for a variety of work-materials. Unique TiCN coated HSS-E-PM to offer superior abrasion resistance, higher cutting speeds, improve thread quality, reduced cycle times and longer tool-life. Recommended for synchronous feed tap holders.

	DIN 2184-1	2BX
	2.5xD	HSS-E PM
		λ 48°

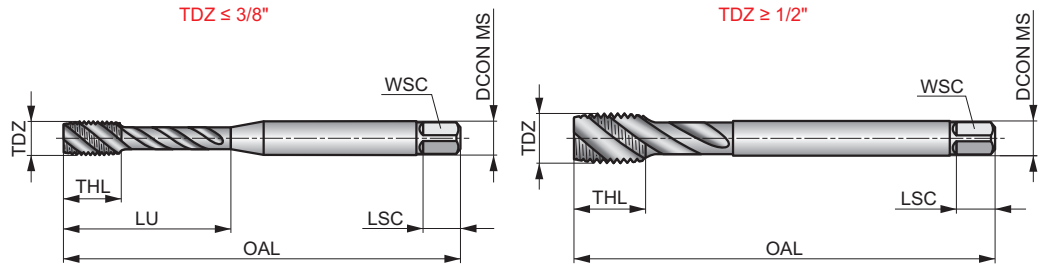

Workpiece material group suitability and starting values for cutting speed (m/min).

P1.1 ■ 35	P1.2 ■ 40	P1.3 ■ 42	P2.1 ■ 31	P2.2 ■ 27	P2.3 ■ 24	P3.1 ■ 19	P3.2 ■ 15	P3.3 ■ 12	P4.1 ■ 11	P4.2 ■ 9	M1.1 ■ 14	M1.2 ■ 11	M2.1 ■ 12
M2.2 ■ 10	M3.1 ■ 9	M3.2 ■ 7	M3.3 ■ 6	M4.1 ■ 4	N1.3 ■ 11	N2.1 ■ 35	N2.2 ■ 32	N2.3 ■ 23	N3.1 ■ 60				

Product	TDZ	TPI	TD	OAL	THL	DCON MS	WSC	LSC	NOF	PHD	LU
			(mm)	(mm)	(mm)	(mm)	(mm)	(mm)		(mm)	(mm)
E398UNC8X32	8	32	4.17	63.0	7	4.50	3.40	6	3	3.50	21.00
E398UNC10X24	10	24	4.83	70.0	8	6.00	4.90	8	3	3.90	25.00
E398UNC1/4	1/4	20	6.35	80.0	10	7.00	5.50	8	3	5.10	30.00
E398UNC5/16	5/16	18	7.94	90.0	12	8.00	6.20	9	3	6.60	35.00
E398UNC3/8	3/8	16	9.53	100.0	15	10.00	8.00	11	3	8.00	39.00
E398UNC1/2	1/2	13	12.70	110.0	18	9.00	7.00	10	3	10.80	-



E398(UNF)



HSS-E-PM Spiral Flute Tap, UNF, DIN Standard, TiCN Coated

Machine tap for highly productive applications with spiral flute for 2.5xD blind holes. Suited for a variety of work-materials. Unique TiCN coated HSS-E-PM to offer superior abrasion resistance, higher cutting speeds, improve thread quality, reduced cycle times and longer tool-life. Recommended for synchronous feed tap holders.

	DIN 2184-1	2BX
	2.5xD	HSS-E PM
C 2-3		λ 48°

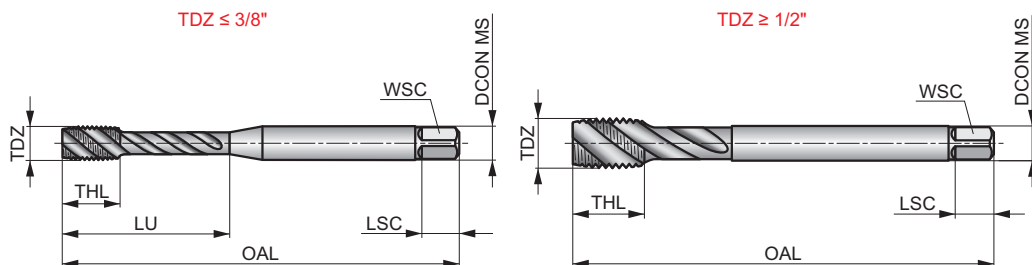

Workpiece material group suitability and starting values for cutting speed (m/min).

P1.1 ■ 35	P1.2 ■ 40	P1.3 ■ 42	P2.1 ■ 31	P2.2 ■ 27	P2.3 ■ 24	P3.1 ■ 19	P3.2 ■ 15	P3.3 ▣ 12	P4.1 ■ 11	P4.2 ▣ 9	M1.1 ■ 14	M1.2 ■ 11	M2.1 ■ 12
M2.2 ■ 10	M3.1 ■ 9	M3.2 ■ 7	M3.3 ▣ 6	M4.1 ▣ 4	N1.3 ▣ 11	N2.1 ▣ 35	N2.2 ▣ 32	N2.3 ▣ 23	N3.1 ▣ 160				

Product	TDZ	TPI	TD	OAL	THL	DCON MS	WSC	LSC	NOF	PHD	LU
			(mm)	(mm)	(mm)						
E398UNF1/4	1/4	28	6.35	80.0	10	7.00	5.50	8	3	5.50	30.00
E398UNF5/16	5/16	24	7.94	90.0	12	8.00	6.20	9	3	6.90	35.00
E398UNF3/8	3/8	24	9.53	100.0	15	10.00	8.00	11	3	8.50	39.00
E398UNF1/2	1/2	20	12.70	110.0	18	9.00	7.00	10	3	11.50	-



T8415

VERSATILE PVD TURNING GRADE

INTRODUCTION



Introducing the Pramet T8415, our cutting-edge PVD turning grade. Versatile across steels, stainless steels, and heat-resistant super alloys (HRSA), it minimizes friction with a top TiBN layer and optimizes performance in lighter cuts across many types of workpiece materials. With a wide chip-breaker range in positive and negative ISO inserts, the T8415 redefines turning performance and efficiency.



APPLICATION AREA OF PVD GRADES

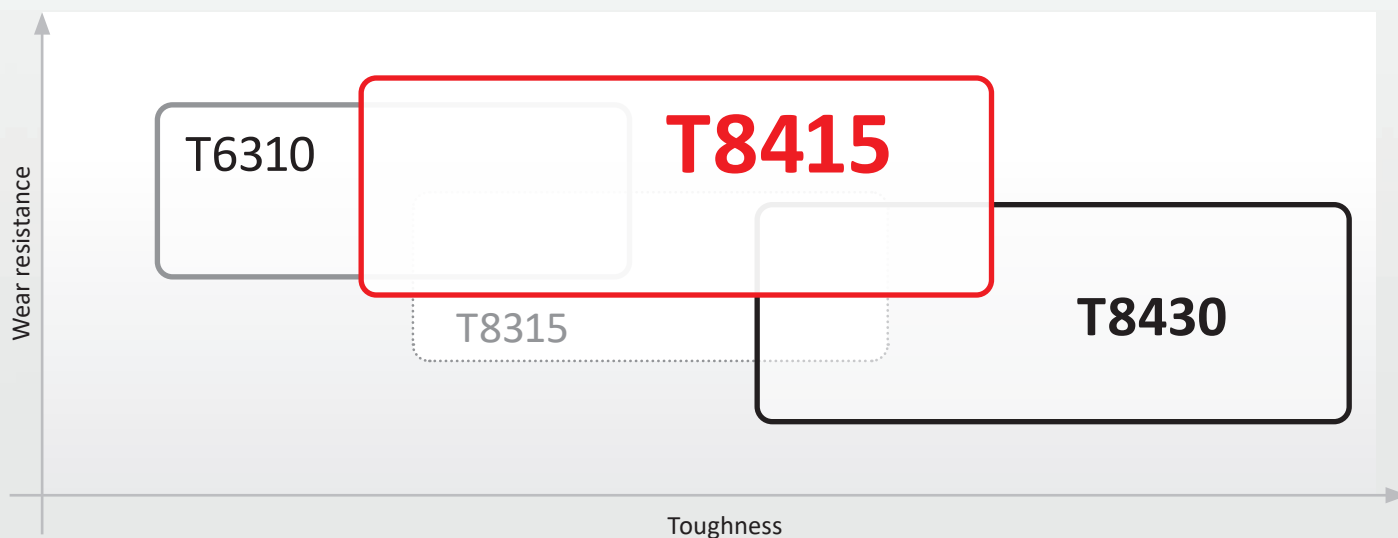



TURNING INSERTS

FEATURES AND BENEFITS

New generation multi-layered PVD coating combined with high-end sub-micron carbide grade.



VERSATILE USE

for a broad range of workpieces.

Unique TiBN sliding top layer reduces build-up edge.



IMPROVED SECURITY

in medium and high cutting speeds with coolant.

Thick TiN layer with low compressive residual stress.



LONG TOOL LIFE

even in adverse cutting conditions.

Hard AlTiN layer with newly developed composition.



HIGH WEAR RESISTANCE

against abrasive and thermal wear.

High-end ion cleaning improves adhesion of the coating to the substrate.



PROCESS REPEATABILITY

and long-term stability of tool life.

- Unique TiBN sliding layer
- Thick TiN layer
- Hard AlTiN layer

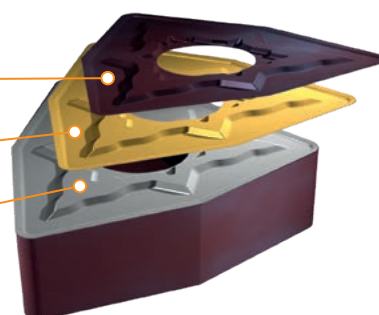

TECHNICAL INFORMATION

Grade code	Application area	Application	Feed	Cutting speed	Resistance to adverse working conditions	Coating	Colour	Substrate	Coolant benefit
T8415	P05 – P20	■				PVD		submicron H	++
	M05 – M20	■							
	K05 – K25	■							
	N05 – N25	■							
	S05 – S15	■							
H05 – H15	■								

Grade description

A versatile, high performance turning grade primarily intended for steel machining, but well suitable for stainless steels and heat resistant super alloys (HRSA) too, possibly applicable for hardened steels. It is suitable for machining at wide range of cutting speeds, light to medium feeds and under good cutting conditions, preferably with coolant.



T8415

VERSATILE PVD TURNING GRADE

SUCCESS STORIES – T8415

Segment: Automotive parts sub-contractor (India)
Component: Slim intermediate shaft
Material: EN8 / C40 / 1.0511 (Carbon steel, 220 HB)
Coolant: Yes, water soluble oil emulsion (8%)
Application: Outer diameter semi-finish turning
Previous results: Customer had stable tool life at 160 workpieces per cutting edge with competitor insert, which was satisfactory at the time.

Results with T8415: One cutting edge of the Pramet insert has 120% tool life, but with an even higher feed rate, which boosted productivity to 125%!

Dormer Pramet solution:

DNMG 150608E-SM:T8415

Machining data:

v_c	f_n	a_p
250	0.25	0.5



WMG P2.2

Segment: Petrochemical industry sub-contractor (Brazil)
Component: Pump flange
Material: AISI 316 (Forged stainless steel, 210 HB)
Coolant: Yes, water soluble oil emulsion (12%)
Application: External turning with interruptions
Previous results: Competing inserts had problems keeping tool life at an acceptable level, especially with interrupted cutting that caused the insert to break suddenly.

Results with T8415: Our PVD inserts do not break during interrupted cuts and have 120% overall life than the second best competing insert tested!

Dormer Pramet solution:

WNMG 080408E-SM:T8415

Machining data:

v_c	f_n	a_p
55	0.3	3.0



WMG M3.2

Segment: Maintenance and repair sub-contractor (Brazil)
Component: Repair of press machine shaft with weld-on layer
Material: CrV weld (55 HRC)
Coolant: No
Application: Interrupted cut of weld-on layer with crust on top
Previous results: The competitors CVD grade had quite satisfactory results and a stable tool life ending at 10 minutes.

Results with T8415: We achieved almost triple the tool life compared to the competition, increasing from 10 to 28 minutes! The customer is thrilled with this result and can't wait to buy our insert and use it for such demanding jobs.

Dormer Pramet solution:

TNMG 160404E-FM:T8415

Machining data:

v_c	f_n	a_p
25	0.15	0.4

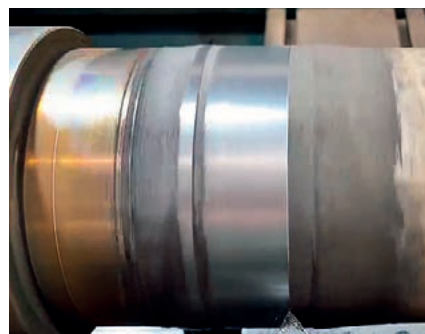

WMG H3.2



TURNING INSERTS

Segment: Automotive parts mass producer (Brazil)
Component: Trapezoidal connecting rod
Material: SAE 4140 (Alloy steel, 250 HB)
Coolant: Yes, water soluble oil emulsion (8%)
Application: Hole diameter boring
Previous results: The setup is very strict and all aspects of machining productivity vs. economy are taken into account. The competitor insert has tool life stability for 100 workpieces.

Results with T8415: After long-term testing, the Pramet insert confirms a stable tool life of 130 workpieces, which is 130% to a competing PVD insert of similar type!

Dormer Pramet solution:
TCMT 110204E-FM:T8415

Machining data:		
v_c	f_n	a_p
216	0.07	1.0



WMG P3.2

Segment: Oil & gas industry parts producer (France)
Component: Shaft for extremely corrosive environment
Material: Inconel 718 (Ni-based HRSA, 36 HRC)
Coolant: Yes, water soluble oil emulsion (12%)
Application: Continuous longitudinal roughing
Previous results: The competing insert had a tool life set to 12 minutes for process safety. The customer needs to avoid sudden breakage because the workpiece is very expensive.

Results with T8415: Long-term repeated testing has shown that we are able to achieve double tool life with the same cutting parameters without any problem or sudden failure.

Dormer Pramet solution:
SNMG 120408E-SM:T8415

Machining data:		
v_c	f_n	a_p
40	0.25	2.5



WMG S3.2

Segment: Chemical industry sub-contractor (Poland)
Component: Sleeve for chemicals pump shaft
Material: Hastelloy C-276 weld-on layer
Coolant: Yes, water soluble oil emulsion (8%)
Application: Continuous longitudinal semi-roughing
Previous results: All competing inserts failed to complete a single pass through the welded layer, which is 70 mm long. The best competitor lasts up to 30 mm, then burns out from the heat.

Results with T8415: Long-term repeated testing has shown that we are able to achieve double tool life with the same cutting parameters without any problem or sudden failure.

Dormer Pramet solution:
CNMG 120408E-NF:T8415

Machining data:		
v_c	f_n	a_p
10	0.12 – 0.15	1.0

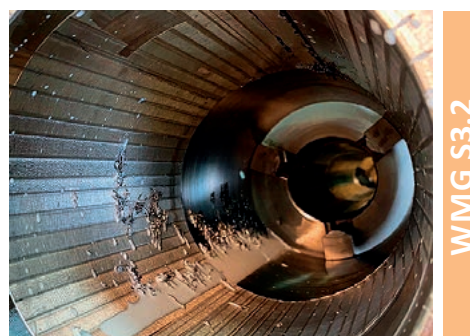

WMG S3.2



ISO INSERTS POSITIVE – CHIPBREAKER NAVIGATOR

 Very unstable working conditions





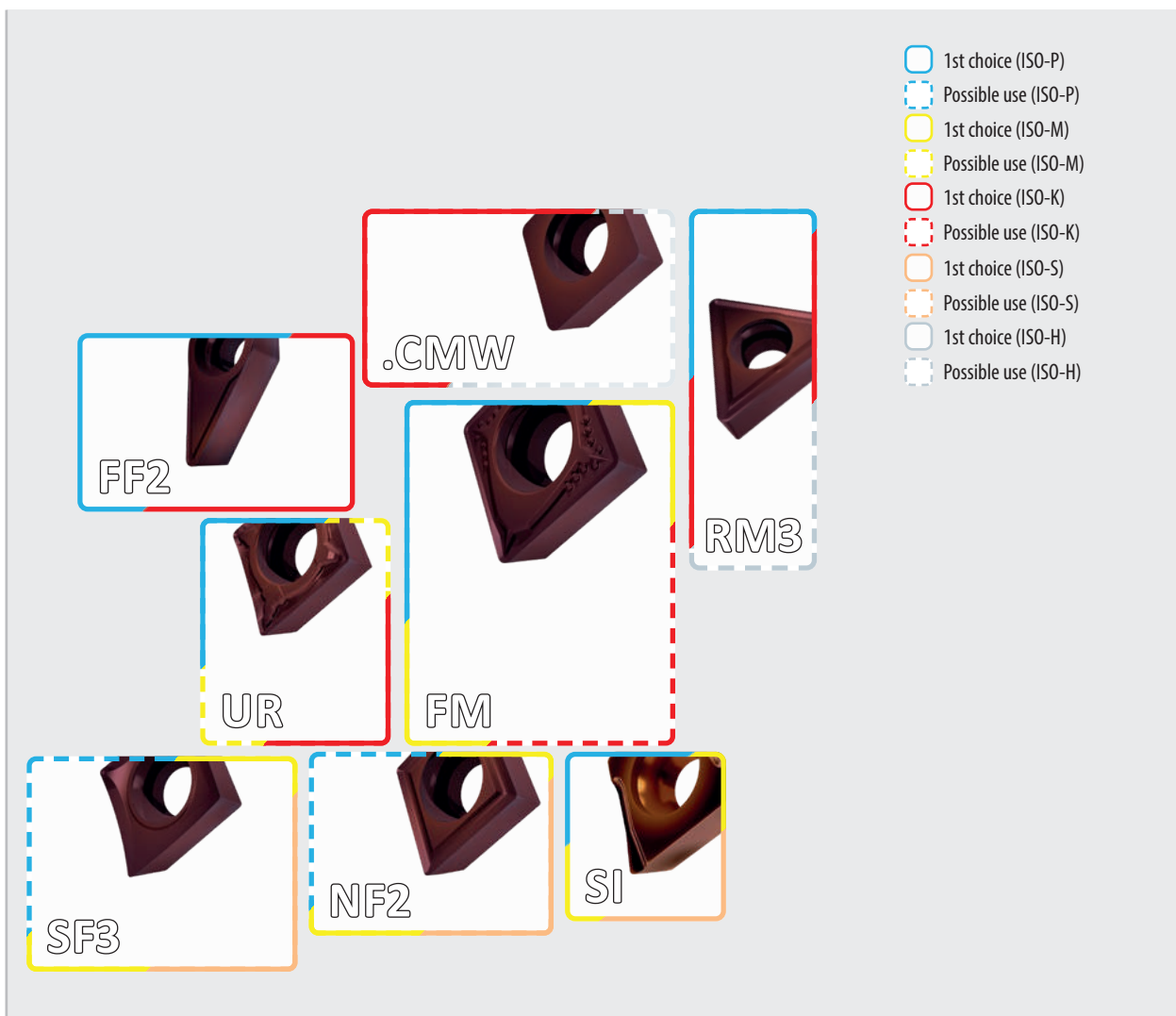

 Unstable working conditions

 Stable working conditions

 Thin-walled and slim workpieces

-  1st choice (ISO-P)
-  Possible use (ISO-P)
-  1st choice (ISO-M)
-  Possible use (ISO-M)
-  1st choice (ISO-K)
-  Possible use (ISO-K)
-  1st choice (ISO-S)
-  Possible use (ISO-S)
-  1st choice (ISO-H)
-  Possible use (ISO-H)

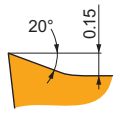
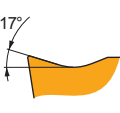
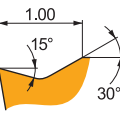

					
	0.05 – 0.2 mm/rev		0.2 – 0.4 mm/rev	0.4 – 1.0 mm/rev	> 1.0 mm/rev
	0.05 – 2 mm		2 – 4 mm	4 – 10 mm	> 10 mm

SF3		Highly positive precisely ground design for fine finishing continuous cuts, suitable for super alloys, stainless steels and non-ferrous materials, potentially steel, cast irons and hard materials.
NF2		Positive design for fine finishing up to medium continuous cuts, suitable for stainless steels and super alloys, potentially steels.
UR		Positive design for fine finishing up to semi-roughing continuous cuts, suitable for steels, potentially stainless steels and cast irons.

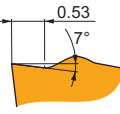
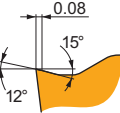
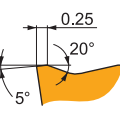
FF2		Slightly positive design for fine finishing up to medium continuous cuts, suitable for steels, potentially cast irons.
FM		Versatile design for moderately interrupted finishing cuts up to continuous semi-rough cuts, suitable for steels and stainless steels, potentially cast irons and non-ferrous materials.
RM3		Robust design with negative T-land for medium up to rough interrupted cuts, suitable for cast irons, steels, potentially hard materials.





ISO INSERTS NEGATIVE – CHIPBREAKER NAVIGATOR

 Very unstable working conditions





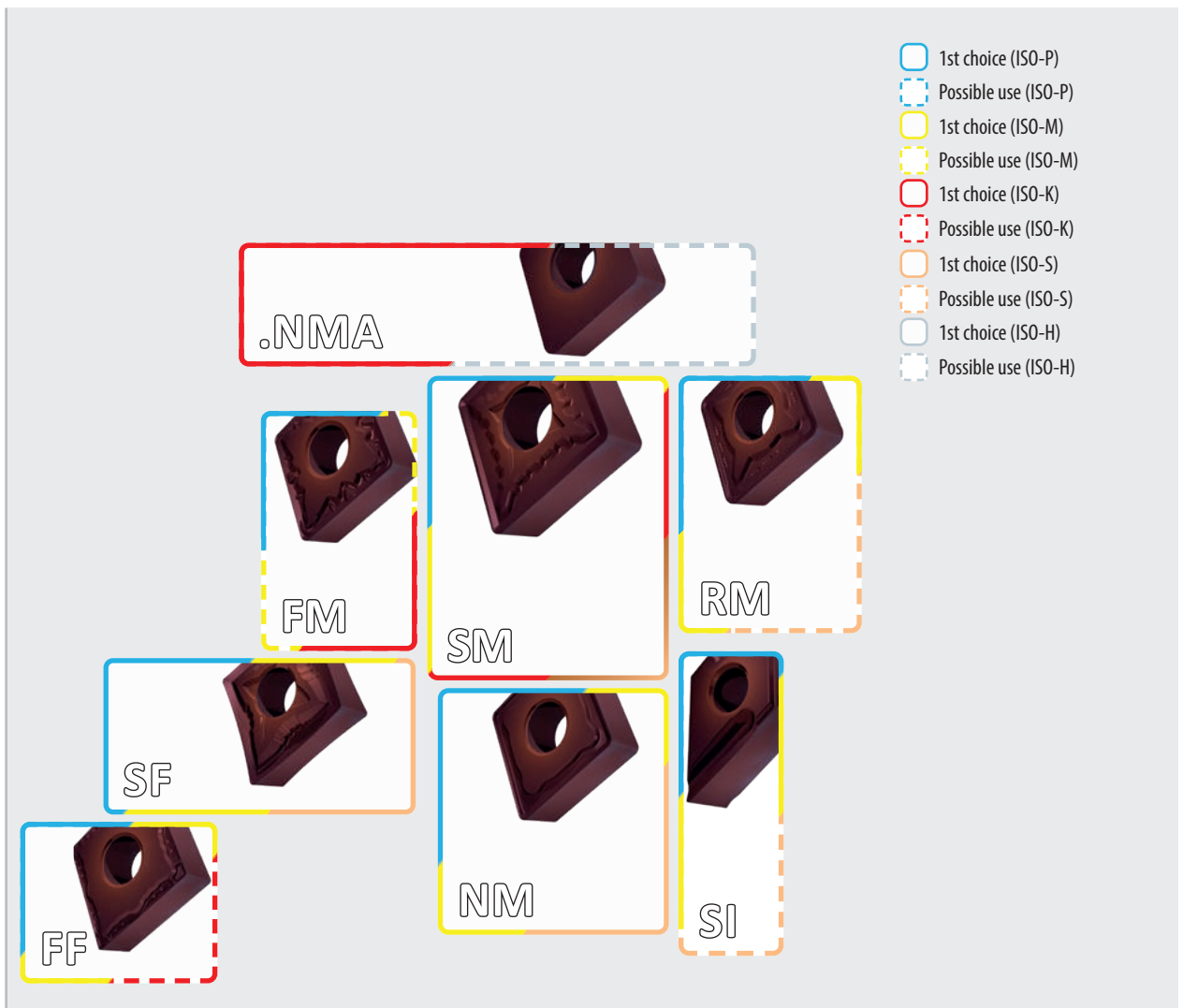

 Unstable working conditions

 Stable working conditions

 Thin-walled and slim workpieces

-  1st choice (ISO-P)
-  Possible use (ISO-P)
-  1st choice (ISO-M)
-  Possible use (ISO-M)
-  1st choice (ISO-K)
-  Possible use (ISO-K)
-  1st choice (ISO-S)
-  Possible use (ISO-S)
-  1st choice (ISO-H)
-  Possible use (ISO-H)

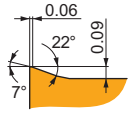
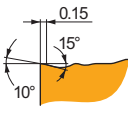
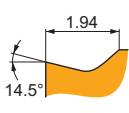
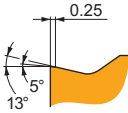
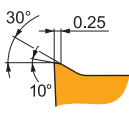
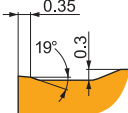

					
 f	0.05 – 0.2 mm/rev		0.2 – 0.4 mm/rev	0.4 – 1.0 mm/rev	> 1.0 mm/rev
 a_p	0.05 – 2 mm		2 – 4 mm	4 – 10 mm	> 10 mm

FF		Highly positive design for fine finish continuous cuts, suitable for steels and stainless steels, potentially cast irons.	FM		Positive design for fine moderately interrupted cuts to semi-rough continuous cuts, suitable for steels, cast irons, potentially stainless steels and super alloys.
SF		Positive design for fine finish continuous cuts, suitable for super alloys, stainless steels, steels, potentially cast irons, hard and non-ferrous materials.	SM		Versatile design for light interrupted cuts up to semi-rough continuous cuts, suitable for stainless steels, super alloys, steels and cast irons, potentially non-ferrous and hard materials.
NM		Highly positive design for semi-finish up to semi-rough continuous cuts, suitable for stainless steels, soft steels and super alloys, potentially non-ferrous materials.	RM		Versatile design stable T-land for medium interrupted cuts up to rough continuous cuts, suitable for steels, stainless steels and cast irons, potentially super alloys.



FF2







FF2 chip breaker is sharp and the first choice for fine-finishing of Steels. It features slightly positive rake angle without T-land. It's also suitable for Cast irons.

PRAMET

VCGT

	IC	D1	L	S
	(mm)	(mm)	(mm)	(mm)
0702	3.970	2.20	6.90	2.38



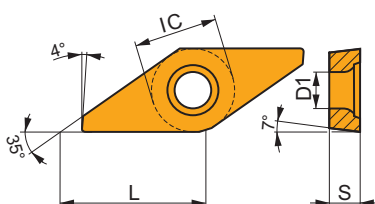
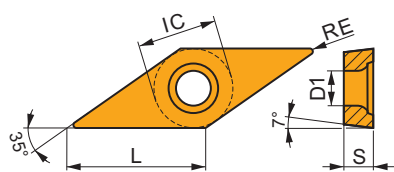

VCGX



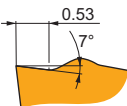

	IC	D1	L	S
	(mm)	(mm)	(mm)	(mm)
1303	7.940	3.40	13.80	3.18





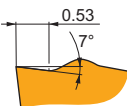

Suitability and starting values for cutting speed (vc), feed (f) and depth of cut (ap). Refer to our Machining Calculator app for further calculations.

Product	Interrupted/ Continuous cut	RE (mm)	P			M			K			N			S			H		
			vc (m/min)	f (mm/rev)	ap (mm)	vc (m/min)	f (mm/rev)	ap (mm)	vc (m/min)	f (mm/rev)	ap (mm)	vc (m/min)	f (mm/rev)	ap (mm)	vc (m/min)	f (mm/rev)	ap (mm)	vc (m/min)	f (mm/rev)	ap (mm)

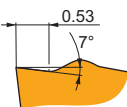
		  	● 0.2	■ 185	■ 0.05	■ 0.8	■ -	■ -	■ -	■ 165	■ 0.05	■ 0.8	■ -	■ -	■ -	■ -	■ -	■ -	■ -	■ -
				■ 155	■ 0.12	■ 0.8	■ -	■ -	■ -	■ 140	■ 0.12	■ 0.8	■ -	■ -	■ -	■ -	■ -	■ -	■ -	■ -
VCGT 070202E-FF2:T8415																				
VCGT 070204E-FF2:T8415			● 0.4	■ 155	■ 0.12	■ 0.8	■ -	■ -	■ -	■ 140	■ 0.12	■ 0.8	■ -	■ -	■ -	■ -	■ -	■ -	■ -	■ -

		  	● 0.0	■ 180	■ 0.05	■ 1.0	■ -	■ -	■ -	■ 160	■ 0.05	■ 1.0	■ -	■ -	■ -	■ -	■ -	■ -	■ -	■ -
				■ 180	■ 0.05	■ 1.0	■ -	■ -	■ -	■ 160	■ 0.05	■ 1.0	■ -	■ -	■ -	■ -	■ -	■ -	■ -	■ -
VCGX 130300FR-FF2:T8415																				
VCGX 130301FR-FF2:T8415			● 0.1	■ 180	■ 0.05	■ 1.0	■ -	■ -	■ -	■ 160	■ 0.05	■ 1.0	■ -	■ -	■ -	■ -	■ -	■ -	■ -	■ -

		  	● 0.0	■ 180	■ 0.05	■ 1.0	■ -	■ -	■ -	■ 160	■ 0.05	■ 1.0	■ -	■ -	■ -	■ -	■ -	■ -	■ -	■ -
				■ 180	■ 0.05	■ 1.0	■ -	■ -	■ -	■ 160	■ 0.05	■ 1.0	■ -	■ -	■ -	■ -	■ -	■ -	■ -	■ -
VCGX 130300FL-FF2:T8415																				
VCGX 130301FL-FF2:T8415			● 0.1	■ 180	■ 0.05	■ 1.0	■ -	■ -	■ -	■ 160	■ 0.05	■ 1.0	■ -	■ -	■ -	■ -	■ -	■ -	■ -	■ -



SF3

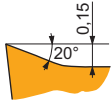

SF3 chip breaker is sharp and the first choice for fine-finishing of Stainless steels and Super-alloys. It features highly positive rake angle without T-land. It's also suitable for Non-ferrous alloys, and conditionally for Steels, Cast irons and Hard materials.



CCGT

	IC (mm)	D1 (mm)	L (mm)	S (mm)
0602-SF3	6.350	2.80	6.40	2.58
0803-SF3	7.940	3.40	8.10	3.43
09T3-SF3	9.525	4.40	9.70	4.22
1204-SF3	12.700	5.50	12.90	5.01

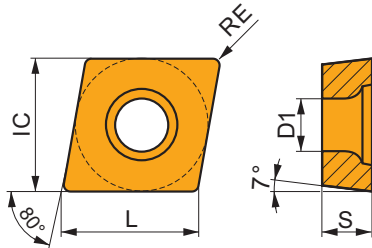

DCGT

	IC (mm)	D1 (mm)	L (mm)	S (mm)
0702-SF3	6.350	2.80	7.80	2.58
11T3-SF3	9.525	4.40	11.60	4.22

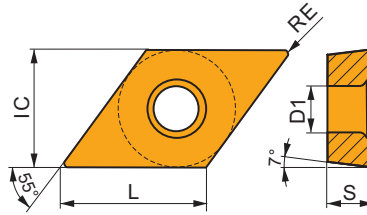

ECGT

	IC (mm)	D1 (mm)	L (mm)	S (mm)
0602-SF3	6.350	2.80	6.50	2.58
0803-SF3	7.940	3.40	8.20	3.43

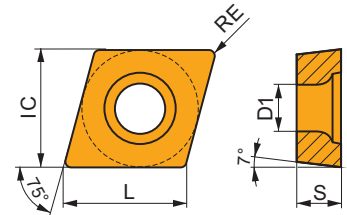

SCGT

	IC (mm)	D1 (mm)	L (mm)	S (mm)
09T3-SF3	9.525	4.40	9.53	4.22

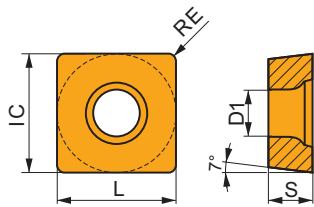

TCGT

	IC (mm)	D1 (mm)	L (mm)	S (mm)
1102-SF3	6.350	2.80	11.00	2.58
16T3-SF3	9.525	4.40	16.50	4.22

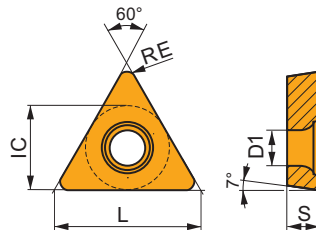

VCGT

	IC (mm)	D1 (mm)	L (mm)	S (mm)
0702	3.970	2.20	6.90	2.38
1102-SF3	6.350	2.80	11.10	2.58
1103-SF3	6.350	2.80	11.10	3.43
1303-SF3	7.940	3.40	13.80	3.43
1604-SF3	9.525	4.40	16.60	5.01

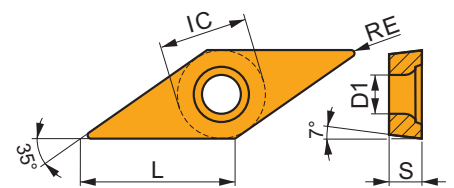

Suitability and starting values for cutting speed (vc), feed (f) and depth of cut (ap). Refer to our Machining Calculator app for further calculations.

Product	Interrupted/ Continuous cut	RE (mm)	P			M			K			N			S			H		
			vc (m/min)	f (mm/rev)	ap (mm)	vc (m/min)	f (mm/rev)	ap (mm)	vc (m/min)	f (mm/rev)	ap (mm)	vc (m/min)	f (mm/rev)	ap (mm)	vc (m/min)	f (mm/rev)	ap (mm)	vc (m/min)	f (mm/rev)	ap (mm)

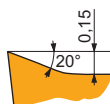
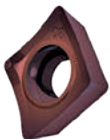

SF3 chip breaker is sharp and the first choice for fine-finishing of Stainless steels and Super-alloys. It features highly positive rake angle without T-land. It's also suitable for Non-ferrous alloys, and conditionally for Steels, Cast irons and Hard materials.

CCGT 060202E-SF3:T8415	●	0.2	270	0.05	0.8	140	0.04	0.8	245	0.05	0.8	675	0.06	0.8	60	0.04	0.6	45	0.05	0.2
CCGT 060204E-SF3:T8415	●	0.4	230	0.10	0.8	120	0.09	0.8	210	0.10	0.8	585	0.12	0.8	50	0.07	0.6	40	0.07	0.3
CCGT 080302E-SF3:T8415	●	0.2	270	0.05	0.8	140	0.04	0.8	245	0.05	0.8	675	0.06	0.8	60	0.04	0.6	45	0.05	0.2
CCGT 080304E-SF3:T8415	●	0.4	225	0.10	1.0	115	0.09	1.0	205	0.10	1.0	570	0.12	1.0	50	0.07	0.8	35	0.10	0.3
CCGT 09T302E-SF3:T8415	●	0.2	270	0.05	0.8	140	0.04	0.8	245	0.05	0.8	675	0.06	0.8	60	0.04	0.6	45	0.05	0.2
CCGT 09T304E-SF3:T8415	●	0.4	225	0.10	1.0	115	0.09	1.0	205	0.10	1.0	570	0.12	1.0	50	0.07	0.8	35	0.05	0.3
CCGT 09T308E-SF3:T8415	●	0.8	275	0.10	1.0	140	0.09	1.0	250	0.10	1.0	690	0.12	1.0	60	0.08	0.8	45	0.08	0.7
CCGT 120404E-SF3:T8415	●	0.4	225	0.10	1.0	115	0.09	1.0	205	0.10	1.0	570	0.12	1.0	50	0.07	0.8	35	0.07	0.3
CCGT 120408E-SF3:T8415	●	0.8	255	0.12	1.0	135	0.12	1.0	230	0.12	1.0	645	0.14	1.0	55	0.11	0.8	45	0.10	0.7

● Stable working conditions ● Unstable working conditions ● Heavy working conditions ■ Primary use ▣ Possible use



Suitability and starting values for cutting speed (vc), feed (f) and depth of cut (ap). Refer to our Machining Calculator app for further calculations.

Product	Interrupted/ Continuous cut	RE (mm)	P			M			K			N			S			H		
			vc (m/min)	f (mm/rev)	ap (mm)	vc (m/min)	f (mm/rev)	ap (mm)	vc (m/min)	f (mm/rev)	ap (mm)	vc (m/min)	f (mm/rev)	ap (mm)	vc (m/min)	f (mm/rev)	ap (mm)	vc (m/min)	f (mm/rev)	ap (mm)

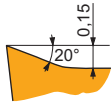

SF3 chip breaker is sharp and the first choice for fine-finishing of Stainless steels and Super-alloys. It features highly positive rake angle without T-land. It's also suitable for Non-ferrous alloys, and conditionally for Steels, Cast irons and Hard materials.

DCGT 070202E-SF3:T8415	●	0.2	215	0.05	0.8	110	0.04	0.8	195	0.05	0.8	540	0.06	0.8	45	0.04	0.6	35	0.05	0.2
DCGT 070204E-SF3:T8415	●	0.4	185	0.10	0.8	95	0.09	0.8	165	0.10	0.8	465	0.12	0.8	40	0.07	0.6	30	0.07	0.3
DCGT 11T302E-SF3:T8415	●	0.2	215	0.05	0.8	110	0.04	0.8	195	0.05	0.8	540	0.06	0.8	45	0.04	0.6	35	0.05	0.2
DCGT 11T304E-SF3:T8415	●	0.4	185	0.10	0.8	95	0.09	0.8	165	0.10	0.8	465	0.12	0.8	40	0.07	0.6	30	0.07	0.3
DCGT 11T308E-SF3:T8415	●	0.8	220	0.10	0.8	115	0.09	0.8	200	0.10	0.8	555	0.12	0.8	50	0.08	0.6	35	0.08	0.7

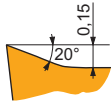
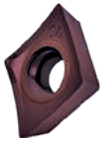

SF3 chip breaker is sharp and the first choice for fine-finishing of Stainless steels and Super-alloys. It features highly positive rake angle without T-land. It's also suitable for Non-ferrous alloys, and conditionally for Steels, Cast irons and Hard materials.

ECGT 060202E-SF3:T8415	●	0.2	240	0.05	0.8	125	0.04	0.8	215	0.05	0.8	600	0.06	0.8	55	0.04	0.6	40	0.05	0.2
ECGT 080304E-SF3:T8415	●	0.4	200	0.10	1.0	105	0.09	1.0	185	0.10	1.0	510	0.12	1.0	45	0.07	0.8	35	0.05	0.3

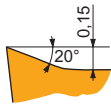
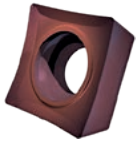

SF3 chip breaker is sharp and the first choice for fine-finishing of Stainless steels and Super-alloys. It features highly positive rake angle without T-land. It's also suitable for Non-ferrous alloys, and conditionally for Steels, Cast irons and Hard materials.

SCGT 09T304E-SF3:T8415	●	0.4	240	0.10	1.0	125	0.09	1.0	215	0.10	1.0	600	0.12	1.0	55	0.07	0.8	40	0.05	0.3
SCGT 09T308E-SF3:T8415	⊕	0.8	270	0.12	1.0	140	0.12	1.0	245	0.12	1.0	675	0.14	1.0	60	0.11	0.8	45	0.10	0.7

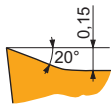
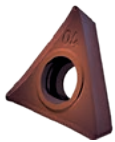

SF3 chip breaker is sharp and the first choice for fine-finishing of Stainless steels and Super-alloys. It features highly positive rake angle without T-land. It's also suitable for Non-ferrous alloys, and conditionally for Steels, Cast irons and Hard materials.

TCGT 110202E-SF3:T8415	●	0.2	225	0.05	0.8	115	0.04	0.8	205	0.05	0.8	570	0.06	0.8	50	0.04	0.6	35	0.05	0.2
TCGT 110204E-SF3:T8415	●	0.4	195	0.10	0.8	100	0.09	0.8	180	0.10	0.8	495	0.12	0.8	45	0.07	0.6	30	0.07	0.3
TCGT 16T304E-SF3:T8415	●	0.4	195	0.10	1.0	100	0.09	1.0	180	0.10	1.0	495	0.12	1.0	45	0.07	0.8	30	0.07	0.3
TCGT 16T308E-SF3:T8415	●	0.8	225	0.10	1.2	115	0.09	1.2	205	0.10	1.2	570	0.12	1.2	50	0.08	1.0	35	0.08	0.7
TCGT 16T312E-SF3:T8415	●	1.2	190	0.20	1.2	100	0.18	1.2	170	0.20	1.2	480	0.24	1.2	40	0.14	1.0	30	0.10	0.9

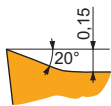

SF3 chip breaker is sharp and the first choice for fine-finishing of Stainless steels and Super-alloys. It features highly positive rake angle without T-land. It's also suitable for Non-ferrous alloys, and conditionally for Steels, Cast irons and Hard materials.

VCGT 070202E-SF3:T8415	●	0.2	185	0.05	0.8	95	0.04	0.8	165	0.05	0.8	465	0.06	0.8	40	0.04	0.6	30	0.05	0.2
VCGT 070204E-SF3:T8415	●	0.4	160	0.10	0.8	85	0.09	0.8	145	0.10	0.8	405	0.12	0.8	35	0.07	0.6	25	0.07	0.3
VCGT 110202E-SF3:T8415	●	0.2	185	0.05	0.8	95	0.04	0.8	165	0.05	0.8	465	0.06	0.8	40	0.04	0.6	30	0.05	0.2
VCGT 110204E-SF3:T8415	●	0.4	160	0.10	0.8	85	0.09	0.8	145	0.10	0.8	405	0.12	0.8	35	0.07	0.6	25	0.07	0.3
VCGT 110304E-SF3:T8415	●	0.4	160	0.10	0.8	85	0.09	0.8	145	0.10	0.8	405	0.12	0.8	35	0.07	0.6	25	0.07	0.3
VCGT 130302E-SF3:T8415	●	0.2	185	0.05	0.8	95	0.04	0.8	165	0.05	0.8	465	0.06	0.8	40	0.04	0.6	30	0.05	0.2
VCGT 130304E-SF3:T8415	●	0.4	160	0.10	1.0	85	0.09	1.0	145	0.10	1.0	405	0.12	1.0	35	0.07	0.8	25	0.07	0.3
VCGT 130308E-SF3:T8415	●	0.8	190	0.10	1.0	100	0.09	1.0	170	0.10	1.0	480	0.12	1.0	40	0.08	0.8	30	0.08	0.7
VCGT 160402E-SF3:T8415	●	0.2	185	0.05	0.8	95	0.04	0.8	165	0.05	0.8	465	0.06	0.8	40	0.04	0.6	30	0.05	0.2
VCGT 160404E-SF3:T8415	●	0.4	160	0.10	1.0	85	0.09	1.0	145	0.10	1.0	405	0.12	1.0	35	0.07	0.8	25	0.07	0.3
VCGT 160408E-SF3:T8415	●	0.8	185	0.10	1.2	95	0.09	1.2	165	0.10	1.2	465	0.12	1.2	40	0.08	1.0	30	0.08	0.7
VCGT 160412E-SF3:T8415	●	1.2	160	0.20	1.2	85	0.18	1.2	145	0.20	1.2	405	0.24	1.2	35	0.14	1.0	25	0.10	0.9

● Stable working conditions ⊕ Unstable working conditions ⊕ Heavy working conditions ■ Primary use ▣ Possible use



FM

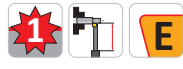
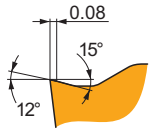

FM chip breaker is versatile and the first choice for finishing of Steels. It features positive rake angle and positive, narrow T-land. It's also suitable for Stainless steels, and conditionally for Cast irons and Non-ferrous alloys.



CCMT

	IC (mm)	D1 (mm)	L (mm)	S (mm)
0602	6.350	2.80	6.40	2.38
09T3	9.525	4.40	9.70	3.97
1204	12.700	5.50	12.90	4.76

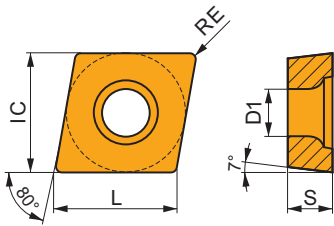

DCMT

	IC (mm)	D1 (mm)	L (mm)	S (mm)
0702	6.350	2.80	7.80	2.38
11T3	9.525	4.40	11.60	3.97

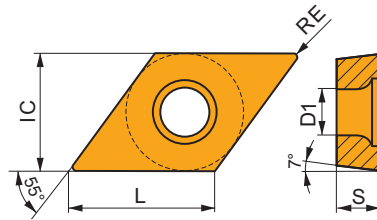

SCMT

	IC (mm)	D1 (mm)	L (mm)	S (mm)
09T3	9.525	4.40	9.53	3.97
1204	12.700	5.50	12.70	4.76

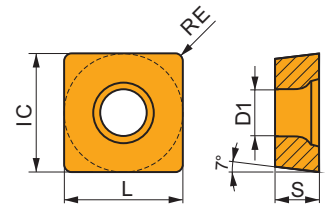

TCMT

	IC (mm)	D1 (mm)	L (mm)	S (mm)
1102	6.350	2.80	11.00	2.38
16T3	9.525	4.40	16.50	3.97

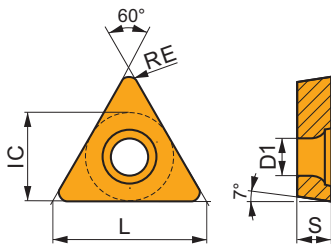

VBMT

	IC (mm)	D1 (mm)	L (mm)	S (mm)
1103	6.350	2.80	11.10	3.18
1604	9.525	4.40	16.60	4.76

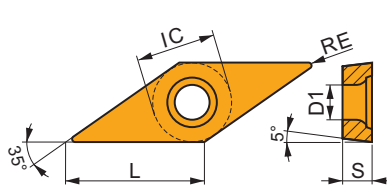

WCMT

	IC (mm)	D1 (mm)	L (mm)	S (mm)
06T3	9.525	4.40	6.50	3.97

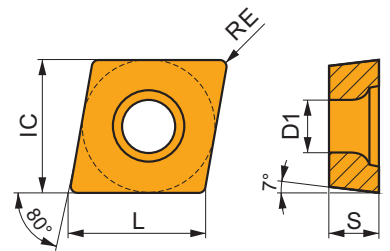

Suitability and starting values for cutting speed (vc), feed (f) and depth of cut (ap). Refer to our Machining Calculator app for further calculations.

Product	Interrupted/ Continuous cut	RE (mm)	P			M			K			N			S			H		
			vc (m/min)	f (mm/rev)	ap (mm)	vc (m/min)	f (mm/rev)	ap (mm)	vc (m/min)	f (mm/rev)	ap (mm)	vc (m/min)	f (mm/rev)	ap (mm)	vc (m/min)	f (mm/rev)	ap (mm)	vc (m/min)	f (mm/rev)	ap (mm)

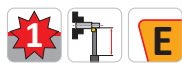
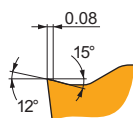
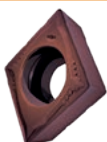

FM chip breaker is versatile and the first choice for finishing of Steels. It features positive rake angle and positive, narrow T-land. It's also suitable for Stainless steels, and conditionally for Cast irons and Non-ferrous alloys.

CCMT 060202E-FM:T8415	●	0.2	■	240	0.10	1.0	■	125	0.09	1.0	■	215	0.10	1.0	■	600	0.12	1.0	-	-	-	-	-	-
CCMT 060204E-FM:T8415	●	0.4	■	225	0.15	1.0	■	115	0.14	1.0	■	205	0.15	1.0	■	570	0.18	1.0	-	-	-	-	-	-
CCMT 09T302E-FM:T8415	●	0.2	■	230	0.10	1.2	■	120	0.09	1.2	■	210	0.10	1.2	■	585	0.12	1.2	-	-	-	-	-	-
CCMT 09T304E-FM:T8415	●	0.4	■	220	0.15	1.2	■	115	0.14	1.2	■	200	0.15	1.2	■	555	0.18	1.2	-	-	-	-	-	-
CCMT 09T308E-FM:T8415	●	0.8	■	240	0.20	1.2	■	125	0.18	1.2	■	215	0.20	1.2	■	600	0.24	1.2	-	-	-	-	-	-
CCMT 120404E-FM:T8415	●	0.4	■	210	0.15	1.7	■	110	0.14	1.7	■	190	0.15	1.7	■	525	0.18	1.7	-	-	-	-	-	-
CCMT 120408E-FM:T8415	●	0.8	■	230	0.20	1.7	■	120	0.18	1.7	■	210	0.20	1.7	■	585	0.24	1.7	-	-	-	-	-	-

● Stable working conditions ● Unstable working conditions ⚡ Heavy working conditions ■ Primary use ▣ Possible use



Suitability and starting values for cutting speed (vc), feed (f) and depth of cut (ap). Refer to our Machining Calculator app for further calculations.

Product	Interrupted/ Continuous cut	RE (mm)	P			M			K			N			S			H		
			vc (m/min)	f (mm/rev)	ap (mm)	vc (m/min)	f (mm/rev)	ap (mm)	vc (m/min)	f (mm/rev)	ap (mm)	vc (m/min)	f (mm/rev)	ap (mm)	vc (m/min)	f (mm/rev)	ap (mm)	vc (m/min)	f (mm/rev)	ap (mm)

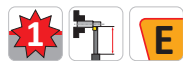
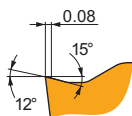

FM chip breaker is versatile and the first choice for finishing of Steels. It features positive rake angle and positive, narrow T-land. It's also suitable for Stainless steels, and conditionally for Cast irons and Non-ferrous alloys.

DCMT 070202E-FM:T8415	●	0.2	190	0.10	0.8	100	0.09	0.8	170	0.10	0.8	480	0.12	0.8	-	-	-	-	-	-
DCMT 070204E-FM:T8415	●	0.4	190	0.12	0.8	100	0.11	0.8	170	0.12	0.8	480	0.14	0.8	-	-	-	-	-	-
DCMT 11T302E-FM:T8415	●	0.2	190	0.10	0.8	100	0.09	0.8	170	0.10	0.8	480	0.12	0.8	-	-	-	-	-	-
DCMT 11T304E-FM:T8415	●	0.4	190	0.12	0.8	100	0.11	0.8	170	0.12	0.8	480	0.14	0.8	-	-	-	-	-	-
DCMT 11T308E-FM:T8415	●	0.8	210	0.17	0.8	110	0.15	0.8	190	0.17	0.8	525	0.20	0.8	-	-	-	-	-	-

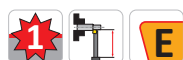
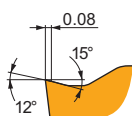
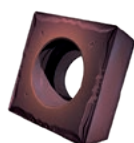

FM chip breaker is versatile and the first choice for finishing of Steels. It features positive rake angle and positive, narrow T-land. It's also suitable for Stainless steels, and conditionally for Cast irons and Non-ferrous alloys.

SCMT 09T304E-FM:T8415	●	0.4	230	0.15	1.2	120	0.14	1.2	210	0.15	1.2	585	0.18	1.2	-	-	-	-	-	-
SCMT 09T308E-FM:T8415	●	0.8	250	0.20	1.2	130	0.18	1.2	225	0.20	1.2	630	0.24	1.2	-	-	-	-	-	-
SCMT 120404E-FM:T8415	●	0.4	225	0.15	1.6	115	0.14	1.6	205	0.15	1.6	570	0.18	1.6	-	-	-	-	-	-
SCMT 120408E-FM:T8415	●	0.8	245	0.20	1.6	125	0.18	1.6	220	0.20	1.6	615	0.24	1.6	-	-	-	-	-	-

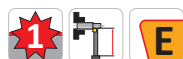
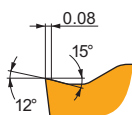
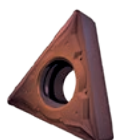

FM chip breaker is versatile and the first choice for finishing of Steels. It features positive rake angle and positive, narrow T-land. It's also suitable for Stainless steels, and conditionally for Cast irons and Non-ferrous alloys.

TCMT 110202E-FM:T8415	●	0.2	200	0.10	0.8	105	0.09	0.8	185	0.10	0.8	510	0.12	0.8	-	-	-	-	-	-
TCMT 110204E-FM:T8415	●	0.4	210	0.12	0.8	110	0.11	0.8	190	0.12	0.8	525	0.14	0.8	-	-	-	-	-	-
TCMT 16T304E-FM:T8415	●	0.4	190	0.12	1.7	100	0.11	1.7	170	0.12	1.7	480	0.14	1.7	-	-	-	-	-	-
TCMT 16T308E-FM:T8415	●	0.8	210	0.17	1.7	110	0.15	1.7	190	0.17	1.7	525	0.20	1.7	-	-	-	-	-	-

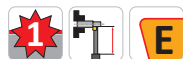
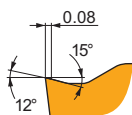

FM chip breaker is versatile and the first choice for finishing of Steels. It features positive rake angle and positive, narrow T-land. It's also suitable for Stainless steels, and conditionally for Cast irons and Non-ferrous alloys.

VBMT 110302E-FM:T8415	●	0.2	180	0.10	0.8	90	0.09	0.8	160	0.10	0.8	450	0.12	0.8	-	-	-	-	-	-
VBMT 110304E-FM:T8415	●	0.4	180	0.12	0.8	90	0.11	0.8	160	0.12	0.8	450	0.14	0.8	-	-	-	-	-	-
VBMT 160404E-FM:T8415	●	0.4	170	0.12	1.2	90	0.11	1.2	155	0.12	1.2	435	0.14	1.2	-	-	-	-	-	-
VBMT 160408E-FM:T8415	●	0.8	185	0.17	1.2	95	0.15	1.2	165	0.17	1.2	465	0.20	1.2	-	-	-	-	-	-

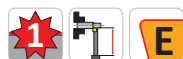
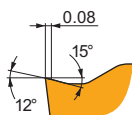
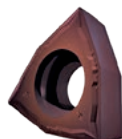

FM chip breaker is versatile and the first choice for finishing of Steels. It features positive rake angle and positive, narrow T-land. It's also suitable for Stainless steels, and conditionally for Cast irons and Non-ferrous alloys.

WCMT 06T304E-FM:T8415	●	0.4	220	0.15	1.2	115	0.14	1.2	200	0.15	1.2	555	0.18	1.2	-	-	-	-	-	-
WCMT 06T308E-FM:T8415	●	0.8	240	0.20	1.2	125	0.18	1.2	215	0.20	1.2	600	0.24	1.2	-	-	-	-	-	-



NF2

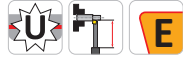
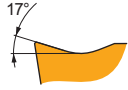

NF2 chip breaker is sharp and the first choice for finishing of Stainless steels. It features positive rake angle without T-land. It's also suitable for Super-alloys, and conditionally for Steels, Cast irons and Non-ferrous alloys.



CCMT

VCGT

	IC (mm)	D1 (mm)	L (mm)	S (mm)
0602	6.350	2.80	6.40	2.38
09T3	9.525	4.40	9.70	3.97

	IC (mm)	D1 (mm)	L (mm)	S (mm)
1303	7.940	3.40	13.80	3.18

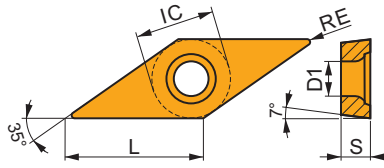
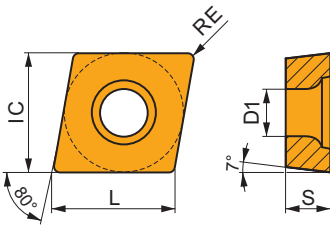

Suitability and starting values for cutting speed (vc), feed (f) and depth of cut (ap). Refer to our Machining Calculator app for further calculations.

Product	Interrupted/ Continuous cut	RE (mm)	P			M			K			N			S			H		
			vc (m/min)	f (mm/rev)	ap (mm)	vc (m/min)	f (mm/rev)	ap (mm)	vc (m/min)	f (mm/rev)	ap (mm)	vc (m/min)	f (mm/rev)	ap (mm)	vc (m/min)	f (mm/rev)	ap (mm)	vc (m/min)	f (mm/rev)	ap (mm)

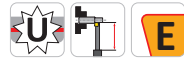
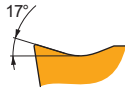
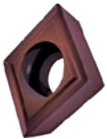

NF2 chip breaker is sharp and the first choice for finishing of Stainless steels. It features positive rake angle without T-land. It's also suitable for Super-alloys, and conditionally for Steels, Cast irons and Non-ferrous alloys.

CCMT 060202E-NF2:T8415	●	0.2	220	0.10	0.8	115	0.09	0.8	200	0.10	0.8	555	0.12	0.8	50	0.08	0.6	-	-	-
CCMT 060204E-NF2:T8415	●	0.4	220	0.12	0.8	115	0.11	0.8	200	0.12	0.8	555	0.14	0.8	50	0.11	0.6	-	-	-
CCMT 09T304E-NF2:T8415	●	0.4	215	0.12	1.2	110	0.11	1.2	195	0.12	1.2	540	0.14	1.2	45	0.11	1.0	-	-	-
CCMT 09T308E-NF2:T8415	●	0.8	245	0.14	1.2	125	0.13	1.2	220	0.14	1.2	615	0.17	1.2	55	0.13	1.0	-	-	-

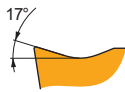

NF2 chip breaker is sharp and the first choice for finishing of Stainless steels. It features positive rake angle without T-land. It's also suitable for Super-alloys, and conditionally for Steels, Cast irons and Non-ferrous alloys.

VCGT 130302E-NF2:T8415	●	0.2	160	0.07	1.0	85	0.06	1.0	145	0.07	1.0	405	0.08	1.0	35	0.06	0.8	-	-	-
VCGT 130304E-NF2:T8415	●	0.4	150	0.12	1.0	75	0.11	1.0	135	0.12	1.0	375	0.14	1.0	30	0.11	0.8	-	-	-
VCGT 130308E-NF2:T8415	●	0.8	160	0.17	1.0	85	0.15	1.0	145	0.17	1.0	405	0.20	1.0	35	0.12	0.8	-	-	-



UR

UR chip breaker is versatile and the first choice for finishing of Cast irons. It features positive rake angle without T-land. It's also suitable for Steels, and conditionally for Stainless steels.

PRAMET

CCMT

	IC (mm)	D1 (mm)	L (mm)	S (mm)
0602	6.350	2.80	6.40	2.38
09T3	9.525	4.40	9.70	3.97

DCMT

	IC (mm)	D1 (mm)	L (mm)	S (mm)
0702	6.350	2.80	7.80	2.38
11T3	9.525	4.40	11.60	3.97

RCMT

	INSD (mm)	D1 (mm)	S (mm)
0602	6.000	2.80	2.38
0803	8.000	3.40	3.18
10T3	10.000	4.40	3.97
1204	12.000	4.40	4.76

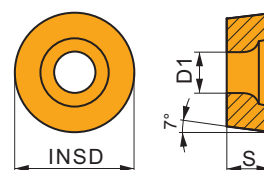
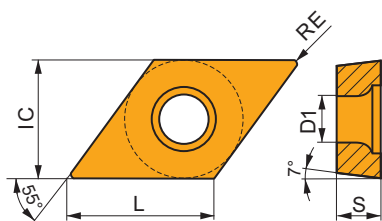
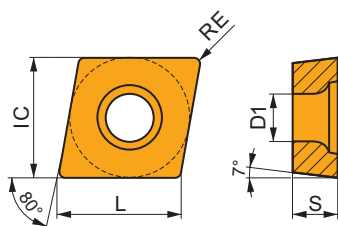

Suitability and starting values for cutting speed (vc), feed (f) and depth of cut (ap). Refer to our Machining Calculator app for further calculations.

Product	Interrupted/ Continuous cut	RE (mm)	P			M			K			N			S			H		
			vc	f	ap	vc	f	ap	vc	f	ap	vc	f	ap	vc	f	ap	vc	f	ap
			(m/min)	(mm/rev)	(mm)	(m/min)	(mm/rev)	(mm)	(m/min)	(mm/rev)	(mm)	(m/min)	(mm/rev)	(mm)	(m/min)	(mm/rev)	(mm)	(m/min)	(mm/rev)	(mm)

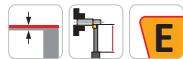
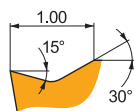
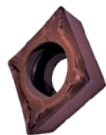

UR chip breaker is versatile and the first choice for finishing of Cast irons. It features positive rake angle without T-land. It's also suitable for Steels, and conditionally for Stainless steels.

CCMT 060202E-UR:T8415	●	0.2	■	210	0.10	0.8	☑	110	0.09	0.8	■	190	0.10	0.8	■	—	—	—	■	—	—	—
CCMT 060204E-UR:T8415	●	0.4	■	190	0.15	1.0	☑	100	0.14	1.0	■	170	0.15	1.0	■	—	—	—	■	—	—	—
CCMT 09T302E-UR:T8415	●	0.2	■	200	0.10	1.0	☑	105	0.09	1.0	■	185	0.10	1.0	■	—	—	—	■	—	—	—
CCMT 09T304E-UR:T8415	●	0.4	■	190	0.15	1.2	☑	100	0.14	1.2	■	170	0.15	1.2	■	—	—	—	■	—	—	—
CCMT 09T308E-UR:T8415	●	0.8	■	200	0.20	1.2	☑	105	0.18	1.2	■	185	0.20	1.2	■	—	—	—	■	—	—	—

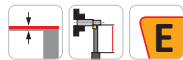
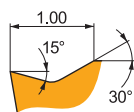

UR chip breaker is versatile and the first choice for finishing of Cast irons. It features positive rake angle without T-land. It's also suitable for Steels, and conditionally for Stainless steels.

DCMT 070202E-UR:T8415	●	0.2	■	165	0.10	0.8	☑	85	0.09	0.8	■	150	0.10	0.8	■	—	—	—	■	—	—	—
DCMT 070204E-UR:T8415	●	0.4	■	165	0.12	0.8	☑	85	0.11	0.8	■	150	0.12	0.8	■	—	—	—	■	—	—	—
DCMT 11T304E-UR:T8415	●	0.4	■	165	0.12	0.8	☑	85	0.11	0.8	■	150	0.12	0.8	■	—	—	—	■	—	—	—
DCMT 11T308E-UR:T8415	●	0.8	■	180	0.17	0.8	☑	90	0.15	0.8	■	160	0.17	0.8	■	—	—	—	■	—	—	—

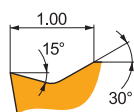

UR chip breaker is versatile and the first choice for finishing of Cast irons. It features positive rake angle without T-land. It's also suitable for Steels, and conditionally for Stainless steels.

RCMT 0602MOE-UR:T8415	⚙	—	■	220	0.40	1.2	☑	115	0.36	1.2	■	200	0.40	1.2	■	—	—	—	■	—	—	—
RCMT 0803MOE-UR:T8415	⚙	—	■	200	0.45	1.6	☑	105	0.41	1.6	■	185	0.45	1.6	■	—	—	—	■	—	—	—
RCMT 10T3MOE-UR:T8415	⚙	—	■	200	0.50	1.4	☑	105	0.45	1.4	■	185	0.50	1.4	■	—	—	—	■	—	—	—
RCMT 1204MOE-UR:T8415	⚙	—	■	190	0.55	1.8	☑	100	0.49	1.8	■	170	0.55	1.8	■	—	—	—	■	—	—	—

● Stable working conditions ⚙ Unstable working conditions ⚙ Heavy working conditions ■ Primary use ☑ Possible use



SI

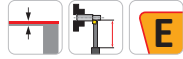

SI chip breaker is sharp and the first choice for medium machining of Stainless steels. It features highly positive rake angle without T-land. It's also suitable for Steels and Super-alloys, and conditionally for Cast irons.



CCGT

TCGT

	IC (mm)	D1 (mm)	L (mm)	S (mm)
0602	6.350	2.80	6.40	2.38
09T3	9.525	4.40	9.70	3.97

	IC (mm)	D1 (mm)	L (mm)	S (mm)
1102	6.350	2.80	11.00	2.38

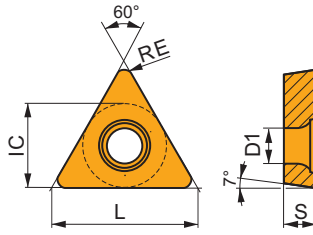
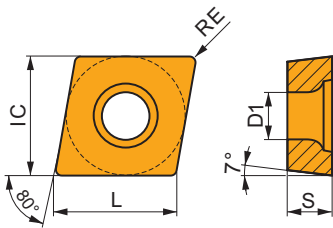

Suitability and starting values for cutting speed (vc), feed (f) and depth of cut (ap). Refer to our Machining Calculator app for further calculations.

Product	Interrupted/ Continuous cut	RE (mm)	P			M			K			N			S			H		
			vc (m/min)	f (mm/rev)	ap (mm)	vc (m/min)	f (mm/rev)	ap (mm)	vc (m/min)	f (mm/rev)	ap (mm)	vc (m/min)	f (mm/rev)	ap (mm)	vc (m/min)	f (mm/rev)	ap (mm)			

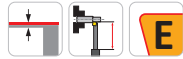
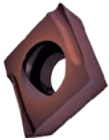

SI chip breaker is sharp and the first choice for medium machining of Stainless steels. It features highly positive rake angle without T-land. It's also suitable for Steels and Super-alloys, and conditionally for Cast irons.

CCGT 060204EL-SI:T8415	●	0.4	■	275	0.12	0.8	■	140	0.11	0.8	▣	250	0.12	0.8	■	60	0.10	0.6	■	-	-	-
CCGT 09T304EL-SI:T8415	●	0.4	■	250	0.17	0.8	■	130	0.15	0.8	▣	225	0.17	0.8	■	55	0.15	0.6	■	-	-	-

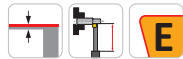
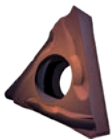

SI chip breaker is sharp and the first choice for medium machining of Stainless steels. It features highly positive rake angle without T-land. It's also suitable for Steels and Super-alloys, and conditionally for Cast irons.

TCGT 110202EL-SI:T8415	●	0.2	■	230	0.10	0.8	■	120	0.09	0.8	▣	210	0.10	0.8	■	50	0.08	0.6	■	-	-	-
TCGT 110204EL-SI:T8415	●	0.4	■	230	0.12	0.8	■	120	0.11	0.8	▣	210	0.12	0.8	■	50	0.10	0.6	■	-	-	-



CMW

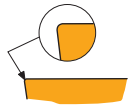

...W flat insert is designed for medium machining of Cast irons. It features neutral rake angle without T-land. It's also conditionally suitable for Hard materials.



CCMW

	IC (mm)	D1 (mm)	L (mm)	S (mm)
0602	6.350	2.80	6.40	2.38
09T3	9.525	4.40	9.70	3.97

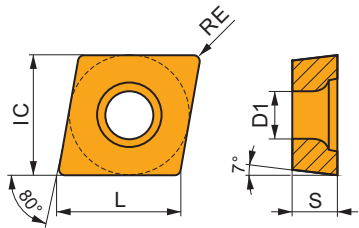

DCMW

	IC (mm)	D1 (mm)	L (mm)	S (mm)
0702	6.350	2.80	7.80	2.38
11T3	9.525	4.40	11.60	3.97

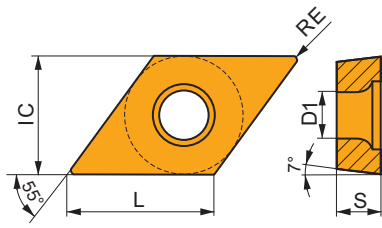

TCMW

	IC (mm)	D1 (mm)	L (mm)	S (mm)
16T3	9.525	4.40	16.50	3.97

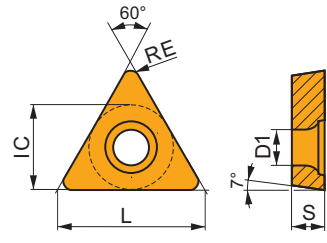

WCMW

	IC (mm)	D1 (mm)	L (mm)	S (mm)
1103	6.350	2.80	11.10	3.18
1604	9.525	4.40	16.60	4.76

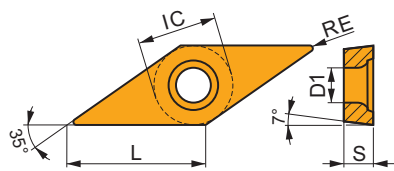

Suitability and starting values for cutting speed (vc), feed (f) and depth of cut (ap). Refer to our Machining Calculator app for further calculations.

Product	Interrupted/ Continuous cut	RE (mm)	P			M			K			N			S			H		
			vc (m/min)	f (mm/rev)	ap (mm)	vc (m/min)	f (mm/rev)	ap (mm)	vc (m/min)	f (mm/rev)	ap (mm)	vc (m/min)	f (mm/rev)	ap (mm)	vc (m/min)	f (mm/rev)	ap (mm)	vc (m/min)	f (mm/rev)	ap (mm)

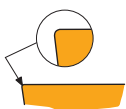
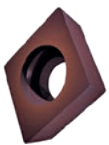

...W flat insert is designed for medium machining of Cast irons. It features neutral rake angle without T-land. It's also conditionally suitable for Hard materials.

CCMW 060204:T8415	●	0.4	-	-	-	-	-	-	■	145	0.10	2.0	-	-	-	-	-	-	▣	25	0.10	0.3
CCMW 09T304:T8415	●	0.4	-	-	-	-	-	-	■	135	0.10	3.0	-	-	-	-	-	-	▣	25	0.10	0.3
CCMW 09T308:T8415	⊕	0.8	-	-	-	-	-	-	■	135	0.20	3.0	-	-	-	-	-	-	▣	25	0.11	0.7

● Stable working conditions ⊕ Unstable working conditions ⊕ Heavy working conditions ■ Primary use ▣ Possible use



Suitability and starting values for cutting speed (vc), feed (f) and depth of cut (ap). Refer to our Machining Calculator app for further calculations.

Product	Interrupted/ Continuous cut	RE (mm)	P			M			K			N			S			H		
			vc	f	ap	vc	f	ap	vc	f	ap	vc	f	ap	vc	f	ap	vc	f	ap
			(m/min)	(mm/rev)	(mm)	(m/min)	(mm/rev)	(mm)	(m/min)	(mm/rev)	(mm)	(m/min)	(mm/rev)	(mm)	(m/min)	(mm/rev)	(mm)	(m/min)	(mm/rev)	(mm)

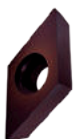

...W flat insert is designed for medium machining of Cast irons. It features neutral rake angle without T-land. It's also conditionally suitable for Hard materials.

DCMW 070204:T8415	●	0.4	-	-	-	-	-	-	■	125	0.10	0.8	-	-	-	-	-	-	☑	20	0.10	0.3
DCMW 11T304:T8415	●	0.4	-	-	-	-	-	-	■	120	0.10	1.2	-	-	-	-	-	-	☑	20	0.10	0.3
DCMW 11T308:T8415	●	0.8	-	-	-	-	-	-	■	125	0.18	1.2	-	-	-	-	-	-	☑	20	0.11	0.7

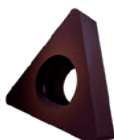

...W flat insert is designed for medium machining of Cast irons. It features neutral rake angle without T-land. It's also conditionally suitable for Hard materials.

TCMW 16T308:T8415	⚙	0.8	-	-	-	-	-	-	■	125	0.18	1.5	-	-	-	-	-	-	☑	20	0.11	0.7
-------------------	---	-----	---	---	---	---	---	---	---	-----	------	-----	---	---	---	---	---	---	---	----	------	-----



...W flat insert is designed for medium machining of Cast irons. It features neutral rake angle without T-land. It's also conditionally suitable for Hard materials.

VCMW 110304:T8415	●	0.4	-	-	-	-	-	-	■	105	0.10	1.2	-	-	-	-	-	-	☑	20	0.10	0.3
VCMW 160404:T8415	●	0.4	-	-	-	-	-	-	■	100	0.10	1.5	-	-	-	-	-	-	☑	15	0.10	0.3
VCMW 160408:T8415	●	0.8	-	-	-	-	-	-	■	100	0.18	1.5	-	-	-	-	-	-	☑	15	0.11	0.7



RM3

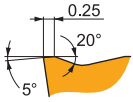

RM3 chip breaker is robust and designed for roughing of Steels and Cast irons. It features positive rake angle and negative, wide T-land. It's also conditionally suitable for Stainless steels and Hard materials.



TCMT

	IC (mm)	D1 (mm)	L (mm)	S (mm)
16T3	9.525	4.40	16.50	3.97

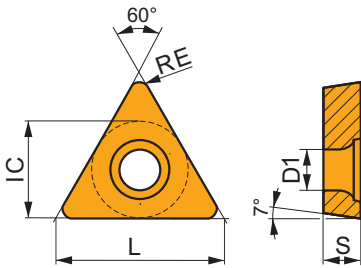

Suitability and starting values for cutting speed (vc), feed (f) and depth of cut (ap). Refer to our Machining Calculator app for further calculations.

Product	Interrupted/ Continuous cut	RE (mm)	P			M			K			N			S			H		
			vc (m/min)	f (mm/rev)	ap (mm)	vc (m/min)	f (mm/rev)	ap (mm)	vc (m/min)	f (mm/rev)	ap (mm)	vc (m/min)	f (mm/rev)	ap (mm)	vc (m/min)	f (mm/rev)	ap (mm)	vc (m/min)	f (mm/rev)	ap (mm)
	●	0.4	150	0.20	2.0	75	0.20	2.0	135	0.20	2.0	-	-	-	-	-	-	25	0.14	0.3
	●	0.8	160	0.27	2.0	85	0.27	2.0	145	0.27	2.0	-	-	-	-	-	-	25	0.14	0.7

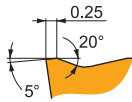
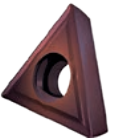

RM3 chip breaker is robust and designed for roughing of Steels and Cast irons. It features positive rake angle and negative, wide T-land. It's also conditionally suitable for Stainless steels and Hard materials.

TCMT 16T304E-RM3:T8415	●	0.4	150	0.20	2.0	75	0.20	2.0	135	0.20	2.0	-	-	-	-	-	-	25	0.14	0.3
TCMT 16T308E-RM3:T8415	●	0.8	160	0.27	2.0	85	0.27	2.0	145	0.27	2.0	-	-	-	-	-	-	25	0.14	0.7



FF

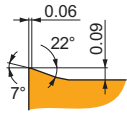

FF chip breaker is sharp and designed for fine-finishing of Steels, Stainless steels. It features positive rake angle and positive, thin T-land. It's also conditionally suitable for Cast irons.



CNMG

	IC	D1	L	S
	(mm)	(mm)	(mm)	(mm)
1204	12.700	5.16	12.90	4.76

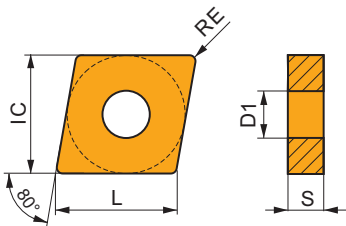

DNMG

	IC	D1	L	S
	(mm)	(mm)	(mm)	(mm)
1104	9.525	3.81	11.60	4.76
1506	12.700	5.16	15.50	6.35

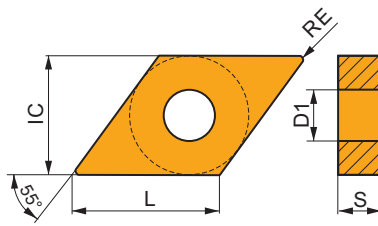

TNMG

	IC	D1	L	S
	(mm)	(mm)	(mm)	(mm)
1604	9.525	3.81	16.50	4.76

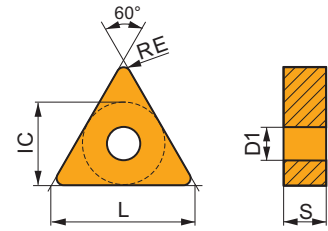

VNMG

	IC	D1	L	S
	(mm)	(mm)	(mm)	(mm)
1604	9.525	3.81	16.60	4.76

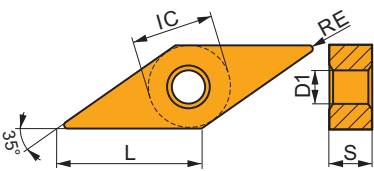

WNMG

	IC	D1	L	S
	(mm)	(mm)	(mm)	(mm)
0604	9.525	3.81	6.50	4.76
0804	12.700	5.16	8.70	4.76

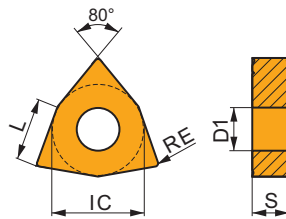



Suitability and starting values for cutting speed (vc), feed (f) and depth of cut (ap). Refer to our Machining Calculator app for further calculations.

Product	Interrupted/ Continuous cut	RE (mm)	P			M			K			N			S			H		
			vc (m/min)	f (mm/rev)	ap (mm)	vc (m/min)	f (mm/rev)	ap (mm)	vc (m/min)	f (mm/rev)	ap (mm)	vc (m/min)	f (mm/rev)	ap (mm)	vc (m/min)	f (mm/rev)	ap (mm)	vc (m/min)	f (mm/rev)	ap (mm)

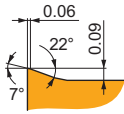
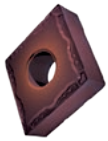

FF chip breaker is sharp and designed for fine-finishing of Steels, Stainless steels. It features positive rake angle and positive, thin T-land. It's also conditionally suitable for Cast irons.

CNMG 120404E-FF:T8415	●	0.4	260	0.12	1.0	135	0.11	1.0	240	0.12	1.0	-	-	-	-	-	-	-	-
CNMG 120408E-FF:T8415	●	0.8	300	0.15	1.0	155	0.14	1.0	270	0.15	1.0	-	-	-	-	-	-	-	-

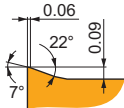

FF chip breaker is sharp and designed for fine-finishing of Steels, Stainless steels. It features positive rake angle and positive, thin T-land. It's also conditionally suitable for Cast irons.

DNMG 110402E-FF:T8415	●	0.4	215	0.10	0.8	110	0.09	0.8	195	0.10	0.8	-	-	-	-	-	-	-	-
DNMG 110404E-FF:T8415	●	0.4	215	0.12	0.8	110	0.11	0.8	195	0.12	0.8	-	-	-	-	-	-	-	-
DNMG 110408E-FF:T8415	●	0.4	240	0.15	0.8	125	0.14	0.8	215	0.15	0.8	-	-	-	-	-	-	-	-
DNMG 150604E-FF:T8415	●	0.8	210	0.12	1.0	110	0.11	1.0	190	0.12	1.0	-	-	-	-	-	-	-	-
DNMG 150608E-FF:T8415	●	0.8	240	0.15	1.0	125	0.14	1.0	215	0.15	1.0	-	-	-	-	-	-	-	-

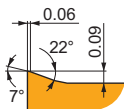
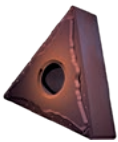

FF chip breaker is sharp and designed for fine-finishing of Steels, Stainless steels. It features positive rake angle and positive, thin T-land. It's also conditionally suitable for Cast irons.

TNMG 160404E-FF:T8415	●	0.4	225	0.12	1.0	115	0.11	1.0	205	0.12	1.0	-	-	-	-	-	-	-	-
TNMG 160408E-FF:T8415	●	0.8	250	0.15	1.0	130	0.14	1.0	225	0.15	1.0	-	-	-	-	-	-	-	-

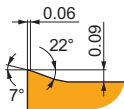

FF chip breaker is sharp and designed for fine-finishing of Steels, Stainless steels. It features positive rake angle and positive, thin T-land. It's also conditionally suitable for Cast irons.

VNMG 160404E-FF:T8415	●	0.4	185	0.12	1.0	95	0.11	1.0	165	0.12	1.0	-	-	-	-	-	-	-	-
-----------------------	---	-----	-----	------	-----	----	------	-----	-----	------	-----	---	---	---	---	---	---	---	---

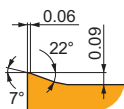

FF chip breaker is sharp and designed for fine-finishing of Steels, Stainless steels. It features positive rake angle and positive, thin T-land. It's also conditionally suitable for Cast irons.

WNMG 060402E-FF:T8415	●	0.2	260	0.10	1.0	135	0.09	1.0	240	0.10	1.0	-	-	-	-	-	-	-	-
WNMG 060404E-FF:T8415	●	0.4	260	0.12	1.0	135	0.11	1.0	240	0.12	1.0	-	-	-	-	-	-	-	-
WNMG 080404E-FF:T8415	●	0.4	260	0.12	1.0	135	0.11	1.0	240	0.12	1.0	-	-	-	-	-	-	-	-
WNMG 080408E-FF:T8415	●	0.8	300	0.15	1.0	155	0.14	1.0	270	0.15	1.0	-	-	-	-	-	-	-	-



FM

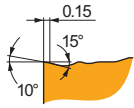

FM chip breaker is versatile and the first choice for finishing of Steels and Cast irons. It features slightly positive rake angle and positive, narrow T-land. It's also conditionally suitable for Stainless steels and Super-alloys.



CNMG

	IC	D1	L	S
	(mm)	(mm)	(mm)	(mm)
1204	12.700	5.16	12.90	4.76

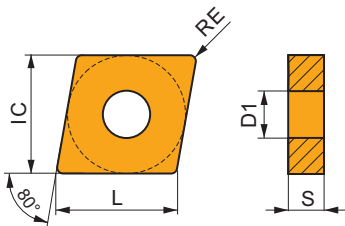

DNMG

	IC	D1	L	S
	(mm)	(mm)	(mm)	(mm)
1104	9.525	3.81	11.60	4.76
1506	12.700	5.16	15.50	6.35

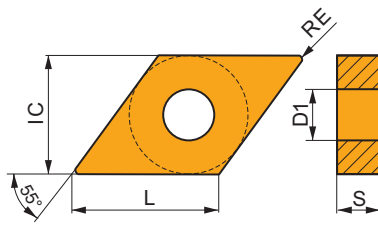

SNMG

	IC	D1	L	S
	(mm)	(mm)	(mm)	(mm)
1204	12.700	5.16	12.70	4.76

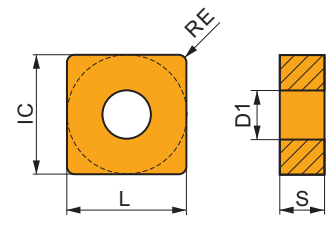

TNMG

	IC	D1	L	S
	(mm)	(mm)	(mm)	(mm)
1604	9.525	3.81	16.50	4.76

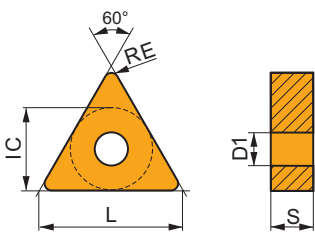

WNMG

	IC	D1	L	S
	(mm)	(mm)	(mm)	(mm)
0604	9.525	3.81	6.50	4.76
0804	12.700	5.16	8.70	4.76

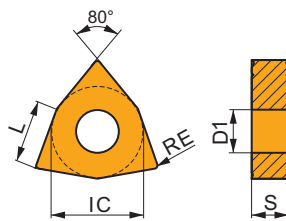



Suitability and starting values for cutting speed (vc), feed (f) and depth of cut (ap). Refer to our Machining Calculator app for further calculations.

Product	Interrupted/ Continuous cut	RE (mm)	P			M			K			N			S			H		
			vc	f	ap	vc	f	ap	vc	f	ap	vc	f	ap	vc	f	ap	vc	f	ap
			(m/min)	(mm/rev)	(mm)	(m/min)	(mm/rev)	(mm)	(m/min)	(mm/rev)	(mm)	(m/min)	(mm/rev)	(mm)	(m/min)	(mm/rev)	(mm)	(m/min)	(mm/rev)	(mm)

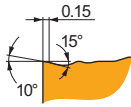
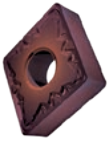

FM chip breaker is versatile and the first choice for finishing of Steels and Cast irons. It features slightly positive rake angle and positive, narrow T-land. It's also conditionally suitable for Stainless steels and Super-alloys.

CNMG 120404E-FM:T8415	●	0.4	■	215	0.20	2.1	☑	110	0.18	2.1	■	195	0.20	2.1	–	–	–	☑	45	0.14	1.7	–	–	–
CNMG 120408E-FM:T8415	⊛	0.8	■	250	0.20	2.1	☑	130	0.18	2.1	■	225	0.20	2.1	–	–	–	☑	55	0.16	1.7	–	–	–

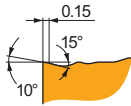

FM chip breaker is versatile and the first choice for finishing of Steels and Cast irons. It features slightly positive rake angle and positive, narrow T-land. It's also conditionally suitable for Stainless steels and Super-alloys.

DNMG 110404E-FM:T8415	●	0.4	■	185	0.20	0.8	☑	95	0.18	0.8	■	165	0.20	0.8	–	–	–	☑	40	0.14	0.6	–	–	–
DNMG 110408E-FM:T8415	●	0.8	■	220	0.20	0.8	☑	115	0.18	0.8	■	200	0.20	0.8	–	–	–	☑	50	0.14	0.6	–	–	–
DNMG 150604E-FM:T8415	●	0.4	■	170	0.20	1.7	☑	90	0.18	1.7	■	155	0.20	1.7	–	–	–	☑	35	0.14	1.4	–	–	–
DNMG 150608E-FM:T8415	●	0.8	■	210	0.20	1.7	☑	110	0.18	1.7	■	190	0.20	1.7	–	–	–	☑	45	0.16	1.4	–	–	–

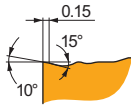
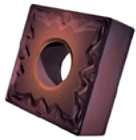

FM chip breaker is versatile and the first choice for finishing of Steels and Cast irons. It features slightly positive rake angle and positive, narrow T-land. It's also conditionally suitable for Stainless steels and Super-alloys.

SNMG 120404E-FM:T8415	●	0.4	■	220	0.20	2.1	☑	115	0.18	2.1	■	200	0.20	2.1	–	–	–	☑	50	0.14	1.7	–	–	–
SNMG 120408E-FM:T8415	⊛	0.8	■	260	0.20	2.1	☑	135	0.18	2.1	■	240	0.20	2.1	–	–	–	☑	60	0.16	1.7	–	–	–

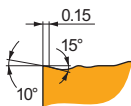
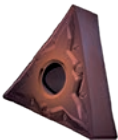

FM chip breaker is versatile and the first choice for finishing of Steels and Cast irons. It features slightly positive rake angle and positive, narrow T-land. It's also conditionally suitable for Stainless steels and Super-alloys.

TNMG 160404E-FM:T8415	●	0.4	■	185	0.20	1.7	☑	95	0.18	1.7	■	165	0.20	1.7	–	–	–	☑	40	0.14	1.4	–	–	–
TNMG 160408E-FM:T8415	●	0.8	■	220	0.20	1.7	☑	115	0.18	1.7	■	200	0.20	1.7	–	–	–	☑	50	0.16	1.4	–	–	–

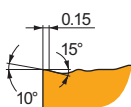
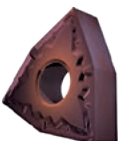

FM chip breaker is versatile and the first choice for finishing of Steels and Cast irons. It features slightly positive rake angle and positive, narrow T-land. It's also conditionally suitable for Stainless steels and Super-alloys.

WNMG 060404E-FM:T8415	●	0.4	■	220	0.20	1.4	☑	115	0.18	1.4	■	200	0.20	1.4	–	–	–	☑	50	0.14	1.1	–	–	–
WNMG 080404E-FM:T8415	●	0.4	■	215	0.20	1.9	☑	110	0.18	1.9	■	195	0.20	1.9	–	–	–	☑	45	0.14	1.5	–	–	–
WNMG 080408E-FM:T8415	⊛	0.8	■	250	0.20	1.9	☑	130	0.18	1.9	■	225	0.20	1.9	–	–	–	☑	55	0.16	1.5	–	–	–



SF

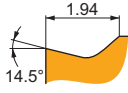

SF chip breaker is sharp and the first choice for finishing of Stainless steels and Super-alloys. It features slightly positive rake angle without T-land. It's also suitable for Steels, Cast irons and Hard materials, and conditionally for Non-ferrous alloys.



CNGG

	IC	D1	L	S
	(mm)	(mm)	(mm)	(mm)
1204	12.700	5.16	12.90	4.76

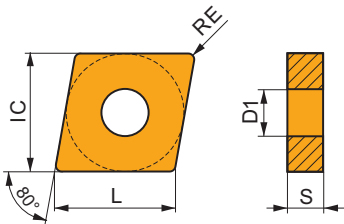

CNMG

	IC	D1	L	S
	(mm)	(mm)	(mm)	(mm)
1204	12.700	5.16	12.90	4.76

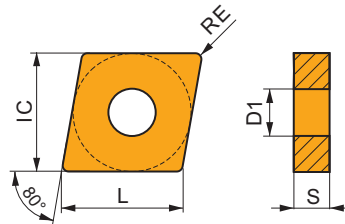

DNMG

	IC	D1	L	S
	(mm)	(mm)	(mm)	(mm)
1104	9.525	3.81	11.60	4.76
1504	12.700	5.16	15.50	4.76
1506	12.700	5.16	15.50	6.35

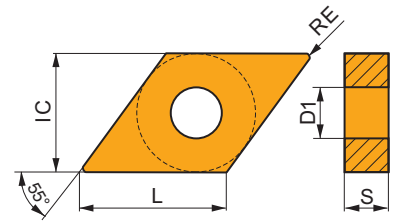

SNMG

	IC	D1	L	S
	(mm)	(mm)	(mm)	(mm)
1204	12.700	5.16	12.70	4.76

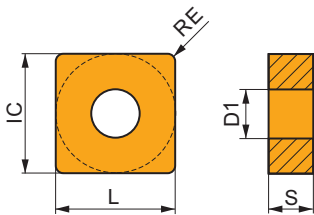

TNMG

	IC	D1	L	S
	(mm)	(mm)	(mm)	(mm)
1604	9.525	3.81	16.50	4.76
2204	12.700	5.16	22.00	4.76

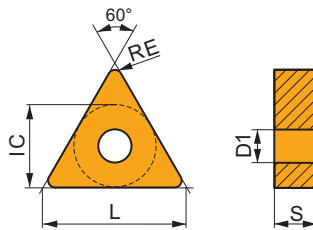

VNMG

	IC	D1	L	S
	(mm)	(mm)	(mm)	(mm)
1604	9.525	3.81	16.60	4.76

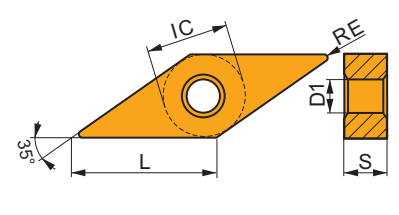

WNMG

	IC	D1	L	S
	(mm)	(mm)	(mm)	(mm)
0604	9.525	3.81	6.50	4.76
0804	12.700	5.16	8.70	4.76

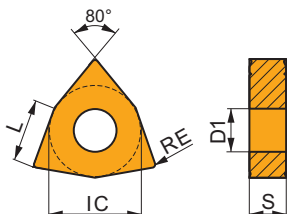



Suitability and starting values for cutting speed (vc), feed (f) and depth of cut (ap). Refer to our Machining Calculator app for further calculations.

Product	Interrupted/ Continuous cut	RE (mm)	P			M			K			N			S			H		
			vc (m/min)	f (mm/rev)	ap (mm)	vc (m/min)	f (mm/rev)	ap (mm)	vc (m/min)	f (mm/rev)	ap (mm)	vc (m/min)	f (mm/rev)	ap (mm)	vc (m/min)	f (mm/rev)	ap (mm)	vc (m/min)	f (mm/rev)	ap (mm)

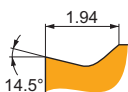
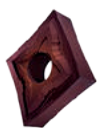

SF chip breaker is sharp and the first choice for finishing of Stainless steels and Super-alloys. It features slightly positive rake angle without T-land. It's also suitable for Steels, Cast irons and Hard materials, and conditionally for Non-ferrous alloys.

CNGG 120402E-SF:T8415	●	0.2	250	0.10	1.0	130	0.09	1.0	225	0.10	1.0	630	0.12	1.0	55	0.08	0.8	40	0.10	0.2
------------------------------	---	-----	-----	------	-----	-----	------	-----	-----	------	-----	-----	------	-----	----	------	-----	----	------	-----

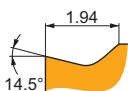
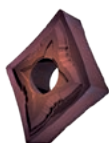

SF chip breaker is sharp and the first choice for finishing of Stainless steels and Super-alloys. It features slightly positive rake angle without T-land. It's also suitable for Steels, Cast irons and Hard materials, and conditionally for Non-ferrous alloys.

CNMG 120404E-SF:T8415	●	0.4	240	0.15	1.0	125	0.14	1.0	215	0.15	1.0	600	0.18	1.0	55	0.12	0.8	40	0.10	0.3
CNMG 120408E-SF:T8415	⊕	0.8	255	0.20	1.0	135	0.18	1.0	230	0.20	1.0	645	0.24	1.0	55	0.14	0.8	45	0.10	0.7
CNMG 120412E-SF:T8415	⊕	1.2	250	0.25	1.5	130	0.23	1.5	225	0.25	1.5	630	0.30	1.5	55	0.17	1.2	40	0.13	1.0

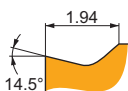

SF chip breaker is sharp and the first choice for finishing of Stainless steels and Super-alloys. It features slightly positive rake angle without T-land. It's also suitable for Steels, Cast irons and Hard materials, and conditionally for Non-ferrous alloys.

DNMG 110404E-SF:T8415	●	0.4	190	0.15	0.8	100	0.14	0.8	170	0.15	0.8	480	0.18	0.8	40	0.12	0.6	30	0.10	0.3
DNMG 110408E-SF:T8415	●	0.8	220	0.17	0.8	115	0.15	0.8	200	0.17	0.8	555	0.20	0.8	50	0.14	0.6	35	0.11	0.7
DNMG 150404E-SF:T8415	●	0.4	180	0.15	1.5	90	0.14	1.5	160	0.15	1.5	450	0.18	1.5	40	0.12	1.2	30	0.10	0.3
DNMG 150408E-SF:T8415	●	0.8	210	0.17	1.5	110	0.15	1.5	190	0.17	1.5	525	0.20	1.5	45	0.14	1.2	35	0.11	0.7
DNMG 150604E-SF:T8415	●	0.4	180	0.15	1.5	90	0.14	1.5	160	0.15	1.5	450	0.18	1.5	40	0.12	1.2	30	0.10	0.3
DNMG 150608E-SF:T8415	●	0.8	210	0.17	1.5	110	0.15	1.5	190	0.17	1.5	525	0.20	1.5	45	0.14	1.2	35	0.11	0.7
DNMG 150612E-SF:T8415	⊕	1.2	195	0.25	1.5	100	0.23	1.5	180	0.25	1.5	495	0.30	1.5	45	0.17	1.2	30	0.13	0.9

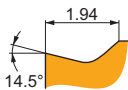
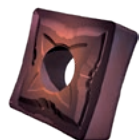

SF chip breaker is sharp and the first choice for finishing of Stainless steels and Super-alloys. It features slightly positive rake angle without T-land. It's also suitable for Steels, Cast irons and Hard materials, and conditionally for Non-ferrous alloys.

SNMG 120408E-SF:T8415	⊕	0.8	275	0.20	1.0	140	0.18	1.0	250	0.20	1.0	690	0.24	1.0	60	0.14	0.8	45	0.10	0.7
SNMG 120412E-SF:T8415	⊕	1.2	260	0.25	1.5	135	0.23	1.5	240	0.25	1.5	660	0.30	1.5	60	0.17	1.2	45	0.13	1.0

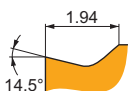

SF chip breaker is sharp and the first choice for finishing of Stainless steels and Super-alloys. It features slightly positive rake angle without T-land. It's also suitable for Steels, Cast irons and Hard materials, and conditionally for Non-ferrous alloys.

TNMG 160404E-SF:T8415	●	0.4	195	0.15	1.3	100	0.14	1.3	180	0.15	1.3	495	0.18	1.3	45	0.12	1.0	30	0.10	0.3
TNMG 160408E-SF:T8415	●	0.8	225	0.17	1.3	115	0.15	1.3	205	0.17	1.3	570	0.20	1.3	50	0.14	1.0	35	0.11	0.7
TNMG 160412E-SF:T8415	⊕	1.2	210	0.25	1.5	110	0.23	1.5	190	0.25	1.5	525	0.30	1.5	45	0.17	1.2	35	0.13	0.9
TNMG 220404E-SF:T8415	●	0.4	185	0.17	1.7	95	0.15	1.7	165	0.17	1.7	465	0.20	1.7	40	0.15	1.4	30	0.12	0.3
TNMG 220408E-SF:T8415	●	0.8	220	0.17	1.7	115	0.15	1.7	200	0.17	1.7	555	0.20	1.7	50	0.15	1.4	35	0.12	0.7
TNMG 220412E-SF:T8415	⊕	1.2	195	0.30	1.7	100	0.27	1.7	180	0.30	1.7	495	0.36	1.7	45	0.21	1.4	30	0.15	0.9

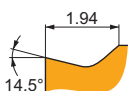

SF chip breaker is sharp and the first choice for finishing of Stainless steels and Super-alloys. It features slightly positive rake angle without T-land. It's also suitable for Steels, Cast irons and Hard materials, and conditionally for Non-ferrous alloys.

VNMG 160404E-SF:T8415	●	0.4	160	0.15	1.2	85	0.14	1.2	145	0.15	1.2	405	0.18	1.2	35	0.14	1.0	25	0.15	0.3
VNMG 160408E-SF:T8415	●	0.8	185	0.17	1.4	95	0.15	1.4	165	0.17	1.4	465	0.20	1.4	40	0.14	1.1	30	0.11	0.7

● Stable working conditions ⊕ Unstable working conditions ⊕ Heavy working conditions ■ Primary use ▣ Possible use



Suitability and starting values for cutting speed (vc), feed (f) and depth of cut (ap). Refer to our Machining Calculator app for further calculations.

Product	Interrupted/ Continuous cut	RE (mm)	P			M			K			N			S			H		
			vc	f	ap	vc	f	ap	vc	f	ap	vc	f	ap	vc	f	ap	vc	f	ap
			(m/min)	(mm/rev)	(mm)	(m/min)	(mm/rev)	(mm)	(m/min)	(mm/rev)	(mm)	(m/min)	(mm/rev)	(mm)	(m/min)	(mm/rev)	(mm)	(m/min)	(mm/rev)	(mm)

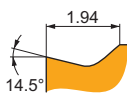
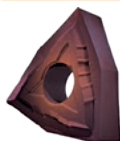

SF chip breaker is sharp and the first choice for finishing of Stainless steels and Super-alloys. It features slightly positive rake angle without T-land. It's also suitable for Steels, Cast irons and Hard materials, and conditionally for Non-ferrous alloys.

WNMG 060404E-SF:T8415	●	0.4	■	240	0.15	1.0	■	125	0.14	1.0	■	215	0.15	1.0	▣	600	0.18	1.0	■	55	0.12	0.8	■	40	0.10	0.3
WNMG 060408E-SF:T8415	●	0.8	■	255	0.20	1.0	■	135	0.18	1.0	■	230	0.20	1.0	▣	645	0.24	1.0	■	55	0.14	0.8	■	45	0.10	0.7
WNMG 080404E-SF:T8415	●	0.4	■	240	0.15	1.0	■	125	0.14	1.0	■	215	0.15	1.0	▣	600	0.18	1.0	■	55	0.12	0.8	■	40	0.10	0.3
WNMG 080408E-SF:T8415	●	0.8	■	255	0.20	1.0	■	135	0.18	1.0	■	230	0.20	1.0	▣	645	0.24	1.0	■	55	0.14	0.8	■	45	0.10	0.7



SM

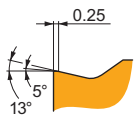

SM chip breaker is versatile and the first choice for medium machining of Steels and Super-alloys. It features slightly positive rake angle and stable, moderate T-land. It's also suitable for Stainless steels, Cast irons, and conditionally for Non-ferrous alloys and Hard materials.



CNMG

IC	D1	L	S	
				(mm)
1204	12.700	5.16	12.90	4.76
1606	15.875	6.35	16.10	6.35
1906	19.050	7.94	19.30	6.35

DNMG

IC	D1	L	S	
				(mm)
1104	9.525	3.81	11.60	4.76
1504	12.700	5.16	15.50	4.76
1506	12.700	5.16	15.50	6.35

SNMG

IC	D1	L	S	
				(mm)
1204	12.700	5.16	12.70	4.76
1906	19.050	7.94	19.05	6.35

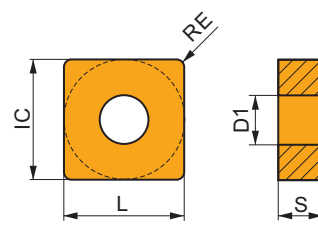
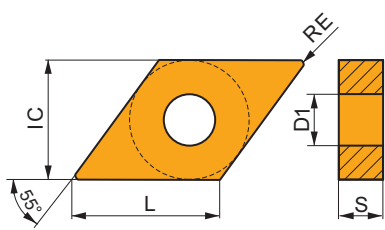
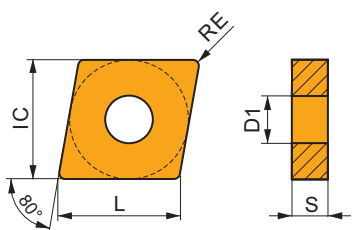

TNMG

IC	D1	L	S	
				(mm)
1604	9.525	3.81	16.50	4.76
2204	12.700	5.16	22.00	4.76

VNMG

IC	D1	L	S	
				(mm)
1604	9.525	3.81	16.60	4.76

WNMG

IC	D1	L	S	
				(mm)
0604	9.525	3.81	6.50	4.76
0804	12.700	5.16	8.70	4.76

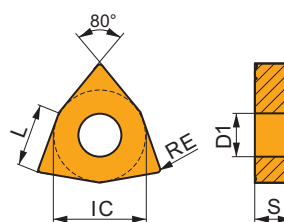
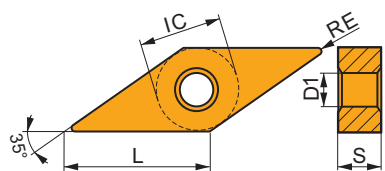
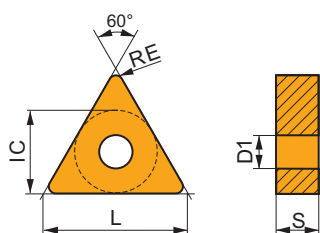

Suitability and starting values for cutting speed (vc), feed (f) and depth of cut (ap). Refer to our Machining Calculator app for further calculations.

Product	Interrupted/ Continuous cut	RE (mm)	P			M			K			N			S			H		
			vc	f	ap	vc	f	ap	vc	f	ap	vc	f	ap	vc	f	ap	vc	f	ap
			(m/min)	(mm/rev)	(mm)	(m/min)	(mm/rev)	(mm)	(m/min)	(mm/rev)	(mm)	(m/min)	(mm/rev)	(mm)	(m/min)	(mm/rev)	(mm)	(m/min)	(mm/rev)	(mm)

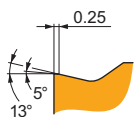

SM chip breaker is versatile and the first choice for medium machining of Steels and Super-alloys. It features slightly positive rake angle and stable, moderate T-land. It's also suitable for Stainless steels, Cast irons, and conditionally for Non-ferrous alloys and Hard materials.

CNMG 120404E-SM:T8415	●	0.4	200	0.20	2.0	105	0.18	2.0	185	0.20	2.0	510	0.24	2.0	45	0.18	1.6	35	0.13	0.3
CNMG 120408E-SM:T8415	●	0.8	225	0.25	2.0	115	0.23	2.0	205	0.25	2.0	570	0.30	2.0	50	0.20	1.6	35	0.13	0.7
CNMG 120412E-SM:T8415	●	1.2	225	0.30	2.0	115	0.27	2.0	205	0.30	2.0	570	0.36	2.0	50	0.24	1.6	35	0.15	1.0
CNMG 160612E-SM:T8415	●	1.2	215	0.30	3.0	110	0.27	3.0	195	0.30	3.0	540	0.36	3.0	45	0.27	2.4	35	0.15	1.0
CNMG 190612E-SM:T8415	●	1.2	210	0.30	4.0	110	0.27	4.0	190	0.30	4.0	525	0.36	4.0	45	0.27	3.2	35	0.15	1.0

● Stable working conditions ● Unstable working conditions ● Heavy working conditions ■ Primary use ▣ Possible use



Suitability and starting values for cutting speed (vc), feed (f) and depth of cut (ap). Refer to our Machining Calculator app for further calculations.

Product	Interrupted/ Continuous cut	RE (mm)	P			M			K			N			S			H		
			vc (m/min)	f (mm/rev)	ap (mm)	vc (m/min)	f (mm/rev)	ap (mm)	vc (m/min)	f (mm/rev)	ap (mm)	vc (m/min)	f (mm/rev)	ap (mm)	vc (m/min)	f (mm/rev)	ap (mm)	vc (m/min)	f (mm/rev)	ap (mm)

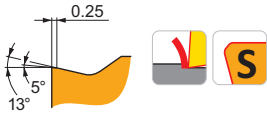

SM chip breaker is versatile and the first choice for medium machining of Steels and Super-alloys. It features slightly positive rake angle and stable, moderate T-land. It's also suitable for Stainless steels, Cast irons, and conditionally for Non-ferrous alloys and Hard materials.

DNMG 110404E-SM:T8415	●	0.4	180	0.20	0.8	90	0.18	0.8	160	0.20	0.8	450	0.24	0.8	40	0.18	0.6	30	0.14	0.3
DNMG 110408E-SM:T8415	●	0.8	190	0.25	1.2	100	0.23	1.2	170	0.25	1.2	480	0.30	1.2	40	0.20	1.0	30	0.13	0.7
DNMG 150404E-SM:T8415	●	0.4	165	0.20	1.7	85	0.18	1.7	150	0.20	1.7	420	0.24	1.7	35	0.18	1.4	25	0.14	0.3
DNMG 150408E-SM:T8415	●	0.8	185	0.25	1.7	95	0.23	1.7	165	0.25	1.7	465	0.30	1.7	40	0.20	1.4	30	0.13	0.7
DNMG 150604E-SM:T8415	●	0.4	165	0.20	1.7	85	0.18	1.7	150	0.20	1.7	420	0.24	1.7	35	0.18	1.4	25	0.14	0.3
DNMG 150608E-SM:T8415	●	0.8	185	0.25	1.7	95	0.23	1.7	165	0.25	1.7	465	0.30	1.7	40	0.20	1.4	30	0.13	0.7
DNMG 150612E-SM:T8415	●	1.2	185	0.30	1.7	95	0.27	1.7	165	0.30	1.7	465	0.36	1.7	40	0.24	1.4	30	0.15	0.9

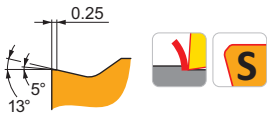
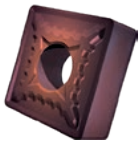

SM chip breaker is versatile and the first choice for medium machining of Steels and Super-alloys. It features slightly positive rake angle and stable, moderate T-land. It's also suitable for Stainless steels, Cast irons, and conditionally for Non-ferrous alloys and Hard materials.

SNMG 120408E-SM:T8415	●	0.8	240	0.25	1.8	125	0.23	1.8	215	0.25	1.8	600	0.30	1.8	55	0.20	1.4	40	0.13	0.7
SNMG 190612E-SM:T8415	●	1.2	220	0.30	4.0	115	0.27	4.0	200	0.30	4.0	555	0.36	4.0	50	0.27	3.2	35	0.15	1.0

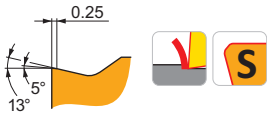
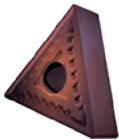

SM chip breaker is versatile and the first choice for medium machining of Steels and Super-alloys. It features slightly positive rake angle and stable, moderate T-land. It's also suitable for Stainless steels, Cast irons, and conditionally for Non-ferrous alloys and Hard materials.

TNMG 160404E-SM:T8415	●	0.4	170	0.20	1.7	90	0.18	1.7	155	0.20	1.7	435	0.24	1.7	35	0.18	1.4	30	0.14	0.3
TNMG 160408E-SM:T8415	●	0.8	195	0.25	1.7	100	0.23	1.7	180	0.25	1.7	495	0.30	1.7	45	0.20	1.4	30	0.13	0.7
TNMG 160412E-SM:T8415	●	1.2	195	0.30	1.7	100	0.27	1.7	180	0.30	1.7	495	0.36	1.7	45	0.24	1.4	30	0.15	0.9
TNMG 220404E-SM:T8415	●	0.4	170	0.20	1.7	90	0.18	1.7	155	0.20	1.7	435	0.24	1.7	35	0.18	1.4	30	0.14	0.3
TNMG 220408E-SM:T8415	●	0.8	195	0.25	1.7	100	0.23	1.7	180	0.25	1.7	495	0.30	1.7	45	0.20	1.4	30	0.13	0.7
TNMG 220412E-SM:T8415	●	1.2	195	0.30	1.7	100	0.27	1.7	180	0.30	1.7	495	0.36	1.7	45	0.24	1.4	30	0.15	0.9

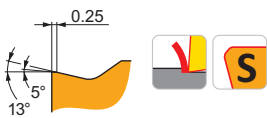

SM chip breaker is versatile and the first choice for medium machining of Steels and Super-alloys. It features slightly positive rake angle and stable, moderate T-land. It's also suitable for Stainless steels, Cast irons, and conditionally for Non-ferrous alloys and Hard materials.

VNMG 160404E-SM:T8415	●	0.4	155	0.18	1.2	80	0.16	1.2	140	0.18	1.2	390	0.22	1.2	35	0.16	1.0	25	0.13	0.3
VNMG 160408E-SM:T8415	●	0.8	160	0.25	1.4	85	0.23	1.4	145	0.25	1.4	405	0.30	1.4	35	0.20	1.1	25	0.13	0.7

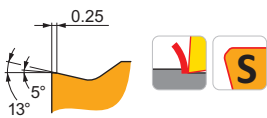
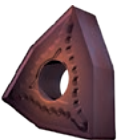

SM chip breaker is versatile and the first choice for medium machining of Steels and Super-alloys. It features slightly positive rake angle and stable, moderate T-land. It's also suitable for Stainless steels, Cast irons, and conditionally for Non-ferrous alloys and Hard materials.

WNMG 060408E-SM:T8415	●	0.8	225	0.25	1.7	115	0.23	1.7	205	0.25	1.7	570	0.30	1.7	50	0.20	1.4	35	0.13	0.7
WNMG 080404E-SM:T8415	●	0.4	200	0.20	2.0	105	0.18	2.0	185	0.20	2.0	510	0.24	2.0	45	0.18	1.6	35	0.13	0.3
WNMG 080408E-SM:T8415	●	0.8	225	0.25	2.0	115	0.23	2.0	205	0.25	2.0	570	0.30	2.0	50	0.20	1.6	35	0.13	0.7
WNMG 080412E-SM:T8415	●	1.2	225	0.30	2.0	115	0.27	2.0	205	0.30	2.0	570	0.36	2.0	50	0.24	1.6	35	0.15	1.0



SI

SI chip breaker is sharp and designed for medium machining of Steels, Stainless steels. It features positive rake angle without T-land. It's also conditionally suitable for Non-ferrous alloys and Super-alloys.

PRAMET

DNMG

	IC (mm)	D1 (mm)	L (mm)	S (mm)
1506	12.700	5.16	15.50	6.35

TNMG

	IC (mm)	D1 (mm)	L (mm)	S (mm)
1604	9.525	3.81	16.50	4.76

WNMG

	IC (mm)	D1 (mm)	L (mm)	S (mm)
0804	12.700	5.16	8.70	4.76

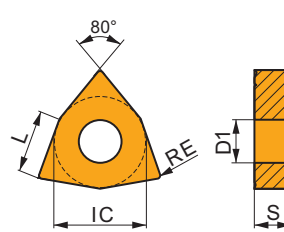
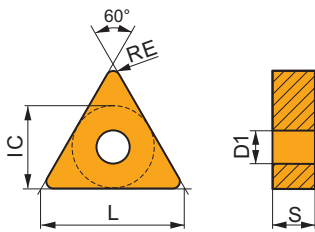
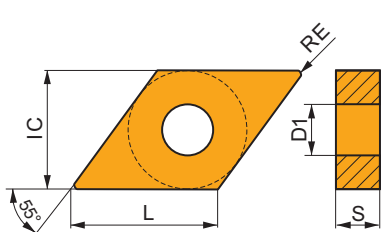

Suitability and starting values for cutting speed (vc), feed (f) and depth of cut (ap). Refer to our Machining Calculator app for further calculations.

Product	Interrupted/ Continuous cut	RE (mm)	P			M			K			N			S			H		
			vc	f	ap	vc	f	ap	vc	f	ap	vc	f	ap	vc	f	ap	vc	f	ap
			(m/min)	(mm/rev)	(mm)	(m/min)	(mm/rev)	(mm)	(m/min)	(mm/rev)	(mm)	(m/min)	(mm/rev)	(mm)	(m/min)	(mm/rev)	(mm)	(m/min)	(mm/rev)	(mm)
	●	0.4	195	0.20	1.5	100	0.18	1.5	—	—	—	495	0.24	1.5	45	0.18	1.2	—	—	—
	●	0.8	200	0.35	1.5	105	0.32	1.5	—	—	—	510	0.42	1.5	45	0.24	1.2	—	—	—
	●	0.8	200	0.35	1.5	105	0.32	1.5	—	—	—	510	0.42	1.5	45	0.24	1.2	—	—	—
	●	0.4	210	0.20	1.5	110	0.18	1.5	—	—	—	525	0.24	1.5	45	0.18	1.2	—	—	—
	●	0.8	215	0.35	1.5	110	0.32	1.5	—	—	—	540	0.42	1.5	45	0.24	1.2	—	—	—
	●	0.4	210	0.20	1.5	110	0.18	1.5	—	—	—	525	0.24	1.5	45	0.18	1.2	—	—	—
	●	0.8	215	0.35	1.5	110	0.32	1.5	—	—	—	540	0.42	1.5	45	0.24	1.2	—	—	—

SI chip breaker is sharp and designed for medium machining of Steels, Stainless steels. It features positive rake angle without T-land. It's also conditionally suitable for Non-ferrous alloys and Super-alloys.

DNMG 150604ER-SI-T8415	●	0.4	195	0.20	1.5	100	0.18	1.5	—	—	—	495	0.24	1.5	45	0.18	1.2	—	—	—
DNMG 150608ER-SI-T8415	●	0.8	200	0.35	1.5	105	0.32	1.5	—	—	—	510	0.42	1.5	45	0.24	1.2	—	—	—

SI chip breaker is sharp and designed for medium machining of Steels, Stainless steels. It features positive rake angle without T-land. It's also conditionally suitable for Non-ferrous alloys and Super-alloys.

DNMG 150608EL-SI-T8415	●	0.8	200	0.35	1.5	105	0.32	1.5	—	—	—	510	0.42	1.5	45	0.24	1.2	—	—	—
-------------------------------	---	-----	-----	------	-----	-----	------	-----	---	---	---	-----	------	-----	----	------	-----	---	---	---

SI chip breaker is sharp and designed for medium machining of Steels, Stainless steels. It features positive rake angle without T-land. It's also conditionally suitable for Non-ferrous alloys and Super-alloys.

TNMG 160404ER-SI-T8415	●	0.4	210	0.20	1.5	110	0.18	1.5	—	—	—	525	0.24	1.5	45	0.18	1.2	—	—	—
TNMG 160408ER-SI-T8415	●	0.8	215	0.35	1.5	110	0.32	1.5	—	—	—	540	0.42	1.5	45	0.24	1.2	—	—	—

SI chip breaker is sharp and designed for medium machining of Steels, Stainless steels. It features positive rake angle without T-land. It's also conditionally suitable for Non-ferrous alloys and Super-alloys.

TNMG 160404EL-SI-T8415	●	0.4	210	0.20	1.5	110	0.18	1.5	—	—	—	525	0.24	1.5	45	0.18	1.2	—	—	—
TNMG 160408EL-SI-T8415	●	0.8	215	0.35	1.5	110	0.32	1.5	—	—	—	540	0.42	1.5	45	0.24	1.2	—	—	—

● Stable working conditions ● Unstable working conditions ⚠ Heavy working conditions ■ Primary use ▣ Possible use



Suitability and starting values for cutting speed (vc), feed (f) and depth of cut (ap). Refer to our Machining Calculator app for further calculations.

Product	Interrupted/ Continuous cut	RE (mm)	P			M			K			N			S			H		
			vc	f	ap	vc	f	ap	vc	f	ap	vc	f	ap	vc	f	ap	vc	f	ap
			(m/min)	(mm/rev)	(mm)	(m/min)	(mm/rev)	(mm)	(m/min)	(mm/rev)	(mm)	(m/min)	(mm/rev)	(mm)	(m/min)	(mm/rev)	(mm)	(m/min)	(mm/rev)	(mm)

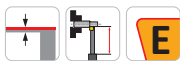
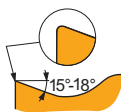
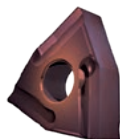

SI chip breaker is sharp and designed for medium machining of Steels, Stainless steels. It features positive rake angle without T-land. It's also conditionally suitable for Non-ferrous alloys and Super-alloys.

WNMG 080404ER-SI:T8415	●	0.4	■	250	0.20	1.7	■	130	0.18	1.7	■	-	-	-	▣	630	0.24	1.7	▣	55	0.18	1.4	■	-	-	-
-------------------------------	---	-----	---	-----	------	-----	---	-----	------	-----	---	---	---	---	---	-----	------	-----	---	----	------	-----	---	---	---	---

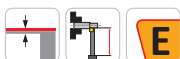
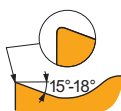
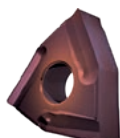

SI chip breaker is sharp and designed for medium machining of Steels, Stainless steels. It features positive rake angle without T-land. It's also conditionally suitable for Non-ferrous alloys and Super-alloys.

WNMG 080404EL-SI:T8415	●	0.4	■	250	0.20	1.7	■	130	0.18	1.7	■	-	-	-	▣	630	0.24	1.7	▣	55	0.18	1.4	■	-	-	-
-------------------------------	---	-----	---	-----	------	-----	---	-----	------	-----	---	---	---	---	---	-----	------	-----	---	----	------	-----	---	---	---	---



NM

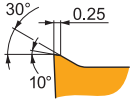

NM chip breaker is sharp and designed for medium machining of Steels, Stainless steels and Super-alloys. It features highly positive rake angle and positive, moderate T-land. It's also conditionally suitable for Non-ferrous alloys.



CNMG

	IC	D1	L	S
	(mm)	(mm)	(mm)	(mm)
1204	12.700	5.16	12.90	4.76

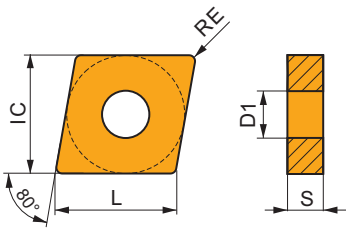

DNMG

	IC	D1	L	S
	(mm)	(mm)	(mm)	(mm)
1104	9.525	3.81	11.60	4.76

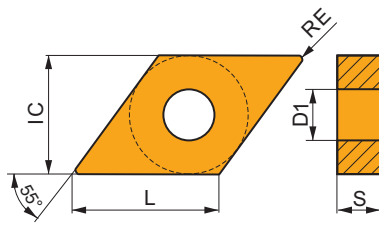

TNMG

	IC	D1	L	S
	(mm)	(mm)	(mm)	(mm)
1604	9.525	3.81	16.50	4.76
2204	12.700	5.16	22.00	4.76

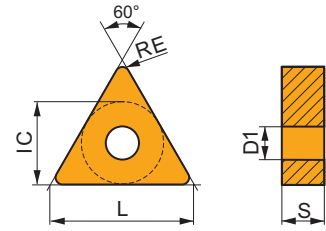

VNMG

	IC	D1	L	S
	(mm)	(mm)	(mm)	(mm)
1604	9.525	3.81	16.60	4.76

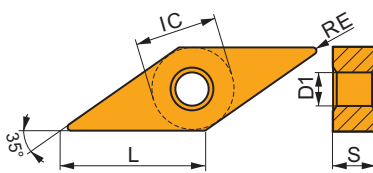

WNMG

	IC	D1	L	S
	(mm)	(mm)	(mm)	(mm)
0804	12.700	5.16	8.70	4.76

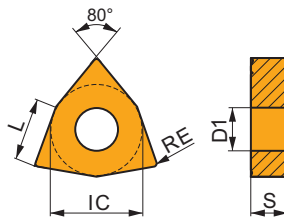



Suitability and starting values for cutting speed (vc), feed (f) and depth of cut (ap). Refer to our Machining Calculator app for further calculations.

Product	Interrupted/ Continuous cut	RE (mm)	P			M			K			N			S			H		
			vc (m/min)	f (mm/rev)	ap (mm)	vc (m/min)	f (mm/rev)	ap (mm)	vc (m/min)	f (mm/rev)	ap (mm)	vc (m/min)	f (mm/rev)	ap (mm)	vc (m/min)	f (mm/rev)	ap (mm)	vc (m/min)	f (mm/rev)	ap (mm)

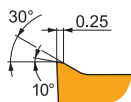
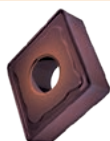

NM chip breaker is sharp and designed for medium machining of Steels, Stainless steels and Super-alloys. It features highly positive rake angle and positive, moderate T-land. It's also conditionally suitable for Non-ferrous alloys.

CNMG 120408E-NM:T8415	●	0.8	■	245	0.25	2.1	■	125	0.23	2.1	■	–	–	–	▣	615	0.30	2.1	■	55	0.20	1.7	■	–	–	–
-----------------------	---	-----	---	-----	------	-----	---	-----	------	-----	---	---	---	---	---	-----	------	-----	---	----	------	-----	---	---	---	---

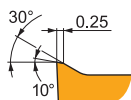

NM chip breaker is sharp and designed for medium machining of Steels, Stainless steels and Super-alloys. It features highly positive rake angle and positive, moderate T-land. It's also conditionally suitable for Non-ferrous alloys.

DNMG 110408E-NM:T8415	●	0.8	■	215	0.25	0.8	■	110	0.23	0.8	■	–	–	–	▣	540	0.30	0.8	■	45	0.20	0.6	■	–	–	–
-----------------------	---	-----	---	-----	------	-----	---	-----	------	-----	---	---	---	---	---	-----	------	-----	---	----	------	-----	---	---	---	---

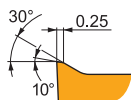
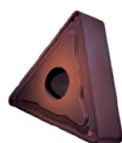

NM chip breaker is sharp and designed for medium machining of Steels, Stainless steels and Super-alloys. It features highly positive rake angle and positive, moderate T-land. It's also conditionally suitable for Non-ferrous alloys.

TNMG 160408E-NM:T8415	●	0.8	■	215	0.25	1.9	■	110	0.23	1.9	■	–	–	–	▣	540	0.30	1.9	■	45	0.20	1.5	■	–	–	–
TNMG 220408E-NM:T8415	●	0.8	■	215	0.25	1.7	■	110	0.23	1.7	■	–	–	–	▣	540	0.30	1.7	■	45	0.20	1.4	■	–	–	–

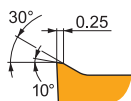

NM chip breaker is sharp and designed for medium machining of Steels, Stainless steels and Super-alloys. It features highly positive rake angle and positive, moderate T-land. It's also conditionally suitable for Non-ferrous alloys.

VNMG 160404E-NM:T8415	●	0.4	■	160	0.20	1.2	■	85	0.18	1.2	■	–	–	–	▣	405	0.24	1.2	■	35	0.20	1.0	■	–	–	–
VNMG 160408E-NM:T8415	●	0.8	■	180	0.25	1.4	■	90	0.23	1.4	■	–	–	–	▣	450	0.30	1.4	■	40	0.20	1.1	■	–	–	–

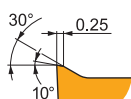
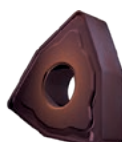

NM chip breaker is sharp and designed for medium machining of Steels, Stainless steels and Super-alloys. It features highly positive rake angle and positive, moderate T-land. It's also conditionally suitable for Non-ferrous alloys.

WNMG 080412E-NM:T8415	●	1.2	■	245	0.30	2.1	■	125	0.27	2.1	■	–	–	–	▣	615	0.36	2.1	■	55	0.24	1.7	■	–	–	–
-----------------------	---	-----	---	-----	------	-----	---	-----	------	-----	---	---	---	---	---	-----	------	-----	---	----	------	-----	---	---	---	---



.NMA

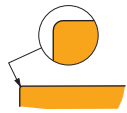

...A flat insert is designed for medium machining of Cast irons. It features neutral rake angle without T-land. It's also conditionally suitable for Hard materials.



CNMA

	IC (mm)	D1 (mm)	L (mm)	S (mm)
1204	12.700	5.16	12.90	4.76

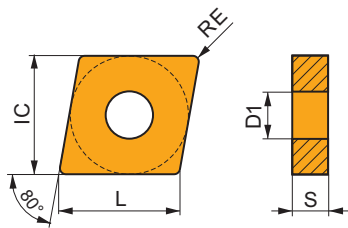

DNMA

	IC (mm)	D1 (mm)	L (mm)	S (mm)
1506	12.700	5.16	15.50	6.35

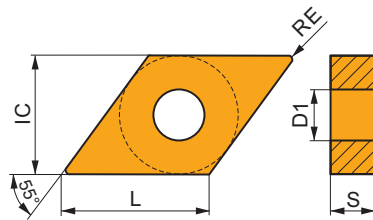

SNMA

	IC (mm)	D1 (mm)	L (mm)	S (mm)
1204	12.700	5.16	12.70	4.76

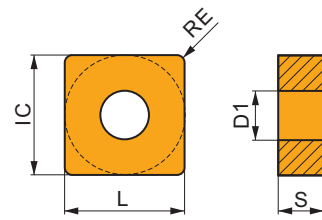

TNMA

	IC (mm)	D1 (mm)	L (mm)	S (mm)
1604	9.525	3.81	16.50	4.76
2204	12.700	5.16	22.00	4.76

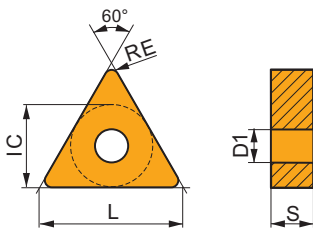

WNMA

	IC (mm)	D1 (mm)	L (mm)	S (mm)
0804	12.700	5.16	8.70	4.76

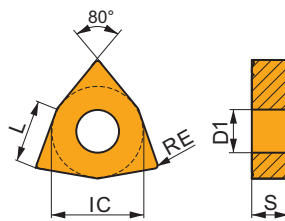



Suitability and starting values for cutting speed (vc), feed (f) and depth of cut (ap). Refer to our Machining Calculator app for further calculations.

Product	Interrupted/ Continuous cut	RE (mm)	P			M			K			N			S			H		
			vc	f	ap	vc	f	ap	vc	f	ap	vc	f	ap	vc	f	ap	vc	f	ap
			(m/min)	(mm/rev)	(mm)	(m/min)	(mm/rev)	(mm)	(m/min)	(mm/rev)	(mm)	(m/min)	(mm/rev)	(mm)	(m/min)	(mm/rev)	(mm)	(m/min)	(mm/rev)	(mm)

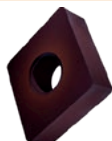

...A flat insert is designed for medium machining of Cast irons. It features neutral rake angle without T-land. It's also conditionally suitable for Hard materials.

CNMA 120408:T8415	●	0.8	–	–	–	–	–	–	■	145	0.20	4.0	–	–	–	–	–	–	■	25	0.14	0.5
CNMA 120412:T8415	●	1.2	–	–	–	–	–	–	■	135	0.30	4.0	–	–	–	–	–	–	■	25	0.21	0.5

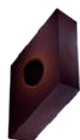

...A flat insert is designed for medium machining of Cast irons. It features neutral rake angle without T-land. It's also conditionally suitable for Hard materials.

DNMA 150604:T8415	●	0.4	–	–	–	–	–	–	■	130	0.10	1.7	–	–	–	–	–	–	■	25	0.07	0.5
DNMA 150608:T8415	●	0.8	–	–	–	–	–	–	■	125	0.20	1.7	–	–	–	–	–	–	■	20	0.14	0.5

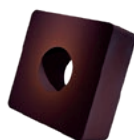

...A flat insert is designed for medium machining of Cast irons. It features neutral rake angle without T-land. It's also conditionally suitable for Hard materials.

SNMA 120408:T8415	●	0.8	–	–	–	–	–	–	■	150	0.20	4.0	–	–	–	–	–	–	■	25	0.14	0.5
-------------------	---	-----	---	---	---	---	---	---	---	-----	------	-----	---	---	---	---	---	---	---	----	------	-----

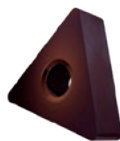

...A flat insert is designed for medium machining of Cast irons. It features neutral rake angle without T-land. It's also conditionally suitable for Hard materials.

TNMA 160408:T8415	●	0.8	–	–	–	–	–	–	■	135	0.20	1.5	–	–	–	–	–	–	■	25	0.14	0.5
TNMA 220408:T8415	●	0.8	–	–	–	–	–	–	■	130	0.20	2.0	–	–	–	–	–	–	■	25	0.14	0.5

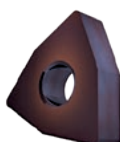

...A flat insert is designed for medium machining of Cast irons. It features neutral rake angle without T-land. It's also conditionally suitable for Hard materials.

WNMA 080408:T8415	●	0.8	–	–	–	–	–	–	■	145	0.20	4.0	–	–	–	–	–	–	■	25	0.14	0.5
WNMA 080412:T8415	●	1.2	–	–	–	–	–	–	■	135	0.30	4.0	–	–	–	–	–	–	■	25	0.21	0.5



RM

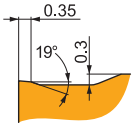

RM chip breaker is robust and the first choice for roughing of Steels. It features positive rake angle and stable, wide T-land. It's also suitable for Stainless steels, Cast irons, and conditionally for Super-alloys.



CNMG

	IC (mm)	D1 (mm)	L (mm)	S (mm)
1204	12.700	5.16	12.90	4.76
1606	15.875	6.35	16.10	6.35
1906	19.050	7.94	19.30	6.35

DNMG

	IC (mm)	D1 (mm)	L (mm)	S (mm)
1506	12.700	5.16	15.50	6.35

SNMG

	IC (mm)	D1 (mm)	L (mm)	S (mm)
1204	12.700	5.16	12.70	4.76
1506	15.875	6.35	15.88	6.35
1906	19.050	7.94	19.05	6.35

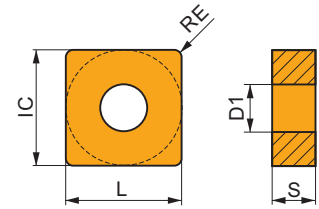
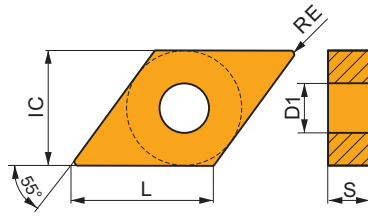
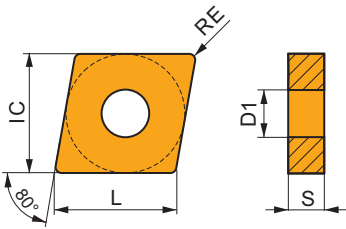

WNMG

	IC (mm)	D1 (mm)	L (mm)	S (mm)
0804	12.700	5.16	8.70	4.76

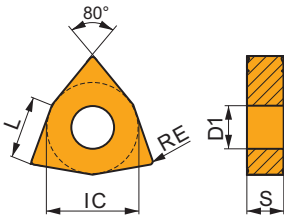



Suitability and starting values for cutting speed (vc), feed (f) and depth of cut (ap). Refer to our Machining Calculator app for further calculations.

Product	Interrupted/ Continuous cut	RE (mm)	P			M			K			N			S			H		
			vc (m/min)	f (mm/rev)	ap (mm)	vc (m/min)	f (mm/rev)	ap (mm)	vc (m/min)	f (mm/rev)	ap (mm)	vc (m/min)	f (mm/rev)	ap (mm)	vc (m/min)	f (mm/rev)	ap (mm)	vc (m/min)	f (mm/rev)	ap (mm)

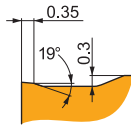

RM chip breaker is robust and the first choice for roughing of Steels. It features positive rake angle and stable, wide T-land. It's also suitable for Stainless steels, Cast irons, and conditionally for Super-alloys.

CNMG 120408E-RM:T8415	●	0.8	195	0.40	4.0	100	0.36	4.0	180	0.40	4.0	-	-	-	45	0.28	3.2	-	-	-
CNMG 120412E-RM:T8415	●	1.2	200	0.45	4.0	105	0.41	4.0	185	0.45	4.0	-	-	-	45	0.32	3.2	-	-	-
CNMG 160612E-RM:T8415	●	1.2	195	0.45	6.0	100	0.41	6.0	180	0.45	6.0	-	-	-	45	0.32	4.8	-	-	-
CNMG 190612E-RM:T8415	●	1.2	195	0.45	7.5	100	0.41	7.5	180	0.45	7.5	-	-	-	45	0.32	6.0	-	-	-
CNMG 190616E-RM:T8415	●	1.6	195	0.50	7.5	100	0.45	7.5	180	0.50	7.5	-	-	-	45	0.35	6.0	-	-	-

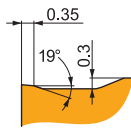

RM chip breaker is robust and the first choice for roughing of Steels. It features positive rake angle and stable, wide T-land. It's also suitable for Stainless steels, Cast irons, and conditionally for Super-alloys.

DNMG 150608E-RM:T8415	●	0.8	160	0.40	3.0	85	0.36	3.0	145	0.40	3.0	-	-	-	35	0.28	2.4	-	-	-
-----------------------	---	-----	-----	------	-----	----	------	-----	-----	------	-----	---	---	---	----	------	-----	---	---	---

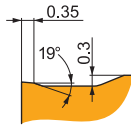
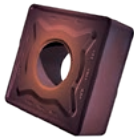

RM chip breaker is robust and the first choice for roughing of Steels. It features positive rake angle and stable, wide T-land. It's also suitable for Stainless steels, Cast irons, and conditionally for Super-alloys.

SNMG 120408E-RM:T8415	●	0.8	210	0.40	4.0	110	0.36	4.0	190	0.40	4.0	-	-	-	45	0.28	3.2	-	-	-
SNMG 120412E-RM:T8415	●	1.2	215	0.45	4.0	110	0.41	4.0	195	0.45	4.0	-	-	-	45	0.32	3.2	-	-	-
SNMG 150612E-RM:T8415	●	1.2	215	0.45	5.0	110	0.41	5.0	195	0.45	5.0	-	-	-	45	0.32	4.0	-	-	-
SNMG 190616E-RM:T8415	●	1.6	210	0.50	7.0	110	0.45	7.0	190	0.50	7.0	-	-	-	45	0.35	5.6	-	-	-

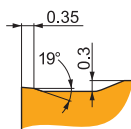
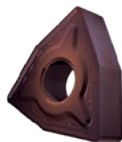

RM chip breaker is robust and the first choice for roughing of Steels. It features positive rake angle and stable, wide T-land. It's also suitable for Stainless steels, Cast irons, and conditionally for Super-alloys.

WNMG 080408E-RM:T8415	●	0.8	195	0.40	4.0	100	0.36	4.0	180	0.40	4.0	-	-	-	45	0.28	3.2	-	-	-
-----------------------	---	-----	-----	------	-----	-----	------	-----	-----	------	-----	---	---	---	----	------	-----	---	---	---



SSO12

VERSATILE HIGH FEED MILLING

INTRODUCTION



Introducing Pramet SSO12 – a new versatile high-feed milling family tailored for challenging workpieces in die and mold industry. Reliable tools with low vibrations, reduced noise, and exceptional power efficiency. Experience smooth cutting action, extended tool life, and significant energy savings – a smart investment into versatility and performance.

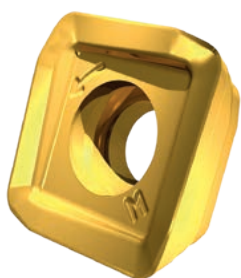

SOHT-M

- Versatile 4-edged HFC insert
- Steels, Cast irons, Hard steels
- Medium up to rough cuts

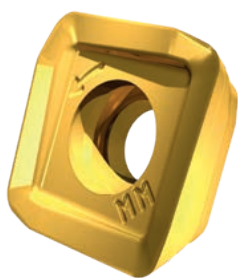

SOHT-MM

- Sharp 4-edged HFC insert
- Soft steels, Stainless steels, HRSA
- Light up to medium cuts



MILLING CUTTERS AND INSERTS

INSERTS FEATURES & BENEFITS

Two reliable geometries M with neutral T-land and MM with positive T-land design.



EASY TO CHOOSE, SIMPLE TO USE

M for strong materials, MM for soft materials.

Precisely ground positive flank and negative seating flats improves clamping stability.



LONG TOOL LIFE AND CONSISTENCY

in any high feed milling operation.

Positive axial setting angle and positive rake angle and T-land.



PERFECT CHIP EVACUATION UPWARDS

makes it ideal for deep pocketing and milling across holes.

Precise cutters with low runout prevent overcutting of chips against the wall.



SMOOTH WALL SURFACE FINISH,

no more chips sticking on the wall.

Long and highly positive wiper edge parallel to both face and wall.



SMOOTH FACE FINISH

after face milling operations.





SSO12

VERSATILE HIGH FEED MILLING

CUTTERS SSO12 – FEATURES & BENEFITS

Optimized shape of insert pocket.



SIMPLE INDEXING
and handling of insert.

Optimized shape of tooth pocket in balance with dense teeth pitch.



SECURE CHIP EVACUATION
in any HFC milling application.

Connection diameter of shell mills according to standard arbor connection diameter.



RELIABLE TRANSMISSION OF TORQUE
from spindle until the cutting edge.

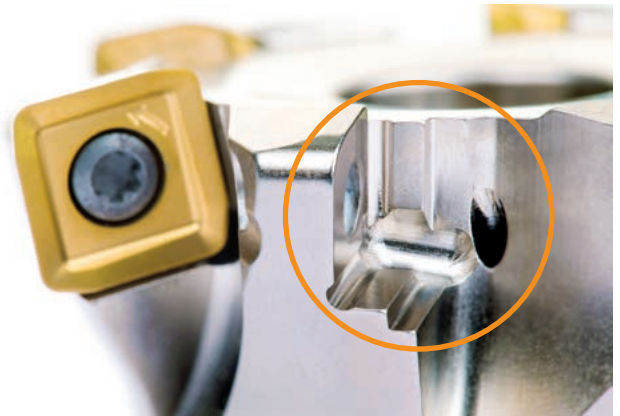

Easily accessible large clamping screws.



SSO12

- Modular shank
- Metric range: 35 – 40 mm
- Imperial range: 1.50"



SSO12

- Cylindrical shank
- Metric range: 35 – 40 mm
- Imperial range: 1.50"



SSO12

- Shell body
- DC range: 42 – 125 mm
- Imperial range: 2.0 – 5.0"



SSO12

VERSATILE HIGH FEED MILLING

HIGH FEED MILLING EXAMPLES

Workpiece: Steel plate face milling
Material: S355NL / 1.0546 (160 HB)
Cutter: 63A06R-SMOSO12-C
Coolant: No (just pressed air)

Cutting conditions:				
v_c	f_z	a_p	a_e	TOH
250	0.96	0.6	44	160

Insert geometry test	Tool life
SOHT 120514SR-MM:M8330	175 min (+133%)

Pramet SSO12 runs significantly smoother than competitor, and according to small wear it would last many more minutes. Even faster table feed rate $F = 10800\text{mm/min}$ (+50%) was tested, still completely stable and fluent cutting!



WMG P2.1

Workpiece: Stainless steel turbine blade
Material: 1.4301 / X5CrNi18 – 10 / SUS304 (170 HB)
Cutter: 50A05R-SMOSO12-C
Coolant: Yes (external, soluble oil emulsion)

Cutting conditions:				
v_c	f_z	a_p	a_e	TOH
125	0.31	1	17.5	140

Insert geometry test	Tool life
SOHT 120514SR-MM:M6330	35 min (+133%)

All competing cutters were all the time buried in chips, there were sudden breakages of inserts and cutters happening. Pramet SSO12 finished the job thanks to improved chip evacuation.



WMG M3.1

Workpiece: Cast steel face and copy milling
Material: G20Mn6N / 1.6220 (180 HB)
Cutter: 63A06R-SMOSO12-C
Coolant: No (just pressed air)

Cutting conditions:				
v_c	f_z	a_p	a_e	TOH
257	0.64	1.4	60	60

Insert geometry test	Tool life
SOHT 120514SR-M:8215	56 min (+35%)

Pramet SSO12 cutters achieved better tool life, beating the competitor by making four workpieces instead of just three!



WMG P3.1

Workpiece: Base plate for wind turbine
Material: 26NiCrMoV11-5 / 1.6948 (360 HB)
Cutter: 63A06R-SMOSO12-C
Coolant: No (just pressed air)

Cutting conditions:				
v_c	f_z	a_p	a_e	TOH
162	1.55	0.65	38	140

Insert geometry test	Tool life
SOHT 120514SR-M:M8330	150 min (+42%)

Pramet SSO12 solution increased tool life to 142% and achieved better surface quality ($R_a 1.0$) than competitor.

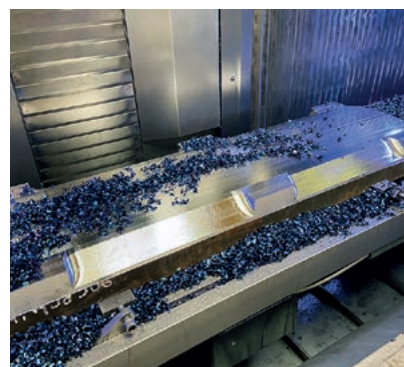

WMG P3.3



SSO12



PRAMET

S



VER S012 12° High Feed Milling with Internal Coolant

Highly versatile 12° high feed mill utilising single sided SO.. 12 style inserts with APMX of 1.9 mm. Suited for a wide range of applications in most workpiece materials. Cylindrical, modular and arbor style available, with differential tooth pitch. Coolant through channels and body treated for longer tool life.

KAPR	12°
APMX	1.9 mm

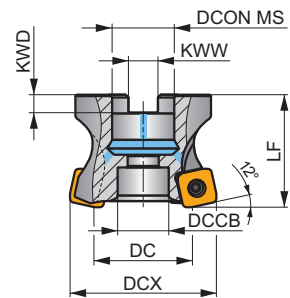
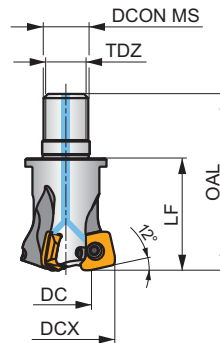
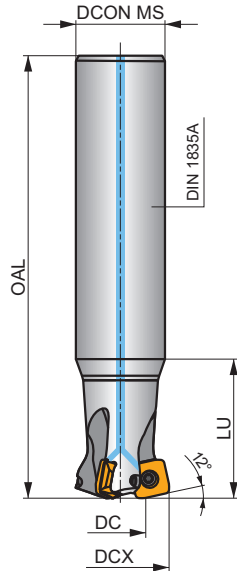
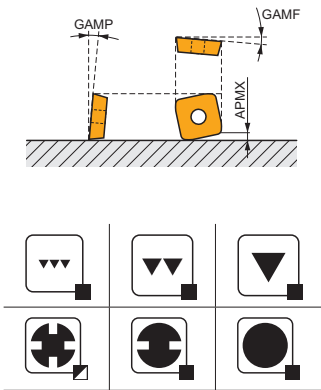

	0.09-0.93
	0.09-0.93



Product	DCX	DC	OAL	DCON MS	DCCB	LU	LF	TDZ	KWW	KWD	GAMF	GAMP	max.	kg	ISO 6462	DIN 8030	AC002	AC003
	(mm)	(mm)	(mm)	(mm)	(mm)	(mm)	(mm)	(mm)	(mm)	(mm)	(°)	(°)						
35E3R050A32-SSO12-C	35	17.3	200	32	-	50	-	-	-	-	-5	5	3	-	15700	✓	1.07	GI350 SQ501 -
35E3R120A32-SSO12-C	35	17.3	200	32	-	120	-	-	-	-	-5	5	3	-	15700	✓	0.95	GI350 SQ501 -
40E4R120A32-SSO12-C	40	22.3	200	32	-	120	-	-	-	-	-5	5	4	-	14700	✓	1.00	GI350 SQ501 -
35E3R040M16-SSO12-C	35	17.3	63	17	-	-	40	M16	-	-	-5	5	3	-	15700	✓	0.15	GI350 SQ501 -
40E4R043M16-SSO12-C	40	22.3	66	17	-	-	43	M16	-	-	-5	5	4	-	14700	✓	0.18	GI350 SQ501 -
42A04R-SMOS012-C	42	24.3	-	16	12.4	-	40	-	8.4	5.6	-5	5	4	-	14300	✓	0.16	GI350 SQ502 -
50A05R-SMOS012-C	50	32.3	-	22	18.1	-	40	-	10.4	6.3	-5	5	5	✓	13100	✓	0.23	GI350 SQ503 -
52A05R-SMOS012-C	52	34.3	-	22	18.1	-	40	-	10.4	6.3	-5	5	5	✓	12800	✓	0.35	GI350 SQ503 -
63A06R-SMOS012-C	63	45.3	-	27	22.1	-	50	-	12.4	7	-5	5	6	✓	11700	✓	0.48	GI350 SQ504 -
66A06R-SMOS012-C	66	48.3	-	27	22.1	-	50	-	12.4	7	-5	5	6	✓	11400	✓	0.51	GI350 SQ504 -
80A07R-SMOS012-C	80	62.3	-	27	22.1	-	50	-	12.4	7	-5	5	7	✓	10400	✓	0.76	GI350 SQ504 -
100A08R-SMOS012-C	100	82.3	-	32	45.1	-	50	-	14.4	8	-5	5	8	✓	9300	✓	1.32	GI350 SQ505 AC002
125A10R-SMOS012-C	125	107.3	-	40	56.1	-	63	-	16.4	9	-5	5	10	✓	8300	✓	2.46	GI350 SQ505 AC003

	GI350		SOHT 1205..
--	-------	--	-------------

		Nm					
SQ501	US 4011-T15P	3.5	M 4	10.6	FLAG T15P	-	-
SQ502	US 4011-T15P	3.5	M 4	10.6	-	SDRT15P-T	HCS 0840C
SQ503	US 4011-T15P	3.5	M 4	10.6	-	SDRT15P-T	HS 1030C
SQ504	US 4011-T15P	3.5	M 4	10.6	-	SDRT15P-T	HS 1230C
SQ505	US 4011-T15P	3.5	M 4	10.6	-	SDRT15P-T	-



AC002	KS 1635	K.FMH32
AC003	KS 2040	K.FMH40

SOHT 12



	IC	D1	S
	(mm)	(mm)	(mm)
1205	12.700	4.50	5.15

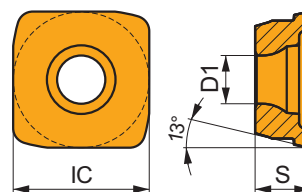

Suitability and starting values for cutting speed (vc), feed (f) and depth of cut (ap). Refer to our Machining Calculator app for further calculations.

Product	Interrupted/ Continuous cut	RE (mm)	P			M			K			N			S			H		
			vc (m/min)	f (mm/tooth)	ap (mm)	vc (m/min)	f (mm/tooth)	ap (mm)	vc (m/min)	f (mm/tooth)	ap (mm)	vc (m/min)	f (mm/tooth)	ap (mm)	vc (m/min)	f (mm/tooth)	ap (mm)	vc (m/min)	f (mm/tooth)	ap (mm)

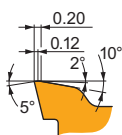

M geometry is versatile for a wide range of working conditions. Designed with positive rake, medium T-land and rounding of cutting edge for smooth HFC milling. First choice for steels, cast irons and hardened steels.

SOHT 120514SR-M:8215	✳	1.4	■	215	1.00	1.0	■	125	0.90	1.0	■	200	1.00	1.0	■	50	0.70	0.8	■	40	0.68	0.8
SOHT 120514SR-M:M8310	✳	1.4	■	225	1.00	1.0	■	110	0.90	1.0	■	210	1.00	1.0	■	—	—	—	■	45	0.68	0.8
SOHT 120514SR-M:M8330	✳	1.4	■	220	1.00	1.0	■	130	0.90	1.0	■	205	1.00	1.0	■	55	0.70	0.8	■	40	0.68	0.8
SOHT 120514SR-M:M8340	✳	1.4	■	205	1.00	1.0	■	120	0.90	1.0	■	190	1.00	1.0	■	50	0.70	0.8	■	—	—	—
SOHT 120514SR-M:M9325	✳	1.4	■	245	1.00	1.0	■	—	—	—	■	230	1.00	1.0	■	—	—	—	■	45	0.68	0.8
SOHT 120514SR-M:M9340	✳	1.4	■	215	1.00	1.0	■	125	0.90	1.0	■	—	—	—	■	50	0.70	0.8	■	—	—	—

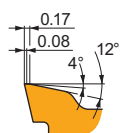

MM geometry is sharp and suitable for large overhang or thin walled and slim workpiece applications. Designed with positive rake, narrow T-land and rounding of cutting edge for smooth HFC milling. First choice for stainless steels and super alloys.

SOHT 120514SR-MM:M6330	✳	1.4	■	190	1.00	1.0	■	135	0.90	1.0	■	—	—	—	■	55	0.70	0.8	■	—	—	—
SOHT 120514SR-MM:M8340	✳	1.4	■	205	1.00	1.0	■	120	0.90	1.0	■	—	—	—	■	50	0.70	0.8	■	—	—	—
SOHT 120514SR-MM:M8345	✳	1.4	■	165	1.00	1.0	■	95	0.90	1.0	■	—	—	—	■	40	0.70	0.8	■	—	—	—
SOHT 120514SR-MM:M9325	✳	1.4	■	245	1.00	1.0	■	—	—	—	■	—	—	—	■	—	—	—	■	—	—	—
SOHT 120514SR-MM:M9340	✳	1.4	■	215	1.00	1.0	■	125	0.90	1.0	■	—	—	—	■	50	0.70	0.8	■	—	—	—



a_e DCX	5%	10%	15%	20%	25%	30%	40%	50%	60%	70%	75%	80%	90%	100%
	1.48	1.35	1.27	1.22	1.19	1.16	1.11	1.08	1.05	1.03	1.00	1.00	1.00	1.00
	2.20	1.60	1.35	1.20	1.10	0.95	0.85	0.75	0.85	0.95	1.00	1.00	1.00	1.00
	0.64	0.64	0.64	0.64	0.64	0.65	0.65	0.67	0.68	0.71	0.72	0.74	0.79	1.00

	SOHT 12-M	SOHT 12-MM
	1.4	1.4
	2.00	2.00

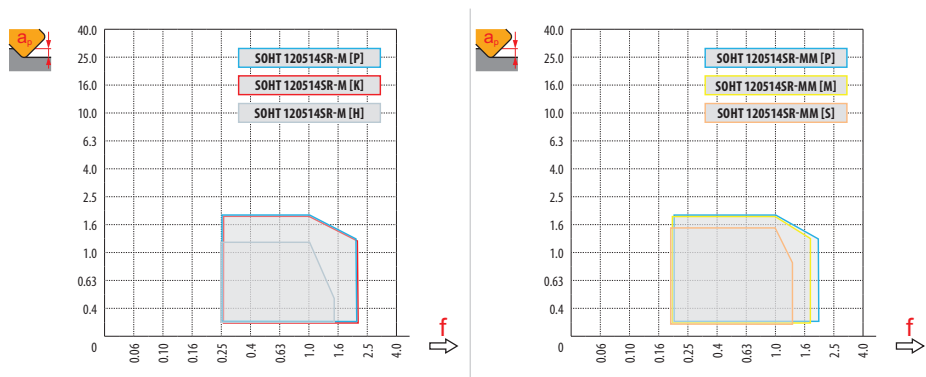

HFC														
		0.00	0.20	0.40	0.60	0.80	1.00	1.20	1.40	1.50	1.60	1.70	1.80	1.90
35		17.3	19.2	21.1	22.9	24.8	26.7	28.6	30.5	31.4	32.4	33.1	33.5	33.9
40		22.3	24.2	26.1	27.9	29.8	31.7	33.6	35.5	36.4	37.4	38.1	38.5	38.9
42		24.3	26.2	28.1	29.9	31.8	33.7	35.6	37.5	38.4	39.4	40.1	40.5	40.9
50		32.3	34.2	36.1	37.9	39.8	41.7	43.6	45.5	46.4	47.4	48.1	48.5	48.9
52		34.3	36.2	38.1	39.9	41.8	43.7	45.6	47.5	48.4	49.4	50.1	50.5	50.9
63		45.3	47.2	49.1	50.9	52.8	54.7	56.6	58.5	59.4	60.4	61.1	61.5	61.9
66		48.3	50.2	52.1	53.9	55.8	57.7	59.6	61.5	62.4	63.4	64.1	64.5	64.9
80		62.3	64.2	66.1	67.9	69.8	71.7	73.6	75.5	76.4	77.4	78.1	78.5	78.9
100		82.3	84.2	86.1	87.9	89.8	91.7	93.6	95.5	96.4	97.4	98.1	98.5	98.9
125		107.3	109.2	111.1	112.9	114.8	116.7	118.6	120.5	121.4	122.4	123.1	123.5	123.9
		0.00	0.20	0.40	0.60	0.80	1.00	1.20	1.40	1.50	1.60	1.70	1.80	1.90
		-	2.20	2.00	1.80	1.60	1.40	1.20	1.10	1.00	0.90	0.80	0.70	0.60

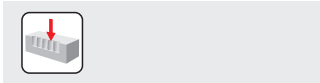

DCX	a_{emax}	f_{max}
35	10.0	0.10
40	10.0	0.10
42	10.0	0.12
50	10.0	0.12
52	10.0	0.12
63	10.0	0.15
66	10.0	0.15
80	10.0	0.20
100	10.0	0.20
125	10.0	0.20

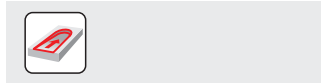

DCX	RPMX	APMX/II
35	9.6	1.9/11
40	6.9	1.9/16
42	6.1	1.9/18
50	4.3	1.9/25
52	4.0	1.9/27
63	2.6	1.9/41
66	2.5	1.9/44
80	1.9	1.9/59
100	1.4	1.9/79
125	1.0	1.9/105

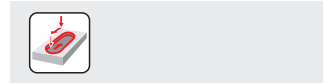

DCX	a_p	f_{max}
35	1.6	0.17
40	1.6	0.17
42	1.6	0.15
50	1.6	0.10
52	1.6	0.10
63	1.6	0.05
66	1.6	0.05
80	1.6	0.05
100	1.6	0.05
125	1.6	0.05



DCX	μm	3	5	10	15	20	30	40	50	60	80	100
35		0.648	0.837	1.183	1.449	1.673	2.049	2.366	2.646	2.898	3.347	3.742
40		0.693	0.894	1.265	1.549	1.789	2.191	2.530	2.828	3.098	3.578	4.000
42		0.710	0.917	1.296	1.587	1.833	2.245	2.592	2.898	3.175	3.666	4.099
50		0.775	1.000	1.414	1.732	2.000	2.449	2.828	3.162	3.464	4.000	4.472
52		0.790	1.020	1.442	1.766	2.040	2.498	2.884	3.225	3.533	4.079	4.561
63		0.869	1.122	1.587	1.944	2.245	2.750	3.175	3.550	3.888	4.490	5.020
66		0.890	1.149	1.625	1.990	2.298	2.814	3.250	3.633	3.980	4.596	5.138
80		0.980	1.265	1.789	2.191	2.530	3.098	3.578	4.000	4.382	5.060	5.657
100		1.095	1.414	2.000	2.449	2.828	3.464	4.000	4.472	4.899	5.657	6.325
125		1.225	1.581	2.236	2.739	3.162	3.873	4.472	5.000	5.477	6.325	7.071



a_p	0.2	0.6	1.0	1.5	1.9
f	2.0	1.6	1.2	0.8	0.5



DCX	D _{MIN}	D _{MAX}	S _{MAX} D _{MIN}	S _{MAX} D _{MAX}
35	46.0	69.8	1.9	1.9
40	56.0	79.8	1.9	1.9
42	60.0	83.8	1.9	1.9
50	76.0	99.8	1.9	1.9
52	80.0	103.8	1.9	1.9
63	102.0	125.8	1.9	1.9
66	108.0	131.8	1.9	1.9
80	136.0	159.8	1.9	1.9
100	176.0	199.8	1.9	1.9
125	226.0	249.8	1.9	1.9



SOHT	R	T
SOHT 120514	3.37	1.21



E559

ECONOMICAL HAND AND SERIAL TAPS

INTRODUCTION



Introducing the Dormer E559 series, a fresh line of cost-effective hand and serial taps. The reliable tapping design ensures a smooth cutting action and efficient chip evacuation. Our extensive selection includes the most popular M, MF, UNC and UNF thread forms, available in a wide range of sizes. The Dormer E559 is the right economical choice for maintenance mechanics, field service engineers, craftspeople, contract engineers, and educational institutions.



EXPLANATION HAND TAPS

- + Hand taps cut always a full thread profile
- + Any tap lead can be used for tapping in through holes
- Limitations on usable thread lengths in blind holes



E559N01

- Taper lead



E599N02

- Plug lead



E559N03

- Bottoming lead (Finishing tap)





THREADING TOOLS

HAND TAPS OVERVIEW

Straight Flute Taper Lead Hand Tap, ISO Standard

Versatile tap design for hand use or machine tapping in medium strength, medium carbon and alloy steel. With a taper lead chamfer which produces the thinnest chips providing a very gradual and smooth cutting action. Considered to be the best choice for producing short through holes up to 1.5xD.

E559NO1(M)

- Metric range: M3 – M20



E559NO1(MF)

- Metric-fine range: M8×1 – M16×1.5



E559NO1(UNC)

- UNC range: No. 10-24 – 1/2"



E559NO1(UNF)

- UNF range: No. 10-32 – 1/2"-20

Straight Flute Plug Lead Hand Tap, ISO Standard

Versatile tap design for hand use or machine tapping in medium strength, medium carbon and alloy steel. With a plug lead chamfer which gives the tap a gradual cutting action. Great for producing through holes, as they are almost as easy as taper lead taps to start, yet also offer a more complete set of threads.



E559NO2(M)

- Metric range: M3 – M20



E559NO2(MF)

- Metric-fine range: M8×1 – M16×1.5



E559NO2(UNC)

- UNC range: No. 10-24 – 1/2"





E559NO2(UNF)

- UNF range: No. 10-32 – 1/2"-20

Straight Flute Bottoming Lead Hand Tap, ISO Standard

Versatile tap for medium strength carbon and alloy steel. With bottoming lead, which though it is hard to start threading with is capable of cutting thread almost all of the way to the bottom of a blind hole. Best used as machine tap or if by hand in sequence after taper and plug lead or starter and intermediate serial tap.

E559NO3(M)

- Metric range: M3 – M20



E559-NO3(MF)

- Metric-fine range: M8×1 – M16×1.5



E559-NO3(UNC)

- UNC range: No. 10-24 – 1/2"



E559-NO3(UNF)

- UNF range: No. 10-32 – 1/2"-20



Set of 3 Straight Flute Hand Taps, ISO Standard

The most versatile taps for hand use or machine tapping through or blind holes in medium strength, medium carbon and alloy steel. Set including taps with 3 different chamfer lengths; taper lead which is ideally for short through holes, plug perfect for deeper through holes and bottoming best suited for blind holes.



E559NO6(M)

- Metric range: M3 – M20

E559NO6(MF)

- Metric-fine range: M8×1 – M16×1.5



E559NO6(UNC)

- UNC range: No. 10-24 – 1/2"





E559NO6(UNF)

- UNF range: No. 10-32 – 1/2"-20

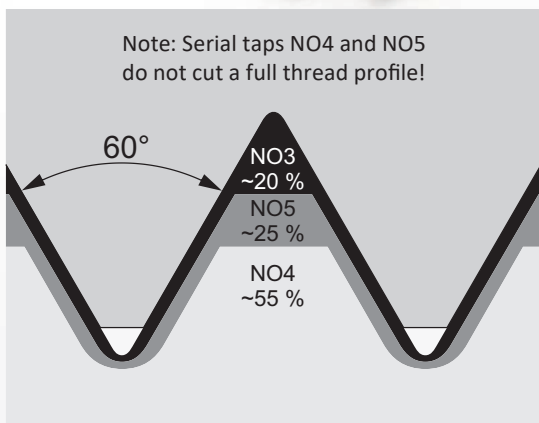

E559

ECONOMICAL HAND AND SERIAL TAPS



EXPLANATION SERIAL TAPS

- + This set of serial taps requires lower cutting force, ideal to use with wrench.
- + This set of serial taps can be a problem solver for harder materials tapping.
- Serial taps always need to be used in sequence from NO4 to NO3.



E559NO4

- Starter tap



E559NO5

- Seconding tap



E559NO3

- Finishing tap (Bottoming lead)



THREADING TOOLS

SERIAL TAPS OVERVIEW

Set of 3 Straight Flute Serial Hand Taps, ISO Standard

Ideal for hand tapping tough materials. The straight flute design makes it suitable for both through and blind holes. Set of 3 taps to be used in sequence, first the starter tap to make a roughing cut, second the intermediate to cut the thread a little fuller and third the finisher for smoothing the thread and making it exact.



Set of 2 Straight Flute Serial Hand Taps, ISO Standard

Ideal for hand tapping tough materials. The straight flute design makes it suitable for both through and blind holes. Set of 2 taps to be used in sequence, first the starter tap to make a roughing cut and a finisher for smoothing the thread and making it exact.





A113

BRIGHT HSS DRILL

INTRODUCTION



Introducing cost effective general purpose HSS jobber drill with bright finish – Dormer A113. Conventional 118° point provides strength, while bright finish improves chip flow and its evacuation, especially in soft, sticky ferrous alloys and non-ferrous alloys. Easy multiple regrinding brings added value for maintenance mechanics, field service engineers, craftspeople, contract engineers, and educational institutions.

 **DORMER**



A113



- HSS Jobber drill
- Bright finish
- Metric range: 0.8 – 14 mm
- Imperial range: 3/64 – 35/64"



A113



HSS Jobber Drill, Bright Finish

A versatile all-around drill with a 118° conventional point, which provides strength and is easy to regrind, making it very cost-effective for general purpose applications. Usable for hand-held and machine drilling. Bright finish improves chip flow in soft ferrous or non-ferrous materials.

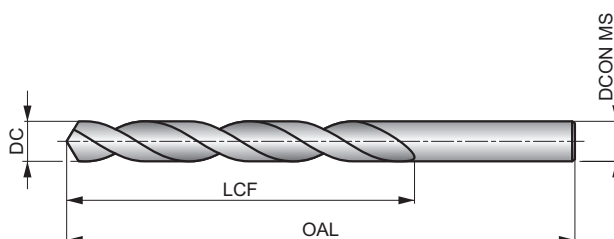

HSS	DIN 338	4xD
118°	Bright	
λ 20-35°	R	DC h8

Workpiece material group suitability, starting values for cutting speed (m/min) and feed Alpha Code. Tables with feed per revolution can be found starting from page XY.

P1.1 ■ 29 H	P1.2 ■ 33 H	P1.3 ■ 33 H	P2.1 ■ 25 H	P2.2 ■ 22 F	P2.3 ■ 19 E	K1.1 ■ 26 H	K1.2 ■ 19 F	K1.3 ■ 15 F	K2.1 ■ 22 E	K2.2 ■ 18 E	K2.3 ■ 14 E	N1.1 ■ 29 J	N1.2 ■ 22 J
N1.3 ■ 15 I	N2.1 ■ 37 H	N2.2 ■ 33 H	N2.3 ■ 24 H	N3.1 ■ 52 H	N3.2 ■ 31 I	N3.3 ■ 16 G							

Product	DC	DC	DC	LCF	OAL	DCON MS
	(inch)	(mm)	(inch)	(mm)	(mm)	(mm)
A113.8	–	0.80	0.0315	10.0	30.0	0.80
A113.9	–	0.90	0.0354	11.0	32.0	0.90
A1131.0	–	1.00	0.0394	12.0	34.0	1.00
A113N60	N60	1.02	0.0402	12.0	34.0	1.02
A1131.05	–	1.05	0.0413	12.0	34.0	1.05
A113N57	N57	1.09	0.0429	14.0	36.0	1.09
A1131.1	–	1.10	0.0433	14.0	36.0	1.10
A113N56	N56	1.18	0.0465	14.0	36.0	1.18
A1133/64	3/64	1.19	0.0469	16.0	38.0	1.19
A1131.2	–	1.20	0.0472	16.0	38.0	1.20
A1131.3	–	1.30	0.0512	16.0	38.0	1.30
A113N55	N55	1.32	0.0520	16.0	38.0	1.32
A1131.35	–	1.35	0.0531	18.0	40.0	1.35
A1131.4	–	1.40	0.0551	18.0	40.0	1.40
A1131.5	–	1.50	0.0591	18.0	40.0	1.50
A113N53	N53	1.51	0.0594	20.0	43.0	1.51
A1131.55	–	1.55	0.0610	20.0	43.0	1.55
A1131/16	1/16	1.59	0.0625	20.0	43.0	1.59
A1131.6	–	1.60	0.0630	20.0	43.0	1.60
A113N52	N52	1.61	0.0634	20.0	43.0	1.61
A1131.65	–	1.65	0.0650	20.0	43.0	1.65
A1131.7	–	1.70	0.0669	20.0	43.0	1.70
A113N50	N50	1.78	0.0701	22.0	46.0	1.78
A1131.8	–	1.80	0.0709	22.0	46.0	1.80
A113N49	N49	1.85	0.0728	22.0	46.0	1.85
A1131.9	–	1.90	0.0748	22.0	46.0	1.90
A113N48	N48	1.93	0.0760	24.0	49.0	1.93
A1131.95	–	1.95	0.0768	24.0	49.0	1.95
A1135/64	5/64	1.98	0.0781	24.0	49.0	1.98
A1132.0	–	2.00	0.0787	24.0	49.0	2.00

Product	DC	DC	DC	LCF	OAL	DCON MS
	(inch)	(mm)	(inch)	(mm)	(mm)	(mm)
A113N46	N46	2.06	0.0811	24.0	49.0	2.06
A1132.1	–	2.10	0.0827	24.0	49.0	2.10
A113N44	N44	2.18	0.0858	27.0	53.0	2.18
A1132.2	–	2.20	0.0866	27.0	53.0	2.20
A113N43	N43	2.26	0.0890	27.0	53.0	2.26
A1132.3	–	2.30	0.0906	27.0	53.0	2.30
A113N42	N42	2.37	0.0933	30.0	57.0	2.37
A1133/32	3/32	2.38	0.0938	30.0	57.0	2.38
A1132.4	–	2.40	0.0945	30.0	57.0	2.40
A113N41	N41	2.44	0.0961	30.0	57.0	2.44
A1132.5	–	2.50	0.0984	30.0	57.0	2.50
A113N39	N39	2.53	0.0996	30.0	57.0	2.53
A1132.55	–	2.55	0.1004	30.0	57.0	2.55
A1132.6	–	2.60	0.1024	30.0	57.0	2.60
A113N37	N37	2.64	0.1039	30.0	57.0	2.64
A1132.7	–	2.70	0.1063	33.0	61.0	2.70
A113N36	N36	2.71	0.1067	33.0	61.0	2.71
A1132.75	–	2.75	0.1083	33.0	61.0	2.75
A1137/64	7/64	2.78	0.1094	33.0	61.0	2.78
A1132.8	–	2.80	0.1102	33.0	61.0	2.80
A113N34	N34	2.82	0.1110	33.0	61.0	2.82
A113N33	N33	2.87	0.1130	33.0	61.0	2.87
A1132.9	–	2.90	0.1142	33.0	61.0	2.90
A113N32	N32	2.95	0.1161	33.0	61.0	2.95
A1133.0	–	3.00	0.1181	33.0	61.0	3.00
A113N31	N31	3.05	0.1201	36.0	65.0	3.05
A1133.1	–	3.10	0.1220	36.0	65.0	3.10
A1131/8	1/8	3.17	0.1250	36.0	65.0	3.17
A1133.2	–	3.20	0.1260	36.0	65.0	3.20
A1133.25	–	3.25	0.1280	36.0	65.0	3.25



Product	DC	DC	DC	LCF	OAL	D CON MS
	(inch)	(mm)	(inch)	(mm)	(mm)	(mm)
A113N30	N30	3.26	0.1283	36.0	65.0	3.26
A1133.3	–	3.30	0.1299	36.0	65.0	3.30
A1133.4	–	3.40	0.1339	39.0	70.0	3.40
A113N29	N29	3.45	0.1358	39.0	70.0	3.45
A1133.5	–	3.50	0.1378	39.0	70.0	3.50
A1139/64	9/64	3.57	0.1406	39.0	70.0	3.57
A1133.6	–	3.60	0.1417	39.0	70.0	3.60
A1133.7	–	3.70	0.1457	39.0	70.0	3.70
A113N26	N26	3.73	0.1469	39.0	70.0	3.73
A113N25	N25	3.80	0.1496	43.0	75.0	3.80
A1133.8	–	3.80	0.1496	43.0	75.0	3.80
A113N24	N24	3.86	0.1520	43.0	75.0	3.86
A1133.9	–	3.90	0.1535	43.0	75.0	3.90
A113N23	N23	3.91	0.1539	43.0	75.0	3.91
A1133.95	–	3.95	0.1555	43.0	75.0	3.95
A1135/32	5/32	3.97	0.1563	43.0	75.0	3.97
A113N22	N22	3.99	0.1571	43.0	75.0	3.99
A1134.0	–	4.00	0.1575	43.0	75.0	4.00
A113N21	N21	4.04	0.1591	43.0	75.0	4.04
A1134.05	–	4.05	0.1594	43.0	75.0	4.05
A113N20	N20	4.09	0.1610	43.0	75.0	4.09
A1134.1	–	4.10	0.1614	43.0	75.0	4.10
A1134.15	–	4.15	0.1634	43.0	75.0	4.15
A1134.2	–	4.20	0.1654	43.0	75.0	4.20
A1134.25	–	4.25	0.1673	43.0	75.0	4.25
A1134.3	–	4.30	0.1693	47.0	80.0	4.30
A11311/64	11/64	4.37	0.1719	47.0	80.0	4.37
A1134.4	–	4.40	0.1732	47.0	80.0	4.40
A1134.5	–	4.50	0.1772	47.0	80.0	4.50
A1134.6	–	4.60	0.1811	47.0	80.0	4.60
A1134.7	–	4.70	0.1850	47.0	80.0	4.70
A1133/16	3/16	4.76	0.1875	52.0	86.0	4.76
A1134.8	–	4.80	0.1890	52.0	86.0	4.80
A113N11	N11	4.85	0.1909	52.0	86.0	4.85
A1134.9	–	4.90	0.1929	52.0	86.0	4.90
A113N10	N10	4.92	0.1937	52.0	86.0	4.92
A1134.95	–	4.95	0.1949	52.0	86.0	4.95
A1135.0	–	5.00	0.1969	52.0	86.0	5.00
A113N8	N8	5.06	0.1992	52.0	86.0	5.06
A1135.1	–	5.10	0.2008	52.0	86.0	5.10
A11313/64	13/64	5.16	0.2031	52.0	86.0	5.16
A1135.2	–	5.20	0.2047	52.0	86.0	5.20
A1135.3	–	5.30	0.2087	52.0	86.0	5.30
A1135.4	–	5.40	0.2126	57.0	93.0	5.40
A1135.5	–	5.50	0.2165	57.0	93.0	5.50
A1137/32	7/32	5.56	0.2188	57.0	93.0	5.56
A1135.6	–	5.60	0.2205	57.0	93.0	5.60
A1135.7	–	5.70	0.2244	57.0	93.0	5.70
A1135.8	–	5.80	0.2283	57.0	93.0	5.80
A1135.9	–	5.90	0.2323	57.0	93.0	5.90
A11315/64	15/64	5.95	0.2344	57.0	93.0	5.95
A1136.0	–	6.00	0.2362	57.0	93.0	6.00
A113B	B	6.04	0.2378	63.0	101.0	6.04
A1136.1	–	6.10	0.2402	63.0	101.0	6.10
A1136.2	–	6.20	0.2441	63.0	101.0	6.20
A1136.3	–	6.30	0.2480	63.0	101.0	6.30
A1131/4	1/4	6.35	0.2500	63.0	101.0	6.35
A1136.4	–	6.40	0.2520	63.0	101.0	6.40
A1136.5	–	6.50	0.2559	63.0	101.0	6.50
A1136.6	–	6.60	0.2598	63.0	101.0	6.60
A113G	G	6.63	0.2610	63.0	101.0	6.63
A1136.7	–	6.70	0.2638	63.0	101.0	6.70

Product	DC	DC	DC	LCF	OAL	D CON MS
	(inch)	(mm)	(inch)	(mm)	(mm)	(mm)
A11317/64	17/64	6.75	0.2656	69.0	109.0	6.75
A1136.8	–	6.80	0.2677	69.0	109.0	6.80
A1136.9	–	6.90	0.2717	69.0	109.0	6.90
A1137.0	–	7.00	0.2756	69.0	109.0	7.00
A1137.1	–	7.10	0.2795	69.0	109.0	7.10
A1139/32	9/32	7.14	0.2813	69.0	109.0	7.14
A1137.2	–	7.20	0.2835	69.0	109.0	7.20
A1137.3	–	7.30	0.2874	69.0	109.0	7.30
A1137.4	–	7.40	0.2913	69.0	109.0	7.40
A1137.5	–	7.50	0.2953	69.0	109.0	7.50
A11319/64	19/64	7.54	0.2969	75.0	117.0	7.54
A1137.6	–	7.60	0.2992	75.0	117.0	7.60
A1137.7	–	7.70	0.3031	75.0	117.0	7.70
A1137.8	–	7.80	0.3071	75.0	117.0	7.80
A1137.9	–	7.90	0.3110	75.0	117.0	7.90
A1135/16	5/16	7.94	0.3125	75.0	117.0	7.94
A1138.0	–	8.00	0.3150	75.0	117.0	8.00
A1138.1	–	8.10	0.3189	75.0	117.0	8.10
A1138.2	–	8.20	0.3228	75.0	117.0	8.20
A1138.3	–	8.30	0.3268	75.0	117.0	8.30
A11321/64	21/64	8.33	0.3281	75.0	117.0	8.33
A1138.4	–	8.40	0.3307	75.0	117.0	8.40
A1138.5	–	8.50	0.3346	75.0	117.0	8.50
A1138.6	–	8.60	0.3386	81.0	125.0	8.60
A1138.7	–	8.70	0.3425	81.0	125.0	8.70
A11311/32	11/32	8.73	0.3438	81.0	125.0	8.73
A1138.8	–	8.80	0.3465	81.0	125.0	8.80
A1135	S	8.84	0.3480	81.0	125.0	8.84
A1138.9	–	8.90	0.3504	81.0	125.0	8.90
A1139.0	–	9.00	0.3543	81.0	125.0	9.00
A1139.1	–	9.10	0.3583	81.0	125.0	9.10
A11323/64	23/64	9.13	0.3594	81.0	125.0	9.13
A1139.2	–	9.20	0.3622	81.0	125.0	9.20
A1139.3	–	9.30	0.3661	81.0	125.0	9.30
A113U	U	9.34	0.3677	81.0	125.0	9.34
A1139.4	–	9.40	0.3701	81.0	125.0	9.40
A1139.5	–	9.50	0.3740	81.0	125.0	9.50
A1133/8	3/8	9.53	0.3750	87.0	133.0	9.53
A1139.6	–	9.60	0.3780	87.0	133.0	9.60
A1139.7	–	9.70	0.3819	87.0	133.0	9.70
A1139.8	–	9.80	0.3858	87.0	133.0	9.80
A1139.9	–	9.90	0.3898	87.0	133.0	9.90
A11325/64	25/64	9.92	0.3906	87.0	133.0	9.92
A11310.0	–	10.00	0.3937	87.0	133.0	10.00
A11310.1	–	10.10	0.3976	87.0	133.0	10.10
A11310.2	–	10.20	0.4016	87.0	133.0	10.20
A11310.3	–	10.30	0.4055	87.0	133.0	10.30
A11313/32	13/32	10.32	0.4063	87.0	133.0	10.32
A11310.4	–	10.40	0.4094	87.0	133.0	10.40
A11310.5	–	10.50	0.4134	87.0	133.0	10.50
A11310.6	–	10.60	0.4173	87.0	133.0	10.60
A11310.7	–	10.70	0.4213	94.0	142.0	10.70
A11327/64	27/64	10.72	0.4219	94.0	142.0	10.72
A11310.8	–	10.80	0.4252	94.0	142.0	10.80
A11310.9	–	10.90	0.4291	94.0	142.0	10.90
A11311.0	–	11.00	0.4331	94.0	142.0	11.00
A11311.1	–	11.10	0.4370	94.0	142.0	11.10
A1137/16	7/16	11.11	0.4375	94.0	142.0	11.11
A11311.2	–	11.20	0.4409	94.0	142.0	11.20
A11311.3	–	11.30	0.4449	94.0	142.0	11.30
A11311.4	–	11.40	0.4488	94.0	142.0	11.40
A11311.5	–	11.50	0.4528	94.0	142.0	11.50



Product	DC	DC	DC	LCF	OAL	DCON MS
	(inch)	(mm)	(inch)	(mm)	(mm)	(mm)
A11329/64	29/64	11.51	0.4531	94.0	142.0	11.51
A11311.6	–	11.60	0.4567	94.0	142.0	11.60
A11311.7	–	11.70	0.4606	94.0	142.0	11.70
A11311.8	–	11.80	0.4646	94.0	142.0	11.80
A11311.9	–	11.90	0.4685	101.0	151.0	11.90
A11315/32	15/32	11.91	0.4688	101.0	151.0	11.91
A11312.0	–	12.00	0.4724	101.0	151.0	12.00
A11312.1	–	12.10	0.4764	101.0	151.0	12.10
A11312.2	–	12.20	0.4803	101.0	151.0	12.20
A11312.3	–	12.30	0.4843	101.0	151.0	12.30
A11331/64	31/64	12.30	0.4844	101.0	151.0	12.30
A11312.4	–	12.40	0.4882	101.0	151.0	12.40
A11312.5	–	12.50	0.4921	101.0	151.0	12.50
A11312.6	–	12.60	0.4961	101.0	151.0	12.60
A1131/2	1/2	12.70	0.5000	101.0	151.0	12.70
A11312.7	–	12.70	0.5000	101.0	151.0	12.70

Product	DC	DC	DC	LCF	OAL	DCON MS
	(inch)	(mm)	(inch)	(mm)	(mm)	(mm)
A11312.8	–	12.80	0.5039	101.0	151.0	12.80
A11312.9	–	12.90	0.5079	101.0	151.0	12.90
A11313.0	–	13.00	0.5118	101.0	151.0	13.00
A11333/64	33/64	13.10	0.5156	101.0	151.0	13.10
A11313.1	–	13.10	0.5157	101.0	151.0	13.10
A11313.2	–	13.20	0.5197	101.0	151.0	13.20
A11313.3	–	13.30	0.5236	108.0	160.0	13.30
A11313.4	–	13.40	0.5276	108.0	160.0	13.40
A11317/32	17/32	13.49	0.5313	108.0	160.0	13.49
A11313.5	–	13.50	0.5315	108.0	160.0	13.50
A11313.6	–	13.60	0.5354	108.0	160.0	13.60
A11313.7	–	13.70	0.5394	108.0	160.0	13.70
A11313.8	–	13.80	0.5433	108.0	160.0	13.80
A11335/64	35/64	13.89	0.5469	108.0	160.0	13.89
A11313.9	–	13.90	0.5472	108.0	160.0	13.90
A11314.0	–	14.00	0.5512	108.0	160.0	14.00



TOOL BITS

HSS-E TOOL BITS

INTRODUCTION



Presenting comprehensive range of Dormer turning tool bits. Made from T2000S HSS-E bright steel with a 10% Cobalt content, ground in accordance with DIN 4964 standards. These tools achieve a robust hardness level of 65 – 67 HRC, ensuring precise and reliable turning performance.



F

- HSS-E
- Rectangular Tool bit
- Metric range:
8 × 6 – 30 × 20 mm



R

- HSS-E
- Round Tool bit
- Metric range:
D3 – D20 mm



S

- HSS-E
- Square Tool bit
- Metric range:
4 × 4 – 25 × 25 mm



SA

- HSS-E
- Square Tool bit with Bevel
- Metric range:
4 × 4 – 25 × 25 mm
- Imperial range:
3/16 × 3/16 – 5/8 × 5/8



TOOL BITS F

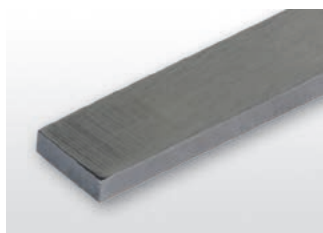

HSS-E Rectangular Tool bit

Ground rectangular tool bit according to DIN 4964 D standard. T2000S HSS-E bright steel with 10% Cobalt content in hardness 65 – 67 HRC.



HSS-E	DIN 4964D	Bright
h13		

Product	H (mm)	B (mm)	OAL (mm)
8X6X200:T2000S	8	6	200.0
10X2X200:T2000S	10	2	200.0
10X3X200:T2000S	10	3	200.0
10X4X200:T2000S	10	4	200.0
10X5X200:T2000S	10	5	200.0
10X6X200:T2000S	10	6	200.0
10X8X200:T2000S	10	8	200.0
12X3X200:T2000S	12	3	200.0
12X4X200:T2000S	12	4	200.0
12X6X200:T2000S	12	6	200.0
12X8X200:T2000S	12	8	200.0
15X3X200:T2000S	15	3	200.0
15X4X200:T2000S	15	4	200.0
15X5X200:T2000S	15	5	200.0
15X6X200:T2000S	15	6	200.0
15X8X200:T2000S	15	8	200.0
15X10X200:T2000S	15	10	200.0
16X8X200:T2000S	16	8	200.0
16X10X200:T2000S	16	10	200.0

Product	H (mm)	B (mm)	OAL (mm)
16X12X200:T2000S	16	12	200.0
20X3X200:T2000S	20	3	200.0
20X4X200:T2000S	20	4	200.0
20X5X200:T2000S	20	5	200.0
20X6X200:T2000S	20	6	200.0
20X8X200:T2000S	20	8	200.0
20X10X200:T2000S	20	10	200.0
20X12X200:T2000S	20	12	200.0
20X15X200:T2000S	20	15	200.0
25X5X200:T2000S	25	5	200.0
25X6X200:T2000S	25	6	200.0
25X10X200:T2000S	25	10	200.0
25X12X200:T2000S	25	12	200.0
30X4X200:T2000S	30	4	200.0
30X5X200:T2000S	30	5	200.0
30X10X200:T2000S	30	10	200.0
30X15X200:T2000S	30	15	200.0
30X20X200:T2000S	30	20	200.0



TOOL BITS R

DORMER



HSS-E Round Tool bit

Ground round tool bit according to DIN 4964 A standard. T2000S HSS-E bright steel with 10% Cobalt content in hardness 65 – 67 HRC.



HSS-E	DIN 4964A	Bright
h9		

Product	DCON MS		OAL
	(mm)		(mm)
3X200 T:T2000S	3.00		200.0
4X200 T:T2000S	4.00		200.0
5X200 T:T2000S	5.00		200.0
6X200 T:T2000S	6.00		200.0
7X200 T:T2000S	7.00		200.0
8X200 T:T2000S	8.00		200.0
10X200 T:T2000S	10.00		200.0
12X200 T:T2000S	12.00		200.0
14X200 T:T2000S	14.00		200.0
16X200 T:T2000S	16.00		200.0
20X200 T:T2000S	20.00		200.0



TOOL BITS S



HSS-E Square Tool bit

Ground square tool bit according to DIN 4964 B standard. T2000S HSS-E bright steel with 10% Cobalt content in hardness 65 – 67 HRC.

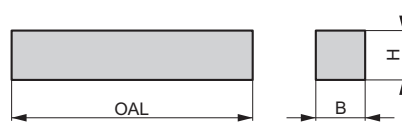

HSS-E	DIN 4964B	Bright
+0 -0.1		

Product	H (mm)	B (mm)	OAL (mm)
4X4X200:T2000S	4	4	200.0
6X6X200:T2000S	6	6	200.0
8X8X200:T2000S	8	8	200.0
10X10X200:T2000S	10	10	200.0
12X12X200:T2000S	12	12	200.0
14X14X200:T2000S	14	14	200.0
15X15X200:T2000S	15	15	200.0
16X16X200:T2000S	16	16	200.0
20X20X200:T2000S	20	20	200.0
25X25X200:T2000S	25	25	200.0



TOOL BITS SA

DORMER

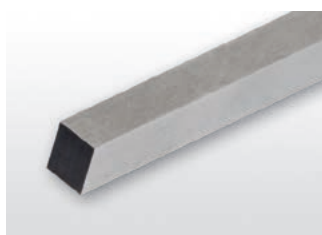

HSS-E Square Tool bit with Bevel

Ground square tool bit with beveled ends according to DIN 4964 B standard. T2000S HSS-E bright steel with 10% Cobalt content in hardness 65 – 67 HRC.

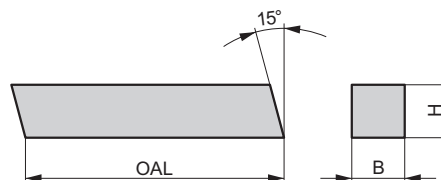

HSS-E	DIN 4964B	Bright
h13		

Product	H	B	OAL	H	B	OAL
	(mm)	(mm)	(mm)	(inch)	(inch)	(inch)
4X4X200A:T2000S	4	4	200.0	–	–	–
6X6X100A:T2000S	6	6	100.0	–	–	–
6X6X200A:T2000S	6	6	200.0	–	–	–
8X8X100A:T2000S	8	8	100.0	–	–	–
8X8X160A:T2000S	8	8	160.0	–	–	–
8X8X200A:T2000S	8	8	200.0	–	–	–
10X10X100A:T2000S	10	10	100.0	–	–	–
10X10X160A:T2000S	10	10	160.0	–	–	–
10X10X200A:T2000S	10	10	200.0	–	–	–
12X12X100A:T2000S	12	12	100.0	–	–	–
12X12X200A:T2000S	12	12	200.0	–	–	–
14X14X200A:T2000S	14	14	200.0	–	–	–
15X15X200A:T2000S	15	15	200.0	–	–	–
16X16X200A:T2000S	16	16	200.0	–	–	–
20X20X200A:T2000S	20	20	200.0	–	–	–
25X25X200A:T2000S	25	25	200.0	–	–	–
3/16X3/16X2.1/2A:T2000S	–	–	–	3/16	3/16	2.500
1/4X1/4X2.1/2A:T2000S	–	–	–	1/4	1/4	2.500
1/4X1/4X4A:T2000S	–	–	–	1/4	1/4	4.000
5/16X5/16X2.1/2A:T2000S	–	–	–	5/16	5/16	2.500
5/16X5/16X4A:T2000S	–	–	–	5/16	5/16	4.000
3/8X3/8X3A:T2000S	–	–	–	3/8	3/8	3.000
3/8X3/8X4A:T2000S	–	–	–	3/8	3/8	4.000
3/8X3/8X6A:T2000S	–	–	–	3/8	3/8	6.000
1/2X1/2X4A:T2000S	–	–	–	1/2	1/2	4.000
1/2X1/2X6A:T2000S	–	–	–	1/2	1/2	6.000
5/8X5/8X6A:T2000S	–	–	–	5/8	5/8	6.000











TECHNICAL INFORMATION



CORRECTION FACTORS – TURNING

Correction factors for specific type of operation C_{VcO}

  															
	0.5			1.5			2.5			5.0			12.0		
	I	II	III	I	II	III	I	II	III	I	II	III	I	II	III
	0.05	0.08	0.10	0.10	0.15	0.20	0.20	0.30	0.40	0.40	0.60	0.80	0.80	1.00	1.30
Chip-breakers for fine finishing (FF, FF2...)	1.15	1.00	0.95	0.85	0.80	–	–	–	–	–	–	–	–	–	–
Chip-breakers for finishing (NF, SF...)	–	–	1.20	1.05	1.00	1.05	1.00	0.90	–	–	–	–	–	–	–
Chip-breakers for medium machining (FM, M, NM, NMR, SM...)	–	–	–	–	–	1.15	1.10	1.00	0.95	0.85	–	–	–	–	–
Chip-breakers for roughing (RM, NRM, NR, R...)	–	–	–	–	–	–	–	–	1.25	1.10	1.00	0.95	0.65	–	–
Chip-breakers for heavy roughing (HR, HR2, NR2, OR...) for 45 min durability	–	–	–	–	–	–	–	–	–	1.25	1.20	1.15	1.05	1.00	0.95

Correction factors for required durability C_{VcT}

	minutes	10	15	20	30	45	60
General machining operations (fine finishing up to roughing)		1.13	1.00	0.93	0.84	0.76	0.71
Heavy machining operations (heavy roughing)		–	–	–	1.10	1.00	0.93

Additional correction factors C_{VcA}

Machining environment	C_{VcA}
Condition of the work-material (hard skin due to forging or casting)	0.70
Internal turning	0.75
Parting and grooving (radial)	0.88
Face grooving	0.80
Interrupted cut	0.80
Unstable machining conditions	0.85
Common machining conditions	1.00
Stable machining conditions	1.20

Resulting corrected cutting speed v_{cc}

$$v_{cc} = v_c \times k_{VG} \times C_{VcO} \times C_{VcT} \times C_{VcA}$$

v_c – starting speed from catalogue page

k_{VG} – coefficient of used material



CORRECTION FACTORS – INDEXABLE MILLS

Correction factors for specific type of cutter and operation C_{VCO}

			
Face mills with <i>KAPR</i> 45° – 60° and negative inserts (SHN06C, SHN09C, CHN09, ...)	1.15	1.00	0.85
Face mills with <i>KAPR</i> 45° and positive inserts (SOE06Z, SOE09Z, SOD05, ...)	1.15	1.00	0.85
Shoulder mills with <i>KAPR</i> 90° (SAD07D, SAD11E, SAD16E, SLN12, SLN16..)	1.10	1.00	0.90
Copy face mills (SRC10 – SRC20, SRD05 – SRD16, ...)	1.10	1.00	0.90
Copy end mills (K2-PPH, K2-SLC, K2-SRC, K3-CXP...)	1.10	1.00	0.90
Disc mills (S90CN(XN), S90SN...)	1.10	1.00	0.90
Shoulder mills with extended flute J(T)-CSD12X, J(T)-SAD11E, J(T)-SAD16E...)	1.25	1.00	0.80
Face mills for heavy duty (FSB22X, SPN13..)	1.30	1.00	0.85
Shoulder mills for heavy duty (FTB27X..)	1.25	1.00	0.85

Correction factors for required durability C_{VCT}

	minutes	15	20	30	45	60	90	120
General machining operations (fine finishing up to roughing)		1.23	1.13	1.00	0.89	0.81	0.72	–
Heavy machining operations (heavy roughing)		–	–	1.23	1.13	1.00	0.89	0.81

Additional correction factors C_{VCA}

Machining environment	C_{VCA}
Condition of the work-material (hard skin due to forging or casting)	0.70
Unstable machining conditions	0.85
Common machining conditions	1.00
Stable machining conditions	1.20

Correction factors for cutting speed when face and shoulder milling with < 100 % radial immersion C_{VCRCT}

$\frac{a_p}{DC}$	5 %	10 %	15 %	20 %	25 %	30 %	40 %	50 %	60 %	70 %	75 %	80 %	90 %	100 %
	1.48	1.35	1.27	1.22	1.19	1.16	1.11	1.08	1.05	1.03	1.00	1.00	1.00	1.00

Resulting corrected cutting speed v_{CC}

$$v_{CC} = v_c \times k_{VG} \times C_{VCO} \times C_{VCT} \times C_{VCA} \times C_{fzRCT}$$

v_c – starting speed from catalogue page

k_{VG} – coefficient of used material



WMG (WORK MATERIAL GROUP)

ISO group	WMG (Work Material Group)	Hardness (HB or HRC)	Ultimate Tensile Strength (MPa)	Correction factor kvG			
P	P1	P1.1	Sulfurized	< 240 HB	≤ 830	1.33	
		P1.2	Free machining steel	Sulfurized and phosphorized	< 180 HB	≤ 620	1.49
		P1.3	(carbon steels with increased machinability)	Sulfurized/phosphorized and leaded	< 180 HB	≤ 620	1.53
	P2	P2.1	Plain carbon steel (steels comprised of mainly iron and carbon)	Containing < 0.25 % C	< 180 HB	≤ 620	1.14
		P2.2		Containing < 0.55 % C	< 240 HB	≤ 830	1.00
		P2.3		Containing > 0.55 % C	< 300 HB	≤ 1030	0.89
	P3	P3.1	Alloy steel (carbon steels with an alloying content ≤ 10 %)	Annealed	< 180 HB	≤ 620	0.92
		P3.2		Hardened and tempered	180 – 260 HB	> 620 ≤ 900	0.74
		P3.3			260 – 360 HB	> 900 ≤ 1240	0.63
	P4	P4.1	Tool steel (special alloy steel for tools, dies and molds)	Annealed	< 26 HRC	≤ 900	0.55
P4.2		Hardened and tempered		26 – 39 HRC	> 900 ≤ 1240	0.47	
P4.3				39 – 45 HRC	> 1240 ≤ 1450	0.38	
M	M1	Ferritic stainless steel (straight chromium non-hardenable alloys)	Annealed	< 160 HB	≤ 520	1.22	
				160 – 220 HB	> 520 ≤ 700	1.03	
	M2	Martensitic stainless steel (straight chromium hardenable alloys)	Quenched and tempered	< 200 HB	≤ 670	1.08	
				200 – 280 HB	> 670 ≤ 950	0.89	
				280 – 380 HB	> 950 ≤ 1300	0.75	
	M3	Austenitic stainless steel (chromium-nickel and chromium-nickel-manganese alloys)	Precipitation-hardened	< 200 HB	≤ 750	1.00	
				200 – 260 HB	> 750 ≤ 870	0.86	
				260 – 300 HB	> 870 ≤ 1040	0.77	
	M4	M4.1	Austenitic-ferritic (DUPLEX) or super-austenitic stainless steel		< 300 HB	≤ 990	0.75
		M4.2	Precipitation hardening austenitic stainless steel		300 – 380 HB	≤ 1320	0.64
K	K1	Gray iron or Automotive Gray iron (GG) (iron-carbon castings with a lamellar graphite microstructure)	Ferritic or ferritic-pearlitic	< 180 HB	≤ 190	1.35	
			Ferritic-pearlitic or pearlitic	180 – 240 HB	> 190 ≤ 310	1.00	
			Pearlitic	240 – 280 HB	> 310 ≤ 390	0.75	
	K2	Malleable iron (GTS/GTW) (iron-carbon castings with a graphite-free microstructure)	Ferritic	< 160 HB	≤ 400	1.39	
			Ferritic or pearlitic	160 – 200 HB	> 400 ≤ 550	1.13	
			Pearlitic	200 – 240 HB	> 550 ≤ 660	0.90	
	K3	Ductile iron (GGG) (iron-carbon castings with a nodular graphite microstructure)	Ferritic	< 180 HB	≤ 560	1.23	
			Ferritic or pearlitic	180 – 220 HB	> 560 ≤ 680	0.94	
			Pearlitic	220 – 260 HB	> 680 ≤ 800	0.76	
	K4	K4.1	Austenitic gray iron (ASTM A436) (iron-carbon alloy castings with an austenitic lamellar graphite microstructure)		< 180 HB	≤ 190	1.14
				< 240 HB	≤ 740	0.86	
K4.2		Austenitic ductile iron (ASTM A439 or ASTM A571) (iron-carbon alloy castings with an austenitic nodular graphite microstructure)		< 280 HB	> 840 ≤ 980	0.63	
				280 – 320 HB	> 980 ≤ 1130	0.54	
				320 – 360 HB	> 1130 ≤ 1280	0.45	
K5	K4.3	Austempered ductile iron (ASTM A897) (iron-carbon alloy castings with an ausferrite microstructure)		< 180 HB	≤ 400	1.29	
				180 – 220 HB	> 400 ≤ 450	0.97	
				220 – 260 HB	> 450 ≤ 500	0.75	
N	N1	Commercially pure wrought aluminium		< 60 HB	≤ 240	1.33	
			Wrought aluminium alloys	Half hard tempered	60 – 100 HB	> 240 ≤ 400	1.00
				Full hard tempered	100 – 150 HB	> 400 ≤ 590	0.67
	N2	Cast aluminium alloys		< 75 HB	≤ 240	0.67	
				75 – 90 HB	> 240 ≤ 270	0.60	
				90 – 140 HB	> 270 ≤ 440	0.43	
	N3	N3.1	Free-cutting copper-alloys materials with excellent machining properties		–	–	0.70
		N3.2	Short-chip copper-alloys with good to moderate machining properties		–	–	0.41
		N3.3	Electrolytic copper and long-chip copper-alloys with moderate to poor machining properties		–	–	0.21
	N4	N4.1	Thermoplastic polymers		–	–	0.70
N4.2		Thermosetting polymers		–	–	0.27	
N4.3		Reinforced polymers or composites		–	–	0.29	
N5	N5.1	Graphite		–	–	1.00	
S	S1	Titanium or titanium alloys		< 200 HB	≤ 660	1.94	
				200 – 280 HB	> 660 ≤ 950	1.72	
				280 – 360 HB	> 950 ≤ 1200	1.44	
	S2	Fe-based high-temperature alloys		< 200 HB	≤ 690	1.33	
				200 – 280 HB	> 690 ≤ 970	1.17	
	S3	Ni-based high-temperature alloys		< 280 HB	≤ 940	1.00	
				280 – 360 HB	> 940 ≤ 1200	0.83	
	S4	Co-based high-temperature alloys		< 240 HB	≤ 800	0.78	
			240 – 320 HB	> 800 ≤ 1070	0.67		
H	H1	Chilled cast iron		< 440 HB	–	1.52	
				< 55 HRC	–	0.90	
	H2	Hardened cast iron		> 55 HRC	–	0.77	
				< 51 HRC	–	1.00	
	H3	Hardened steel < 55 HRC		51 – 55 HRC	–	0.82	
				55 – 59 HRC	–	0.64	
	H4	Hardened steel > 55 HRC		> 59 HRC	–	0.54	

SIMPLY RELIABLE

As a professional you can judge the quality of work by just looking at the chip. Our chip is a clean and uncomplicated shape that in itself tells a story. It is a clear and consistent signal and that's why we use it as a symbol for being **Simply Reliable**.

DORMER PRAMET

www.dormerpramet.com



**CONTACTS TO LOCAL
SALES SUPPORT
ALWAYS UP TO DATE!**



DP-BRO-NEWS-2024-EN

FOLLOW US...



ONLINE



SEGMENTS



LIBRARY APP.



CALCULATOR APP.

